

# Teck

## Sä Dena Hes Mine, Yukon Territory 2017 Dam Safety Inspection

Prepared for

Teck Resources Limited



Prepared by

 **srk** consulting

SRK Consulting (Canada) Inc.  
December 2017

# Sä Dena Hes Mine, Yukon Territory 2017 Dam Safety Inspection

December 2017

**Prepared for**

Mr. Gerry Murdoch, Legacy Properties  
Teck Resources Limited  
601 Knighton Road  
Kimberley, BC V1A 3E1  
Canada

Tel: +1 250 427 8408  
Web: [www.teck.com](http://www.teck.com)

**Prepared by**

SRK Consulting (Canada) Inc.  
2200-1066 West Hastings Street  
Vancouver, BC V6E 3X2  
Canada

Tel: +1 604 681 4196  
Web: [www.srk.com](http://www.srk.com)

Project No: 1CT008.065

File Name: SDH\_DSI\_Report\_1CT008-065\_20171218\_PMH

Copyright © SRK Consulting (Canada) Inc., 2017



## Executive Summary

This report presents the results of the 2017 Annual Dam Safety Inspection (DSI) of the structures and features associated with the Tailings Management Area (TMA) that forms part of the closed Sä Dena Hes mine located near Watson Lake, Yukon. The only remaining tailings retaining embankment at the closed site is the North Dam. A small dyke referred to as the Sediment Retaining Structure (SRS) was also retained after closure of the site to collect any sediment that would be generated from the till cap that was placed over the exposed tailings. Other structures included in the DSI scope are a series of newly constructed (2014) ripped lined diversion channels and the reclaimed waste rock dumps at the location of the closed portals adjacent to the Main, Jewelbox and Burnick ore zones.

The inspection was completed by Mr. Peter Healey PEng., an associate of SRK Consulting (Canada) Inc., on July 25, 2017 while accompanied by Gerry Murdoch of Teck. Mr. Healey is the Engineer of Record (EoR) for the site and has been completing the annual dam inspections since 1992.

## Facility Description

The original TMA consisted of three earth structures, which were referred to as the North Dam, the South Dam and the Reclaim Dam. The North and South dams, which impounded the tailings, were constructed between July 1990 and October 1991. The starter dams for both structures were built to a height of about 13 metres.

In addition to the North and South Dams, a Reclaim Dam was built to detain supernatant water decanted from the tailings pond. The mine operation involved recycling of the detained water to the mill, with a controlled discharge when required into the adjacent Camp Creek from April to October each year.

Operations at Sä Dena Hes mine, which commenced in July 1991, were suspended in December 1992 due to low lead and zinc prices. Decommissioning of the site began in 2014 and was completed in 2015.

## Key Hazards and Consequences

As a required component of a dam safety inspection, the following key hazards at the site were identified and the consequences of different failure modes of the North Dam and the SRS were assessed:

- runoff from extreme precipitation events,
- seismic events,
- ice build up and debris in the SRS spillway,
- flow capacity of the SRS spillway, and
- potential for liquefaction of the tailings.

The key failure modes assessed included:

- Dam Overtopping
- Piping
- Slope Stability

The assessment concluded that the North Dam and the SRS Dyke are in good condition, meet current expectations and fall within acceptable guidelines for stability.

## **Dam Consequence Classifications**

The last Dam Safety Review was carried out by AMECFW (now the Wood Group) in 2015. Based on this review, the CDA Dam Consequence Classification of the North Dam was changed from “Low” to “Significant”. This classification does not indicate a risk of failure, but rather the consequence of failure in the extremely unlikely event of a failure. This review concluded that there were no dam safety or stability issues associated with the North Dam and that the dam was in good condition. The Consequence Classification of the Sediment Retaining Structure is “Low”.

The next dam safety review is scheduled for 2020.

## **Key Observations**

### **North Dam**

The North Dam is in good condition and shows no signs of deformation or abnormal settling. The downstream slope of the dam shows no signs of surficial movement or erosion nor is there any sign of bulging at the downstream toe.

The piezometers and settlement gauges on the North Dam are in good condition and continue to function as designed. The seasonal fluctuations recorded in the latter part of 2016 and most of 2017 in the piezometers are consistent with those observed in previous years.

The readings taken of the settlement gauges in the North Dam indicate that there has been no significant settlement of the embankment over the 24-year period that readings have been taken, with settlement readings varying to a maximum of 51 mm (or less than 1% of the total height of the dam) from the initial readings taken in 1993.

### **Sediment Retaining Structure**

The SRS is in good physical condition and the spillway is functioning in accordance with design parameters.

## **Significant Changes**

There are no significant changes to the stability of either the North Dam or the SRS since they were constructed in 1991 and 2014 respectively.

## OMS Manual and the Emergency Preparedness and Response Plan (EPRP)

The OMS manual and the EPRP were reviewed and changes to both documents are recommended. None of these changes will alter the conclusions about the reviewed state of the facilities. In the OMS, the recommendations included changes to the design criteria of the North Dam and the SRS based on the updated dam consequence classification and the frequency of settlement readings for the gauges on the North Dam. In the EPRP, the recommendations included changes to the emergency procedures for the TSF now that the mine has no personnel and no regular surveillance.

It is anticipated that both documents will be updated in the next six months to ensure conformance to Teck's internal guidelines.

## Deficiencies and Non-Conformance Table

There are no outstanding deficiencies or non-conformances from the 2016 or earlier DSI's. Recommendations from the 2017 dam safety inspection are summarized below. Both recommendations have been addressed and are now closed.

Structure	ID No.	Deficiency or Non Conformance	Applicable Regulatory or OMS Reference	Recommended Action	Priority (Teck 2014)	Recommended Deadline/ Status
North Creek Channel	2017-1	Beaver Dam at inlet to channel		Remove beaver dam in channel	3	End of 2017 / Completed July 27 Closed
Pipe Weir at MW-02	2017-2	6-inch pipe has rotated raising ponded water		Reconstruct weir to stabilise	3	End of 2017 / Completed July 27 Closed

### General Description of Priority Rankings<sup>1</sup>

Priority	Description
1	A high probability or actual dam safety issue considered immediately dangerous to life, health or the environment, or a significant regulatory concern.
2	If not corrected, could likely result in dam safety issues leading to injury, environmental impact or significant regulatory action; or, a repetitive deficiency that demonstrates a systematic breakdown of procedures.
3	Single occurrences of deficiencies or non-conformances that alone would not be expected to result in dam safety issues.
4	Best Management Practice as a suggestion for continuous improvement towards industry best practices that could further reduce potential risks. This typically includes ongoing construction items within the appropriate construction cycle.

<sup>1</sup> Based on the Health, Safety and Reclamation Code (HSRC) for Mines in British Columbia (2016 revision).

# Table of Contents

<b>1</b>	<b>Introduction</b>	<b>1</b>
1.1	Purpose, Scope of Work, and Methodology	1
1.2	Regulatory Requirements and Guidelines	2
1.3	Facility Description	2
1.3.1	Overview	2
1.3.2	North Dam	2
1.3.3	Sediment Retaining Structure (SRS)	3
1.3.4	Water Management Infrastructure	3
1.3.5	Tailings Cover	4
1.3.6	Waste Rock Dumps	4
1.4	Background Information and History	4
<b>2</b>	<b>Construction and Operation</b>	<b>6</b>
<b>3</b>	<b>Climate Data and Water Balance</b>	<b>6</b>
3.1	Review and Summary of Climate Data	6
3.1.1	Mean Annual Precipitation	6
3.1.2	2016 Analysis	7
3.1.3	Evaporation	8
3.2	Water Balance	8
<b>4</b>	<b>Site Observations</b>	<b>9</b>
4.1	Visual Observations	9
4.1.1	North Dam	9
4.1.2	Till Tailings Cover	10
4.1.3	North Creek	10
4.1.4	Sediment Retaining Structure	10
4.1.5	Drainage Channels	11
4.1.6	Burnick and Jewelbox Waste Rock Dumps	11
4.2	Instrumentation Review	11
4.2.1	Water Levels	11
4.2.2	Deformation/Settlement	11
4.3	Photographs	12
4.4	Pond and Discharge Water Quality	12
<b>5</b>	<b>Dam Safety Assessment</b>	<b>12</b>
5.1	Design Basis Review	12
5.1.1	North Dam	12
5.1.2	Sediment Retaining Structure	13

5.2 Hazards and Failure Modes Review.....	14
5.2.1 Dam Overtopping.....	14
5.2.2 Piping .....	14
5.2.3 Slope Stability .....	15
5.2.4 Surface Erosion.....	16
5.3 Dam Classification Review .....	17
5.4 Operations, Maintenance and Surveillance (OMS) Manual and Emergency Preparedness and Response Plan (EPRP) .....	19
<b>6 Summary and Recommendations.....</b>	<b>19</b>
6.1 Summary.....	19
6.2 North Dam.....	20
<b>7 References.....</b>	<b>22</b>

## List of Figures

Figure 1: Vicinity Map
Figure 2: TMA General Arrangement Map
Figure 3: North Dam Site Plan
Figure 4: North Dam Section 0+400
Figure 5: Sediment Retaining Structure Location Map
Figure 6: Sediment Retaining Structure Plan and Profile
Figure 7: Drainage Channel Plan
Figure 8: Drainage Channel Sections
Figure 9: North Drainage Channel Sections
Figure 10: Catchment Areas
Figure 11: Burnick Zone Plan View
Figure 12: Main Zone and Jewelbox Zone Plan View

## List of Tables

Table 3-1: Selected Meteorological Stations Associated with the Project Site.....	7
Table 3-2: Monthly Average Precipitation for the Site .....	7
Table 3-3: Monthly 2016 Precipitation for the Site .....	8
Table 3-4: Mean Monthly Lake Evaporation .....	8
Table 4-1: Summary of Survey Results for North Dam Settlement Gauges .....	12
Table 5-1: Design Criteria of the North Dam (Updated) .....	13
Table 5-2: Design Criteria for the SRS .....	14
Table 5-3: Target Levels for Earthquake Hazards/Factor of Safety, 2014 CDA Guidelines .....	15

---

Table 5-4: Stability Analysis Results.....	16
Table 5-5: CDA (2014) Dam Classification in Terms of Consequences of Failure.....	18
Table 6-1: Summary of Deficiencies and Non-Conformances.....	19

## **Appendices**

Appendix A – Photo Log

Appendix B – Piezometric Levels

## List of Abbreviations

AEP	Annual Exceedance Probability
CDA	Canadian Dam Association
CSP	Corrugated Steel Pipe
DCC	Dam Consequence Classification
DDRP	Detailed Decommissioning Reclamation Plan
DSI	Dam Safety inspection
DSR	Dam Safety review
ECCC	Environment Climate Change Canada
EoR	Engineer of Record
HSRC	Health, Safety and Reclamation Code
IDF	Inflow Flood Design
KCB	Klohn Crippen Berger
PGA	Peak Ground Acceleration
PMF	Probable Maximum Flood
PMP	Probable Maximum Precipitation
SRS	Sediment Retaining Structure
TMA	Tailings Management Area
TWRS	Tailings and Water Retaining Structures

# 1 Introduction

## 1.1 Purpose, Scope of Work, and Methodology

This report presents the results of the 2017 Annual Dam Safety Inspection (DSI) of the structures and features associated with the Tailings Management Area (TMA) that forms part of the closed Sä Dena Hes mine located near Watson Lake, Yukon. The work was carried out in accordance with our proposal dated March 21, 2017 and Teck PO # 9104, and Teck's Guideline for Tailings and Water Retaining Structures (Teck 2014). The work was authorized by Mr. Gerry Murdoch, Teck Resources Limited (Teck).

Mr. Peter Healey PEng, an associate of SRK Consulting (Canada) Inc., completed the site inspection on July 25, 2017 while accompanied by Gerry Murdoch. Mr. Healey is the Engineer of Record (EoR) for the site and has been completing the annual dam inspections since 1992.

The scope of the work consisted of:

- A visual inspection of the physical condition of the following structures and features to identify any deficiencies and non-conformances:
  - The North Tailings Dam
  - The decommissioned North Creek Dyke and Second Crossing
  - The relocated Camp Creek Diversion Channel
  - The North Channel and South Channels
  - The Sediment Retaining Structure (SRS)
  - The Burnick, Main and Jewelbox Waste Rock Dump areas
- A review of the Operation, Maintenance and Surveillance Manual (OMS) and Emergency Preparedness and Response Plan (EPRP) for the TMA
- A review of the Dam Consequence Classifications
- A review of the site inspection forms provided by Teck
- A review of the piezometer and settlement records of the North Dam provided by Teck
- A review of the 2015 Dam Safety Review (DSR) carried out by AMEC Foster Wheeler (AMECFW), now the Wood Group.

It should be noted that all elevations referenced in this report are based on a datum that was established during a LiDAR survey carried out in 2012. The original site datum used to design and build the structures in the early 90's was about 2 m lower than the 2012 datum. All previous inspection reports, prior to 2014, used the 1990 datum.

## 1.2 Regulatory Requirements and Guidelines

This DSI addresses the performance of the TMA and the associated water management infrastructure in accordance with the following regulatory requirements and guidelines, which in combination, fall within Teck's internal requirements included in Teck's Tailings and Water Retaining Structures (TWRS) guideline and policy:

- Canadian Dam Association (CDA) Dam Safety Guidelines 2007 (2013 Edition)
- Canadian Dam Association (CDA) Application of Dam Safety Guidelines to Mining Dams. Technical Bulletin, 2014
- The Yukon Territory Sä Dena Hes Water Licence (QZ99-045). New Licence issued April 2017 (QZ16-051)
- The Yukon Territory Sä Dena Hes Quartz Mining Licence (QML-0004)

## 1.3 Facility Description

### 1.3.1 Overview

This section provides a description of the components remaining at the mine site after the TMA was decommissioned in 2014 and 2015. A map showing the overall mine site is provided on Figure 1. A general arrangement map of the TMA is provided in Figure 2.

### 1.3.2 North Dam

The North Dam is approximately 15 m high with a crest elevation of 1,100 m, a crest length of about 260 m, and a crest width of 10 m. A site plan and section through the dam are shown in Figures 3 and 4. The North Dam for this report is considered a mining dam as it is a barrier constructed for the retention of tailings (CDA 2014).

Most of the tailings lie within the northern half of the TMA above the original cofferdam, which has since been removed. The tailings behind the North Dam were capped with a till cover in 2014. The cover was graded flush with the crest of the dam and graded south toward the SRS. A few small low lying areas remain within the cover that seasonally collect water, but overall the North Dam has not retained water since the mine decommissioning was completed. Given the cover grades away from the dam crest, the dam would only need to retain ponded water under extreme conditions as discussed below.

In 2016, SRK carried out a hydrological study (SRK 2017) to assess the likelihood of overtopping of the North Dam in the event of a design flood event. The results indicated that during an extreme case, such as the Probable Maximum Flood (PMF), the North Dam crest is not overtopped. Although the backwater effect arising from a blockage scenario in the central channel does result in an increased flood extent, with ponded water reaching within a few centimetres of the dam crest, an overtopping scenario is not reached. The maximum depth of water would vary from 0.5 m in the central channel to less than 0.1 m adjacent to the upstream crest of the dam. The model predicted that during the peak of the event, water would only be lapping up

against the dam for about 12 hours before it dissipates. The minimum freeboard adjacent to the low point along the upstream edge of the crest at the peak of the event varied from 5 to 8 cm.

### 1.3.3 Sediment Retaining Structure (SRS)

The SRS was constructed by leaving in place a low-profile dyke composed of the former South Dam toe material. The SRS dyke is approximately 80 m in length and has a crest width of 4 m at an approximate elevation of 1,087.7 m. The upstream face of the SRS was graded to 2H:1V and the downstream face was graded to 2.5H:1V. While the SRS is only 5 m high, for this report it is also considered a mining dam as it is a barrier constructed for the retention of ponded water (CDA 2014). The depth of water behind the structure is about 1 m.

An emergency spillway was constructed through the SRS dyke to accommodate the 1 in 1000 year Inflow Design Flood (IDF) event and to convey runoff from the upstream catchment to the South Drainage Channel. The as-built spillway and drainage channel geometries are presented in Figures 5 and 6. The spillway channel invert elevation is 1,085.7 m and has a length of 33.3 m.

### 1.3.4 Water Management Infrastructure

#### Overview

Three drainage channels were built as part of the 2014 TMA decommissioning (see Figure 7). The longest of the three was constructed through the former Reclaim Dam and the pond area to route Camp Creek flows along its historical alignment. The other two drainages (the North Channel and the South Channel) were constructed to direct runoff from the covered tailings areas to the new Camp Creek Drainage Channel. There is also a drainage channel located down the middle of the cover that directs runoff from the tailings cover at the northern end of the TMA.

#### South Drainage Channel

The South Drainage Channel was constructed from the SRS spillway through the former South Dam and connects with the Camp Creek Drainage Channel. The channel length is about 230 m and it was installed with riprap erosion protection placed on top of a non-woven geotextile (see Figure 8). The channel is designed for the 1 in 1000-year IDF. Upstream and downstream sidslopes are 2:1 (H:V). Average grade of the channel is 0.04.

#### Camp Creek Drainage Channel

The Camp Creek Drainage Channel was constructed through the former Reclaim Dam and pond area to route Camp Creek flows along its historical alignment (see Figure 8). The channel length is about 940 m and it was installed with riprap erosion protection placed on top of a non-woven geotextile (see Figure 8). The channel is designed for the 1 in 1000-year IDF. Upstream and downstream sidslopes are 2:1 (H:V). Average grade of the channel is 0.05.

### **North Drainage Channel**

The North Drainage Channel was constructed along the east side of the former South Pond to convey water from the North Tailings Area to the SRS. Conveyed water is detained in the SRS to allow for sediments to deposit before the water is discharged into Camp Creek (see Figure 9). The channel length is about 300 m and it was installed with riprap erosion protection placed on top of a non-woven geotextile. The channel is designed for the 1 in 1000-year (IDF). Upstream and downstream sideslopes are 2:1 (H:V). Average grade of the channel is 0.03.

### **North Creek**

During operation of the mine, a dyke was built over the North Creek as a water storage facility for the mill. The dyke (see Figure 1 for location) was decommissioned in 2015 and a riprapped channel was built through the old dyke to convey the flow along North Creek to False Canyon Creek. A similar channel was also built downstream to convey the North Creek flow through a decommissioned access road.

#### **1.3.5 Tailings Cover**

The soil tailings cover discussed previously varies up to 2.2 m in depth. It covers all the exposed deposited tailings, specifically in the North Tailings Area and the tailings deposited in South Pond area. The cover was constructed of excavated dam fill material. It provides an effective means of controlling wind erosion of tailings and a growth medium over the tailings for revegetation. The cover was sloped away from the crest of the North Dam in a southerly direction towards the SRS. Water is no longer impounded behind the dam. A shallow swale was constructed down the middle of the cover to direct surface runoff on the cover to the SRS.

The total covered area of the TMA is 155,081 m<sup>2</sup>. The reclaimed North Tailings Area is 87,745 m<sup>2</sup>, the reclaimed South Pond including the grassy area is 28,444 m<sup>2</sup>, and the reclaimed Reclaim Pond is 38,892 m<sup>2</sup>.

#### **1.3.6 Waste Rock Dumps**

During operation of the mine, waste rock dumps were developed at each of the main portals, associated with the Main Zone, the Jewelbox Zone and the Burnick Zone ore bodies. At closure, the portals were closed off with waste rock, and the dumps were resloped to direct runoff away from the openings and to provide more stable conditions.

### **1.4 Background Information and History**

The original TMA, which extended from the North Dam to the South Dam covered an area of approximately 0.205 sq. km (Figure 2). During the operating life of the mine, approximately 700,000 tonnes of tailings were deposited into the impoundment, primarily at the northern end. The North and South dams, which impounded the tailings, were constructed between July 1990 and October 1991. The starter dams for both structures were built to a height of about 13 metres. Between the two dams, at the location of a topographic saddle, was a 2 m high cofferdam, which

had a gated culvert to control the flow of water and tailings from the northern half of the impoundment to the southern half.

In addition to the North and South Dams, a Reclaim Dam was built to detain supernatant water. A decant tower, in the South Tailings Pond, was used to discharge the supernatant water in the tailings pond into the Reclaim Pond through a 0.5 m diameter corrugated steel (CSP) decant pipe. The mine operation involved recycling of the detained water to the mill with a controlled discharge, when required, into the adjacent Camp Creek from April to October each year.

An open channel emergency spillway was located at the west side of the Reclaim Pond. This spillway was designed to accommodate the design flood event from the TMA catchment only. Flow through this spillway was directed to the primary spillway system, which was part of the Camp Creek diversion channel constructed along the west side of the Reclaim Pond. This primary spillway consisted of two 1,200 mm diameter CSP culverts and was designed to accommodate the 1 in 200-year Inflow Design Flood (IDF). Camp Creek was diverted into the diversion channel and discharged through the two culverts into a riprap lined exit chute.

An emergency spillway was also located in the west abutment of the South Dam and was designed to accommodate the 200-year IDF. The spillway consisted of two 900 mm diameter CSP culverts. The discharge from the spillway entered the Reclaim Pond downstream via an unlined channel.

Two additional surface water diversions, the east and west interceptor ditches, were located on both sides of the TMA to intercept surface runoff from upslope of the TMA.

In March of 1992, the previous operators, Curragh Resources, built a rockfill buttress along the toe of the Reclaim dam to provide extra protection against sloughing and erosion of the toe due to seepage.

In September 1992, work commenced on a 2-metre raise of the South Dam to El. 1098. Work on the extension was shut down on October 14, 1992 because of the construction difficulties experienced due to sub-zero temperatures.

Operations at Sä Dena Hes mine, which commenced in July 1991, were suspended in December 1992 due to low lead and zinc prices.

During the care and maintenance period after the mine shut down in 1992, water was released from the tailings pond to the Reclaim Pond seasonally by way of syphons to maintain a safe operating level. Water was discharged from the Reclaim Pond to Camp Creek in accordance with the limits imposed by the Water License.

In 2003, Teck Cominco installed an HDPE pipeline through one of the spillway culverts as a siphon to facilitate the transfer of water from the South Tailings Pond.

With the 2014 decommissioning work, the TMA has been significantly modified. The Reclaim Dam was completely removed and the final excavated surface of the Reclaim Dam was graded to blend into the surrounded topography.

In 2014, most of the South Dam was removed to form the Sediment Retaining Structure (SRS). The decant tower and the pipe were decommissioned and removed to the on-site landfill. The South Dam overflow spillway was decommissioned by removing the two 900 mm diameter culverts that were disposed of at the landfill. Similarly to the decommissioning of the Reclaim Dam, the dam footprint was excavated to original ground (with exception of the SRS) and blended into the surrounded topography.

The Camp Creek Diversion Channel, exit chute, and culverts were decommissioned in 2015. The interceptor ditches were decommissioned in 2015.

Many of the access roads at the site have been decommissioned and access to the decommissioned Main Zone, Jewelbox and Burnick areas are via all-terrain vehicle or helicopter.

## **2 Construction and Operation**

After the 1992 shutdown of the mine, it never reopened and no more tailings were deposited into the TMA. Information on the decommissioning of the mine is provided in Section 1.4.

Teck conducts on-going care and maintenance of the TMA and the water management infrastructure at the site including the access road from the Robert Campbell Highway. Any trees or vegetation on the downstream slope of North Dam that do not conform to the guidelines in the OMS manual are trimmed or removed. Seepage at the toe of the North Dam is monitored monthly with sampling of water quality and measurement of flow. During the monthly inspections by the sampling team, an inspection of the North Dam and the SRS spillway is made to check for any blockages or subsidence.

## **3 Climate Data and Water Balance**

### **3.1 Review and Summary of Climate Data**

A detailed climate characterization study was recently carried out by SRK (SRK, 2017) to determine mean annual total precipitation for the Project site in absence of any site-specific data.

#### **3.1.1 Mean Annual Precipitation**

A regional analysis and regression analysis were performed using the nearby meteorological stations from Environment Climate Change Canada (ECCC). The data were compiled in R Studio Software, generating the mean annual precipitation (MAP) for each station. Table 3-1 presents the station locations relative to the site, as well as their respective MAP estimate. Correction for under-catch in the precipitation measurements is prepared daily by Environment Canada for many, but not all meteorological stations, as noted in Table 3-1.

**Table 3-1: Selected Meteorological Stations Associated with the Project Site**

Station ID	Station Name	Longitude [deg]	Latitude [deg]	Elevation [m]	Dist. from Site [km]	MAP [mm]	Years of Info [yrs]	Under-Catch Factor Available
2101200	Watson Lake A	-128.82	60.12	687.4	46.66	424.0	74	YES
2101135	Tuchitua	-129.22	60.93	723.9	47.90	493.6	40	YES
2100FCG	Hour Lake	-129.13	61.18	890.0	72.93	544.8	28	NO
2101081	Swift River	-131.18	60.00	891.2	141.74	564.7	37	YES
1191440	Cassiar	-129.83	59.28	1077.5	150.35	728.2	36	YES
1197530	Smith River A	-126.43	59.90	673.0	151.68	466.9	25	NO
2203922	Tungsten	-128.25	61.95	1143.0	160.38	637.0	22	NO
2101100	Teslin A	-132.74	60.17	705.0	217.87	332.9	56	YES
1192340	Dease Lake	-130.01	58.43	806.6	243.67	419.9	61	YES
1195250	Muncho Lake	-125.77	58.93	836.5	248.96	508.1	40	NO
2100200	Carcross	-134.70	60.17	660.0	324.42	248.4	60	NO
1208202	Todagin Ranch	-130.07	57.60	899.0	334.45	419.4	18	NO
2100460	Drury Creek	-134.39	62.20	609.0	348.27	372.9	35	YES

Source:  
file:///Z:/01\_SITES/Sa\_Dena\_Hes/1CT008.061\_2016\_DSR\_Studies/Task%20100\_Hydrology/IR\_Analysis/Hydrology/Precipitation\_Hydrology\_at\_Sa\_Dena\_Hes.docx

The regression analysis predicted a MAP for the site of 646 mm based on an elevation of 1080 masl. Monthly average precipitation for the site is summarized in Table 3-2 based on the site MAP of 646 mm and the monthly distribution from the Cassiar station (SRK 2017).

**Table 3-2: Monthly Average Precipitation for the Site**

Location	Jan	Feb	Mar	Apr	May	Jun	Jul	Aug	Sep	Oct	Nov	Dec	Annual
Site	58.1	49.1	39.4	23.9	33.6	47.8	60.7	63.3	71.7	75.6	58.8	64.6	646

### 3.1.2 2016 Analysis

The Watson Lake A station is used as the reference station as it is the most representative station close to the site that is currently active. Total precipitation recorded at Watson Lake A in 2016 was reported as 275 mm by ECCC, which is drier than average conditions. Using the undercatch correction factor of 1.13 (SRK 2017), total corrected precipitation for 2016 at Watson Lake was 311 mm.

A ratio of Watson Lake MAP vs. calculated Site MAP was applied to convert the 2016 Watson Lake precipitation to a representative MAP for the Site. Based on the corrected undercatch MAP for Watson Lake of 479.3 mm, the adjustment factor for the site is 1.42, which equates to an approximate annual precipitation of 442 mm in 2016 at the site as shown in Table 3-3.

**Table 3-3: Monthly 2016 Precipitation for the Site**

Location	Jan	Feb	Mar	Apr	May	Jun	Jul	Aug	Sep	Oct	Nov	Dec	2016/Annual
Site	39.8	33.6	26.9	16.3	23.0	32.7	41.5	43.3	49.0	51.7	40.2	44.2	442

### 3.1.3 Evaporation

The network of evaporation stations is sparse in the Yukon and northern British Columbia. Potential evapotranspiration was calculated using the Morton (1983) methodology, utilising meteorological parameters measured at the nearby Watson Lake weather station, with solar radiation data obtained from the Whitehorse Airport station. Using this method, the annual lake evaporation rate was estimated to be 483 mm as shown in Table 3-4. Due to the limited variability of lake evaporation from year to year, the average annual values are applied in the annual water balance.

**Table 3-4: Mean Monthly Lake Evaporation**

	Jan	Feb	Mar	Apr	May	Jun	Jul	Aug	Sep	Oct	Nov	Dec	Year
Morton-Shallow Lake [mm]	10.4	8.4	18.2	41.4	75.5	96.9	99.5	71.6	33.4	11.0	7.2	9.7	483.2

Source: \\Z:\01\_SITES\Sa\_Dena\_Hes\1CT008.057\_2016\_Geotech\_Inspection\080\_Deliverables\1CT008.057\_Report\010\_Text\2016\_SDH\_GeotInsp\_Report\_1CT008-057\_20170404\_pmh.docx

## 3.2 Water Balance

The TMA at Sä Dena Hes has been decommissioned and there are no active ponds other than the small sediment pond at the SRS. The SRS pond has a maximum surface area of about 1600 m<sup>2</sup> during the freshet high flow period. An emergency overflow spillway was also built through the SRS to accommodate the 1 in 1000-year flood event. The catchment area for the SRS spillway is 1.33 km<sup>2</sup> as shown on Figure 10.

A simplified mean annual average water balance calculation for the catchment above the SRS dyke is summarized below, based on data compiled for the recent SRK hydrological study (SRK 2017) and the following assumptions:

- Inflow from the surrounding hillside catchment (1.17 km<sup>2</sup>) based on 60% of the MAP
- Inflow from the tailings till cover (0.16 km<sup>2</sup>) based on 50% of the MAP
- Direct precipitation input to the SRS pond based on 100% of the MAP
- Outflow from the SRS pond based on annual pond evaporation (483 mm) and seepage losses (estimated at 0.5 l/s)

Average annual water balance from the SRS Pond:

- MAR from the hillside catchment above the SRS = 453,000 m<sup>3</sup>
- MAP on the sediment pond surface = 1034 m<sup>3</sup>
- MAR on the tailings cover material = 50,388 m<sup>3</sup>

- Total Annual Inflow: 505,600 m<sup>3</sup>
- Total Outflow (seepage and pond evaporation): 16,500 m<sup>3</sup>
- Net Annual Volume (over spillway): 489,100 m<sup>3</sup>

Using the estimated 2016 MAP for the site, the 2016 annual water balance is summarized below:

- MAR from the hillside catchment above the SRS = 309,900 m<sup>3</sup>
- MAP on the sediment pond surface = 710 m<sup>3</sup>
- MAR on the tailings cover material = 35,400 m<sup>3</sup>
- Total Annual Inflow: 346,000 m<sup>3</sup>
- Total Outflow (seepage and pond evaporation): 16,500 m<sup>3</sup>
- Net Annual Volume (over spillway): 329,500 m<sup>3</sup>

## 4 Site Observations

### 4.1 Visual Observations

The weather during the inspection was sunny and warm.

#### 4.1.1 North Dam

A site plan and a section of the North Dam are presented on Figures 3 and 4.

The crest of the North Dam (Photo 1), is in good condition. It shows no signs of deformation or abnormal settling. The downstream slope of the dam (Photo 2) shows no signs of surficial movement or erosion nor is there any sign of bulging at the downstream toe. Oversized trees observed during a previous dam safety inspection in 2015 had been removed in accordance with the routine maintenance specified in the OMS manual.

The piezometers and settlement gauges (Photos 3, 4 and 5) on the North Dam are in good condition and continue to function as designed. The orange coloured piezometer caps provide visible identification for the monitoring team. Piezometer 4A at the toe of the dam has not been updated with the new caps, and the steel protective cap has settled over time below the top of the PVC pipe.

Along the downstream toe of the North Dam there is an 80 m long seepage zone (Photo 6). Seepage from this zone is collected at a monitoring station referred to as MH-02 and is a combination of groundwater discharge from the surrounding hillsides to the west and minimal seepage flow from the impoundment. The monitoring station consists of a 6-inch diameter steel pipe (Photo 7) embedded in sandbags. It was noted that the pipe had rotated and was not functioning as designed. Photo 8 shows the redundant slope displacement monitoring pins, which have survived the elements.

#### **4.1.2 Till Tailings Cover**

Photo 9 shows a view looking south of the tailings cover at the north end of the TMA. The cover has an overall gentle downslope gradient away from the North Dam. A drainage channel was constructed down the middle of the cover to assist in directing runoff away from the dam. At the time of the site inspection, water was flowing south along the channel, as shown in Photos 10 and 11.

#### **4.1.3 North Creek**

The riprapped channel conveys the North Creek over the location of the decommissioned North Creek Dyke. It was noted at the inlet of the channel that beavers had built a dam (Photo 12). Photo 13 shows a view downstream of the channel. At the outlet of the channel (Photo 14) some of the riprap has been dislodged by the flow, exposing a small area of the underlying filter fabric. This was noticed during last year's inspection and it has not deteriorated. The channel remains stable and no remediation is required. Photo 15 shows a view looking upstream along the channel.

Below the above channel is a second riprapped channel that was built following the removal of the two culverts as part of the site reclamation (Photo 16). The channel is stable and requires no remediation.

#### **4.1.4 Sediment Retaining Structure**

The Sediment Retaining Structure (SRS) was built during the decommissioning of the South Dam between 2014 and 2015. Figures 5 and 6 provide a site plan and sections of the SRS.

During the 2015 inspection, a small subsidence was observed in the lower portion of the exit chute from the spillway. The material displaced was retained by the geotextile filter fabric and some of the riprap had moved. Teck repaired the spillway after the 2015 inspection by placing additional riprap from the cofferdam located upstream of the pond. No further subsidence was noted during this year's inspection.

The GeoJute erosion protection and the riprap buttress along the downstream toe of the SRS that Teck installed last year (Photo 17) have reduced the risk of further erosion of the downstream slope or the downstream toe of the structure.

Seepage from the hillside area to the east of the structure is still evident along the downstream toe of the SRS (Photo 18).

The pond was very clear at the time of our inspection and there was no real evidence of any silt buildup in the pond.

Photo 20 shows the riprap buttress along the toe of the dyke. A small boil was noted (Photo 21) at the toe of dyke which was also noted during last year's inspection. The activity is minor and no remediation is required.

#### **4.1.5 Drainage Channels**

The riprapped drainage channels (the North Channel, the Camp Creek channel and the South Channel) were constructed during the TMA decommissioning in 2014. Figure 7 provides a plan view of the three channels. SRK inspected each of the channels for any signs of subsidence and movement of the riprap erosion protection.

Photo 19 shows the South Channel looking south. Photos 22 and 23 show the Camp Creek channel. No movement of the riprap or subsidence was evident in any of the channels.

#### **4.1.6 Burnick and Jewelbox Waste Rock Dumps**

SRK inspected the resloped Main Zone and Jewelbox waste dumps (Photo 24 and Figure 12). It was noted that at the toe of the dumps, there was evidence of some erosion (Photos 25 and 26). While the erosion does not impact the stability of the dumps, SRK recommended that marked stakes be installed at the base of the erosion to monitor the erosion trend over time. Teck has installed the stakes and they will be inspected in 2018.

SRK also inspected the Burnick waste dumps at the locations of the reclaimed 1200 and 1300 portals shown in Figure 11. The dumps were recontoured to provide added long-term stability. No subsidence of the slopes was noted.

Minor settlement of the fill that was placed over the 1200 portal was noted (Photo 27). This settlement is to be expected and no remediation is required.

### **4.2 Instrumentation Review**

#### **4.2.1 Water Levels**

The water levels in the North Dam piezometers are recorded monthly and the 2017 data are presented in Appendix B. The results are reviewed by the EoR after each monitoring session. Figure B1 provides a plot of seasonal water levels from 2011 for Piezometers NDW-1A, 2A, 3A and 4A compared to the maximum safe levels established for the North Dam (as listed in the OMS Manual). The seasonal fluctuations recorded this year in the piezometers are consistent with those in previous years and are within acceptable tolerance limits. Table B1 (Appendix B) presents the water levels from 2016 to July 2017.

The peak levels recorded in July 2017 are plotted on the dam section shown on Figure 4.

In the new water license, which was issued April 2017, piezometer levels are required to be measured bi-monthly.

#### **4.2.2 Deformation/Settlement**

Teck has been surveying the settlement gauges on the North Dam since 1993. Results are shown on Table 4.1. The last set of readings taken using the 1990 datum was completed in 2010. A recent set of readings was completed in 2017 based on the 2012 datum. The readings are consistent with those observed in previous years, with settlement readings varying to a

maximum of 51 mm (or less than 1% of the total height of the dam) from the initial readings taken in 1993. The recorded settlements are considered acceptable for a small earthen dam and would not compromise the structural integrity of the dam.

**Table 4-1: Summary of Survey Results for North Dam Settlement Gauges**

Date	NDS3	NDS1	NDS2
August/93	1098.639	1098.501	1098.613
July/94	1098.637	1098.502	1098.589
August/95	1098.690	1098.545	1098.663
July/96	1098.637	1098.493	1098.609
August/97	1098.637	1098.496	1098.618
October/98	1098.627	1098.482	NA
October/02	1098.619	1098.481	1098.607
June/05	1098.637	1098.479	1098.587
June/06	1098.63	1098.45	1098.57
August/07	1098.786	1098.454	1098.489
June/08	1098.626	1098.482	1098.597
June/09	1098.625	1098.469	1098.587
June/10	1098.59	1098.47	1098.60
August/15	1100.572	1100.412	1100.524
September/15	1100.548	1100.391	1100.512
2016	1100.572	1100.425	1100.547
2017	1100.573	1100.427	1100.547

Note: 2015, 2016 and 2017 readings are based on the 2012 datum.

### 4.3 Photographs

A photographic log was taken during the site inspection. Photos are provided in Appendix A and are referenced in Section 4.1.

### 4.4 Pond and Discharge Water Quality

The Sediment pond at the SRS is the only pond on the site. Water quality in the pond is monitored monthly by Teck and the results are presented in the Sä Dena Hes Annual Water License Report.

## 5 Dam Safety Assessment

### 5.1 Design Basis Review

#### 5.1.1 North Dam

The original design of the starter dam for the North Dam required a crest elevation of 1,100 m with an ultimate dam design crest elevation of 1,106 m. However, this ultimate design crest

elevation was modified in subsequent revisions to the mine plan to El. 1,104 m. A summary of the design criteria for the North Dam is provided in Table 5-1. The design criteria were also updated to reflect changes in the CDA 2014 Technical Bulletin, Dam Consequence Classification.

**Table 5-1: Design Criteria of the North Dam (Updated)**

Design Crest Elevation (Ultimate)	Not applicable
Starter Dam Crest (Existing)	1,100 m
Top of Till Core Elevation (Ultimate)	Not applicable
Maximum Operating Tailings Level (ultimate)	Not applicable
Maximum Operating Pond Level (Ultimate)	Not applicable
Spillway Invert Elevation	No emergency spillway in dam
Design Operating Freeboard	Not applicable
Design Seepage (SRK/AMCL, 2000)	35-50 L/min
Tailings Storage Capacity (Ultimate)	Not applicable
Dam Consequence Classification (2015 DSR)	Significant
Target Earthquake Level (CDA, 2014) (Passive care) Seismic Event	1 in 2475 year (PGA = 0.203g)
Target FOS (CDA, 2014)	1.5 (static); 1.0 (pseudo-static)
Target Flood Levels (CDA, 2014)	1/3 between the 1,000-year event and the PMF

Source: \\Z:\01\_SITES\Sa\_Dena\_Hes\1CT008.057\_2016\_Geotech\_Inspection\080\_Deliverables\1CT008.057\_Report\010\_Text\2016\_SDH\_GeotInsp\_Report\_1CT008-057\_20170404\_pmh.docx

### 5.1.2 Sediment Retaining Structure

The SRS spillway was designed to accommodate the 1 in 1000-year design flood. The SRS currently has a “Low” Consequence Classification. CDA (2014) recommends that the inflow design flood (IDF) for a low consequence dam class that is expected to remain in Construction, Operation & Transition Phase would be the 1 in 100-year event as referenced in Table 3-2 of the CDA 2014 Technical Bulletin. However, as the SRS will be in a “Closure-Passive Care Phase” for an extended period under infrequent surveillance, the IDF for the spillway was raised to the next highest dam classification level, the 1 in 1000-year event as referenced in Table 4-1 of the CDA 2014 Technical Bulletin.

Similarly, the target PGA for the SRS is 0.146 g.

A summary of the design criteria for the SRS is provided in Table 5-2 below.

**Table 5-2: Design Criteria for the SRS**

Original Design Crest Elevation	El. 1086.7 m
As Built Crest Elevation	El. 1087.7 m
Original Design Spillway Invert Elevation	El. 1085.0 m
As Built Spillway Invert Elevation	El. 1085.7 m
Crest Length	80 m
Design Operating Freeboard	1 m
As Built Operating Freeboard	1 m
Dam Consequence Classification	Low
Operating Pond Level	El. 1085 m
Target Earthquake Level (CDA, 2014) (Passive Care)	1 in 1000 years (PGA = 0.146g)
Target FOS (CDA 2014)	1.5 (static); 1.0 (pseudo-static)
Target Flood Levels (CDA 2014) (Passive Care)	1 in 1000 years

## 5.2 Hazards and Failure Modes Review

As a permanently closed site, structures at Sä Dena Hes mine site that have the potential to endanger human life or create environmental damage were either removed or upgraded to enhance long-term physical stability. This section of the DSI reviews the hazards that have been identified for the North Dam and the SRS and provides an assessment of the safety of these structures relative to the potential failure modes listed in the CDA (2014) Technical Bulletin.

Key hazards identified for the North Dam and SRS include runoff from extreme precipitation events, seismic events, ice buildup and debris in the SRS spillway, potential for liquefaction of the tailings and flow capacity of the SRS spillway. The following sections assess the potential failure modes for each structure.

### 5.2.1 Dam Overtopping

The recent hydrological studies completed by SRK (SRK 2016a) concluded that there is no risk of overtopping of the North Dam even in an “extreme worst case” Probable Maximum Precipitation (PMP) event with none of the existing drainage features such as water diversions functioning.

The spillway in the SRS is designed to accommodate the 1 in 1000 year IDF which meets the CDA 2014 target levels for flood hazards for “low” Dam Consequence Classification dams in the closure-passive care phase.

### 5.2.2 Piping

#### North Dam

The North Dam was built as a tailings retaining structure designed to allow seepage through the dam. The dam has three zones: an upstream low permeability compacted zone of silty till, a semi

pervious compacted central zone of sandy till and a compacted outer downstream shell of pervious sand and gravel. Underlying the dam is a native sandy, gravelly silt (till). There are no indicators of fines being washed through to dam, although there is some seepage evident at the downstream toe. This seepage is mixed in with historical spring activity that was noted during the construction of the dam and the annual dam inspections. The tailings placed up against the upstream face of the dam have significantly reduced the seepage loss since initial construction. Piezometric levels in the dam and in the foundation have varied seasonally since the mine shut down in 1992 and lower levels are expected over time as the till cap consolidates.

Given the lower hydraulic gradient now that the pond has been removed, the risk of piping is negligible.

## SRS

The pond behind the SRS has a maximum depth of about 1.5 m and the overall hydraulic gradient through the structure is low and corresponds to no piping potential. The seepage through the dyke is barely measurable. There is one small boil that has been noted at the downstream toe of the SRS dyke, but no loss of fines detected.

### 5.2.3 Slope Stability

Table 5-3 outlines the minimum FoS values for mining dams based on the guidelines in the CDA 2014 technical Bulletin.

**Table 5-3: Target Levels for Earthquake Hazards/Factor of Safety, 2014 CDA Guidelines**

Dam Rating	Care Type <sup>1</sup>	Event	AEP	Minimum Static FoS	Minimum Pseudo-Static FoS
Low	Transition	1 in 100 year	0.01	1.5	1.0
Low	Passive Care	1 in 1000 year	0.001	1.5	1.0
Significant	Transition	1 in 1000 year	0.001	1.5	1.0
Significant	Passive Care	1 in 2475 year	0.0004	1.5	1.0

**Notes:**

1. Active care assumes regular dam safety reviews, continual dam performance monitoring and the ability to respond to emergencies immediately. Passive care assumes no maintenance or monitoring occurs post-closure.

As the site is expected to remain in the Closure Passive Care phase for an extended period and as there is infrequent surveillance, the passive care targets have been adopted.

## North Dam

As discussed above, the North Dam is composed of compacted fill with a pervious downstream shell. The downstream slope is 2.5H:1V. Several stability analyses have been performed on this dam in the last 2 years.

In 2015, SRK completed a stability analysis of the North Dam to supplement a third-party review of the Dam Consequence Category for the dam.

The results of the stability analyses completed on the North Dam, which are shown in Table 5-4, show that the structure exceeds minimum FoS requirements for long-term static and pseudo-static stability for closed dams under passive care classified as having a “Significant” consequence of failure.

**Table 5-4: Stability Analysis Results**

Case	FoS
Long Term Static	1.6
Pseudo-Static (1 in 100 year)	1.5
Pseudo-Static (1 in 1000 year)	1.3
Pseudo-Static (1 in 2475 year)	1.2

In the above slope stability analysis, the seismic acceleration used in the calculation was one-half of the full Peak Ground Acceleration (PGA) or 0.203g. The application of the entire PGA value in the direction of failure is extremely conservative and represents the absolute worst-case scenario.

In 2016, SRK completed an updated post-liquefaction stability analysis of the North Dam. The stability analysis was completed to assess the stability of the North Dam following an earthquake event and assuming liquefaction of the tailings impounded by the dam during the seismic event.

The stability analysis concluded that tailings play no role in dam stability as the critical failure surface runs through the dam, which is constructed of engineered and not tailings material.

Based on the above analyses, the North Dam is stable under both static and seismic assessments.

## **SRS**

SRK also completed a stability analysis of the current configuration of the dyke under both static and pseudo-static conditions. The dyke has a maximum height of about 5 m and upstream and downstream slopes of 2H:1V slope and 2.5H:1V respectively. The maximum depth of the pond behind the dyke is about 1.7 m.

The seismic calculation was completed using a full horizontal loading of 0.146g which was based on the target level for earthquake hazards suggested by CDA 2014 guidelines for a low consequence class dam in the passive care phase. The results of the analysis indicated both static and pseudo static FOS that exceeded the target values in Table 5-3 above.

### **5.2.4 Surface Erosion**

#### **North Dam**

SRK completed a recent study to assess the erosion potential of the material on the downstream face. The study concluded that existing sand and gravel material exposed on the downstream

face is adequate to withstand the runoff from the 200-year, 24-hour rainfall event without any significant erosion.

### **SRS**

GeoJute fabric protection on the downstream face of the SRS is in good condition and provides adequate protection against surface erosion.

## **5.3 Dam Classification Review**

The first assessment of the Dam Consequence Classification (DCC) of potential failure of the dams and spillways associated with the TMA was completed by SRK for the 2000 Detailed Decommissioning Reclamation Plan (DDRP). The assessment was completed in accordance with the guidelines presented in the "Mine Reclamation in the Northwest Territory and the Yukon" (INAC 1992) and focused on the failure of the South Dam spillway and the failure of the North Dam. The failure of South Dam and the Reclaim Dam was not considered since they would be removed upon closure. The study concluded that the failure of the North Dam and the South Dam spillway would not pose a significant risk to public health and safety; there would be no loss of life expected, no damage to buildings and no loss to roads. The design criteria established for the design of the South Dam spillway and the stability of the North Dam was therefore based on the 1 in 1000 year IDF and the PGA for the 1 in 1000 seismic event respectively. No dam breach or inundation studies were carried out.

As part of the 2003 Dam Safety Review (DSR) completed by Klohn Crippen Berger (KCB), a screening level assessment of the DCC for the TMA was carried out so that the appropriate design criteria could be established for the DSR. The assessment was carried out in accordance with the 1999 CDA Dam Safety Guidelines and included a dam breach inundation analysis. The study concluded that all three dams (North, South and Reclaim) would be classified as Low Consequence facilities.

In 2010, a second DSR was carried out by Golder Associates, who also completed a screening level assessment so that a design criteria could be established for the 2010 DSR. The assessment was completed in accordance with the CDA 2007 Dam Safety Guidelines and included a conceptual dam breach and inundation study. Overall the assessment concluded that all three dams would be in the "significant" consequence class due to the potentially significant incremental losses on False Creek and Frances River.

Given the 2014 decommissioning activities associated with the TMA, SRK completed a dam breach and inundation study for the SRS dyke and the North Dam. The assessment concluded that by applying the CDA (2014) generalized guidelines shown in Table 5-5, incremental losses from a breach of the North Dam and SRS dyke would place the structures in the "Low" Consequence class. The attribution of that class to the North Dam and the SRS is based on the following consequence criteria:

- There is no population at risk downstream of the facility or near the dam or in the expected path of any water releases;

- No loss of human life would be expected from the failure;
- No local or regional infrastructure or services would be impacted by a failure; and
- There would be minimal short term loss and no long-term loss.

**Table 5-5: CDA (2014) Dam Classification in Terms of Consequences of Failure**

Dam Class	Population at Risk [note 1]	Incremental Losses		
		Loss of Life [note 2]	Environmental and Cultural Values	Infrastructure and Economics
Low	None	0	Minimal short-term loss No long-term loss	Low economic losses; area contains limited infrastructure or services
Significant	Temporary only	Unspecified	No significant loss or deterioration of fish or wildlife habitat Loss or marginal habitat only Restoration or compensation in kind highly possible	Losses to recreational facilities, seasonal workplaces, and infrequently used transportation routes
High	Permanent	10 or fewer	Significant loss or deterioration of <i>important</i> fish or wildlife habitat. Restoration or compensation in kind highly possible	High economic losses affecting infrastructure, public transportation, and commercial facilities
Very high	Permanent	100 or fewer	Significant loss or deterioration or <i>critical</i> fish or wildlife habitat Restoration or compensation in kind possible but impractical	Very high economic losses affecting important infrastructure or services (e.g., highway, industrial facility, storage facilities for dangerous substances)
Extreme	Permanent	More than 100	Major loss of <i>critical</i> fish or wildlife habitat Restoration or compensation in kind impossible	Extreme losses affection critical infrastructure or services (e.g., hospital, major industrial complex, major storage facilities for dangerous substances)

**Note 1.** Definitions for population at risk:

**None** – There is no identifiable population at risk, so there is no possibility of loss of life other than through unforeseeable misadventure.

**Temporary**- People are only temporarily in the dam-breach inundation zone (e.g. seasonal cottage use, passing though on transportation routes, participating in recreational activities).

**Permanent**- The population at risk is ordinarily located in the dam-breach inundation zone (e.g., as permanent residents); three consequence classes (high, very high, extreme) are proposed to allow for more detailed estimates of potential loss of life (to assist in decision-making if the appropriate analysis is carried out).

**Note 2.** Definitions for population at risk:

**Unspecified**- The appropriate level of safety required at a dam where people are temporarily at risk depends on the number of people, the exposure time, the nature of their activity, and other conditions. A higher class could be appropriate, depending on the requirements. However, the design flood requirement, for example might not be higher if the temporary population is not likely to be present during the flood season.

The last DSR was carried out by AMECFW in 2015 and based on this review, the CDA Dam Consequence Classification of the North Dam was changed from “Low” to “Significant”. The change was based on an issue raised by AMECFW that there was a potential for liquefaction of the tailings if the dam were to fail and that during a flood event there was a potential for overtopping of the dam. Because of this classification change, the IDF for the North Dam under passive care was changed to 1/3 between the 1,000-year event and the PMF and the design earthquake event was changed from the 1 in 1,000-year event to the 1 in 2,475-year event, respectively (based on passive care guidelines in CDA 2014).

As discussed in Section 5.2, there is no risk of overtopping of the North Dam even in an “extreme worst case” Probable Maximum Precipitation (PMP) event (SRK 2016a) and the recent stability analysis completed by SRK concluded liquefied tailings play no role in dam stability as the critical failure surface runs through the dam, which is constructed of engineered and not the tailings material.

The next DSR is scheduled for 2020.

#### 5.4 Operations, Maintenance and Surveillance (OMS) Manual and Emergency Preparedness and Response Plan (EPRP)

The current OMS Manual and EPRP was prepared by SRK in 2015. The manual and the EPRP were reviewed as part of this 2017 DSI and several changes to both documents are recommended.

In the OMS, the recommendations included changes to the design criteria of the North Dam and the SRS based on the updated dam consequence classification and the frequency of settlement readings for the gauges on the North Dam. In the EPRP, the recommendations included changes to the emergency procedures for the TSF now that the mine has no on-site personnel and no regular surveillance.

It is anticipated that both documents will be updated in the next six months to ensure conformance to Teck’s internal guidelines.

## 6 Summary and Recommendations

### 6.1 Summary

SRK has completed the 2017 DSI of Sä Dena Hes mine TMA and water management infrastructure and concluded that the North Dam, the SRS, the diversion channels and the waste rock dumps are in good condition, and there was no evidence of any dam safety issues or concerns.

Table 6-1 provides a summary of key recommendations from the 2017 dam safety inspection (DSI). There are no outstanding deficiencies or non-conformances from the 2016 or earlier DSI’s.

**Table 6-1: Summary of Deficiencies and Non-Conformances**

Structure	ID No.	Deficiency or Non Conformance	Applicable Regulatory or OMS Reference	Recommended Action	Priority (Teck 2014)	Recommended Deadline/ Status
North Creek Channel	2017-1	Beaver Dam at inlet to channel		Remove beaver dam in channel	3	End of 2017 / Completed July 27 Closed
Pipe Weir at MW-02	2017-2	6-inch pipe has rotated raising ponded water		Reconstruct weir to stabilise	3	End of 2017 / Completed July 27 Closed

**General Description of Priority Rankings<sup>2</sup>**

Priority	Description
1	A high probability or actual dam safety issue considered immediately dangerous to life, health or the environment, or a significant regulatory concern.
2	If not corrected, could likely result in dam safety issues leading to injury, environmental impact or significant regulatory action; or, a repetitive deficiency that demonstrates a systematic breakdown of procedures.
3	Single occurrences of deficiencies or non-conformances that alone would not be expected to result in dam safety issues.
4	Best Management Practice as a suggestion for continuous improvement towards industry best practices that could further reduce potential risks. This typically includes ongoing construction items within the appropriate construction cycle.

**6.2 North Dam**

SRK recommends the following:

- Take piezometric water level readings as per the 2017 water licence.
- To establish trends in dam settlement, annual readings of the settlement gauges on the North Dam should be taken based on the 2012 datum until 2020. This requirement has been updated in the OMS manual.

<sup>2</sup> Based on the Health, Safety and Reclamation Code (HSRC) for Mines in British Columbia (2016 revision).

This final report, 2017 Sä Dena Hes Annual Dam Safety Inspection, was prepared by SRK Consulting (Canada) Inc.

This signature has been scanned.  
The author has given permission for  
its use in this particular document.  
The original signature is held on file.

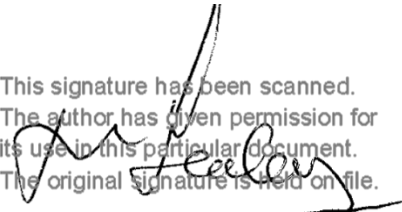

---

Peter Healey, PEng  
Associate

All data used as source material plus the text, tables, figures, and attachments of this document have been reviewed and prepared in accordance with generally accepted professional engineering and environmental practices.

**Disclaimer**—SRK Consulting (Canada) Inc. has prepared this document for Teck Resources Limited. Any use or decisions by which a third party makes of this document are the responsibility of such third parties. In no circumstance does SRK accept any consequential liability arising from commercial decisions or actions resulting from the use of this report by a third party.

The opinions expressed in this report have been based on the information available to SRK at the time of preparation. SRK has exercised all due care in reviewing information supplied by others for use on this project. Whilst SRK has compared key supplied data with expected values, the accuracy of the results and conclusions from the review are entirely reliant on the accuracy and completeness of the supplied data. SRK does not accept responsibility for any errors or omissions in the supplied information, except to the extent that SRK was hired to verify the data.

## 7 References

- Amec Foster Wheeler Environment & Infrastructure, a Division of Amec Foster Wheeler Americas Limited. 2016. Sa Dena Hes Mine, Tailings Management Facility 2051 Dam Safety Review. Report prepared for Teck Resources Limited. TE133102.5000. February 2016.
- Canadian Dam Association (CDA). 2013 Edition. Dam Safety Guidelines 2007
- Canadian Dam Association (CDA). 2014. Technical Bulletin: Application of Dam Safety Guidelines to Mining Dams, April 2014.
- Canadian Dam Association (CDA). 2016. Technical Bulletin Dam Safety Reviews.
- INAC 1992, Mine Site Reclamation Guidelines for Northwest Territories, 1992
- MEMPR (2013), Guidelines for Annual Dam Safety Inspection Reports (August 2013)
- Morton, F.I. 1983. "Operation Estimated of Areal Evapotranspiration and their significance to the science and practice of hydrology." *Journal of Hydrology* 66: 1-76
- SRK Consulting (Canada) Inc., (2015a). 2015 Operation, Maintenance and Surveillance Manual for the Tailings Management Area at Sä Dena Hes Mine. Report prepared for Teck Resources Limited. 1CT008.055. October 2015.
- SRK Consulting (Canada) Inc., (2015b). 2015 Geotechnical Inspection, Tailings Management facility, SDH, YT, November 2015.
- SRK Consulting (Canada) Inc., (2016a). Dam Safety Review Technical Studies, Sä Dena Hes Mine.
- SRK Consulting (Canada) Inc., (2016b). 2016 Dam Safety Inspection, Tailings Management Area SDH, YT, November 2016. Teck Resources Limited (2014). Guidelines for Tailings and Water Retaining Structures, Nov 2014.
- SRK Consulting (Canada) Inc. (2017). Baseline Hydrology at Sä Dena Hes. December 2017.
- Teck Resources Limited, (2014). Guideline for Tailings and Water Retaining Structures, November 2014.
- Yukon Territory Water Board Water License QZ99-045 for SDH mine (YTWB 2002), and its amendments (YTWB 2005 and YTWB 2010)

Figures

---

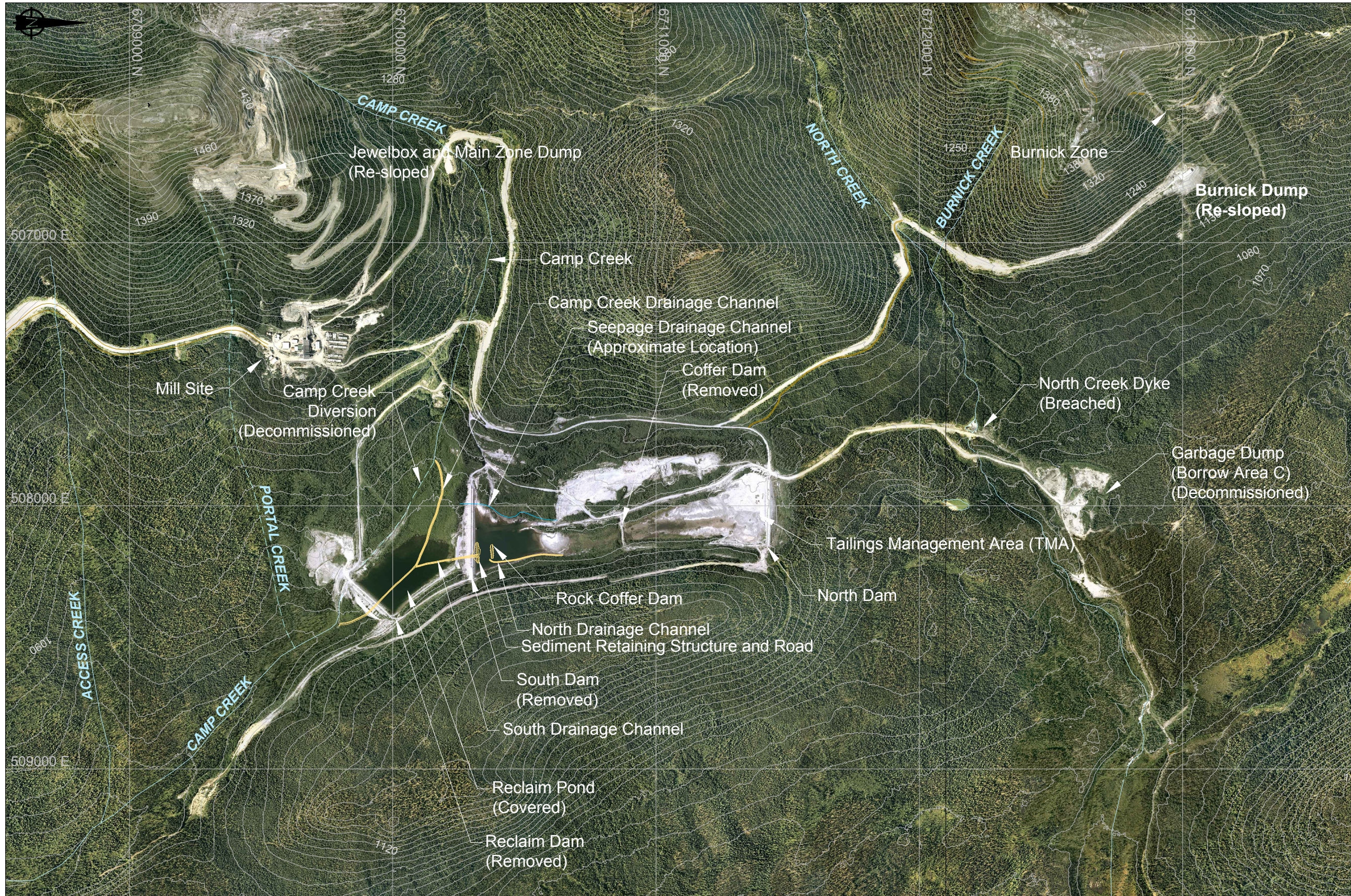

- NOTES**
1. Topographic contour data and aerial photos were obtained from McElhanney and are based on August 15, 2012 LiDAR survey. Coordinate system is UTM NAD 83CSRS zone 9V.
  2. Orthographic photo depicts pre-decommissioned surface.

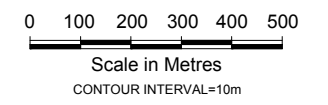

P:\01\_SITES\Sa\_Dena\_Hes\1CT008.065\_2016\_Geotech\_Inspection\040\_AutoCAD\1CT008.065\_Vicinity Map.dwg

		2017 Dam Safety Inspection		
		Vicinity Map		
SRK JOB NO.: 1CT008.065 FILE NAME: 1CT008.065 - Vicinity Map.dwg	Sā Dena Hes Project	DATE: September 2017	APPROVED: PH	FIGURE: 1

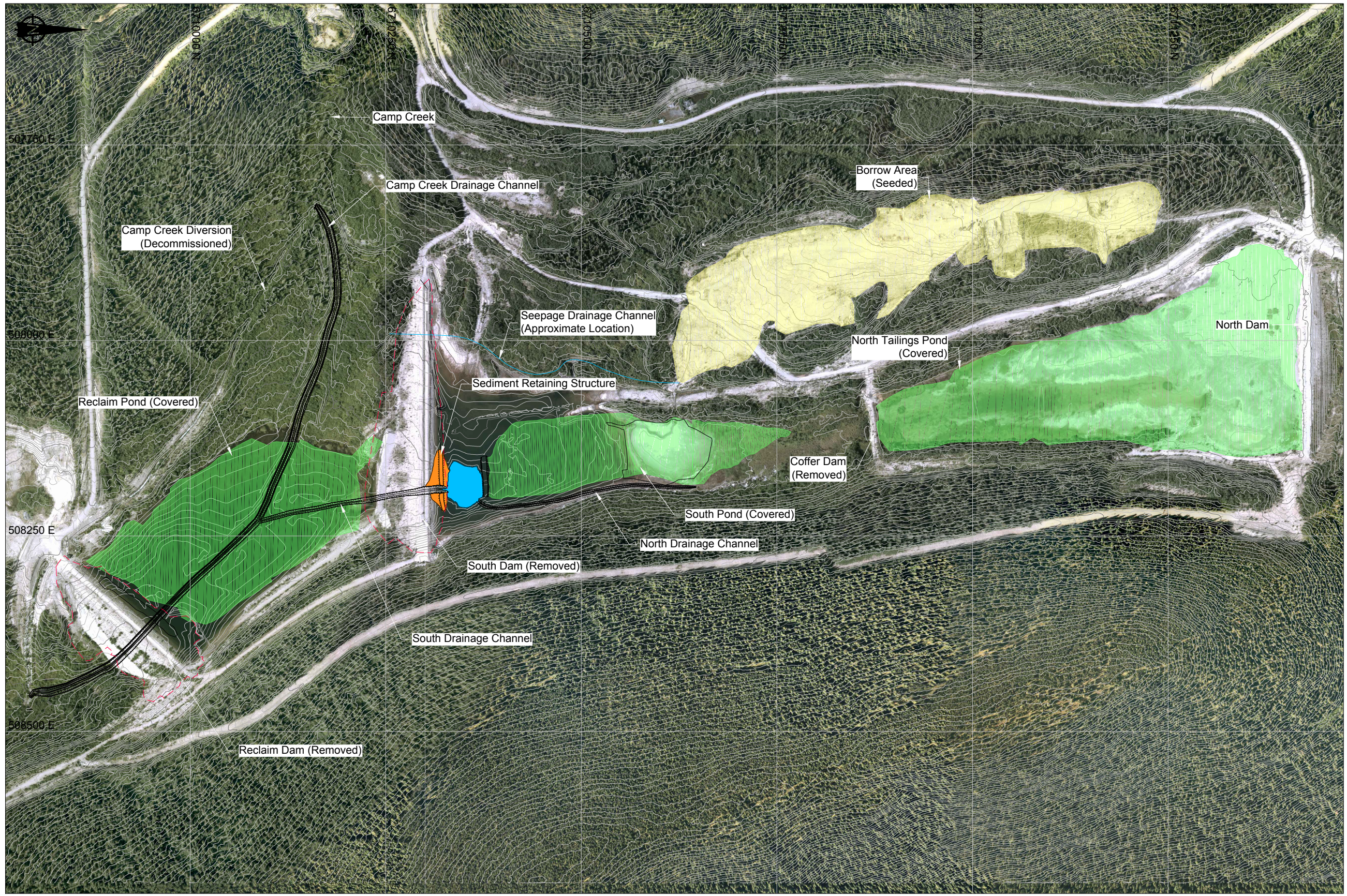

**LEGEND**

- Major Contour (5m interval)
- Minor Contour (1m interval)
- Edge of Road
- Design Edge of Road
- Camp Creek Drainage Channel
- Dam Excavation Extent
- Sedimentation Pond
- Capped Areas
- Seeded Area

- NOTES**
1. Preconstruction topographical contour data was obtained from McElhanney and is based on August 15, 2012 LiDAR Survey.
  2. As-built survey data was collected by Yukon Engineering Services and Amec Foster Wheeler.
  3. Coordinate system is UTM NAD 83 CSRS Zone 9V.
  4. Tailings characterization work conducted by Golder and Associates determined the location of capping at the South Pond and Reclaim Pond areas.

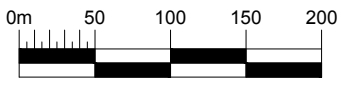

P:\01\_SITES\Sa\_Dena\_Hes\1CT008.065\_2016\_Geotech\_Inspection\040\_AutoCAD\1CT008.065\_General Arrangement.dwg

			2017 Dam Safety Inspection	
	Sà Dena Hes Project		TMA General Arrangement Map	
SRK JOB NO.: 1CT008.065 FILE NAME: 1CT008.065 - General Arrangement.dwg	DATE: September 2017	APPROVED: PMH	FIGURE: 2	

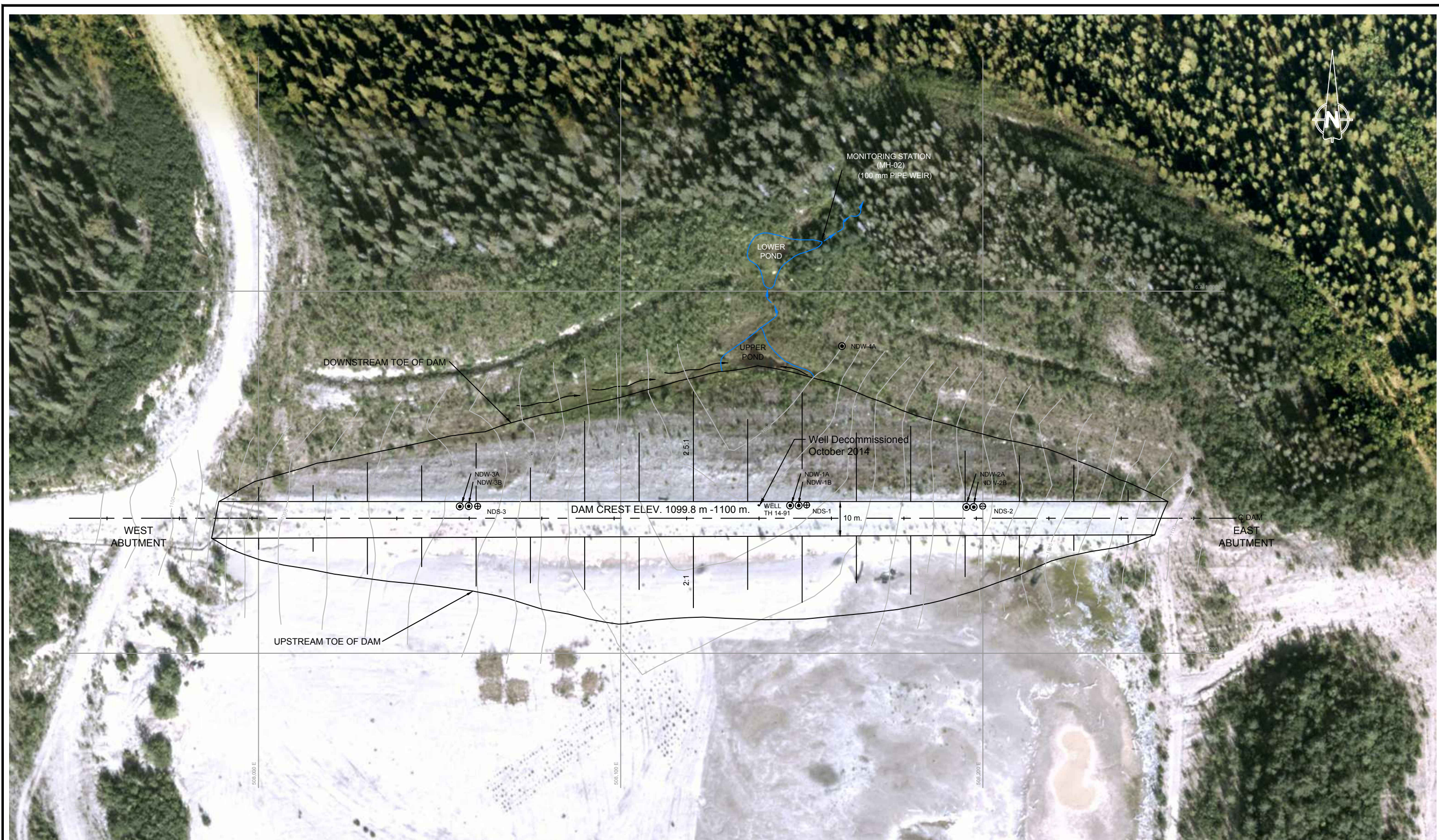

**KEY**

- NDW-1 PIEZOMETERS INSTALLED (NOV., 1991)
- NDS-1 SETTLEMENT GAUGE INSTALLED (NOV., 1991)
- SEEPAGE

**NOTES:**

1. Topographic contour data and aerial photos were obtained from McElhanney and are based on August 15, 2012 LiDAR survey and October 2013 YES Survey. Coordinate system is UTM NAD 83CSRS zone 9V.



SRK JOB NO.: 1CT008.065  
 FILE NAME: 1CT008.065 - North Dam - plan.dwg

Sa Dena Hes Project

2017 Dam Safety Inspection

North Dam  
 Site Plan

DATE: November 2017	APPROVED: P.M.H.	FIGURE: 3
------------------------	---------------------	--------------

P:\01\_SITES\Sa\_Dena\_Hes\1CT008.065\_2016\_Ceotech\_Inspection\040\_AutoCAD\1CT008.065 - North Dam - plan.dwg

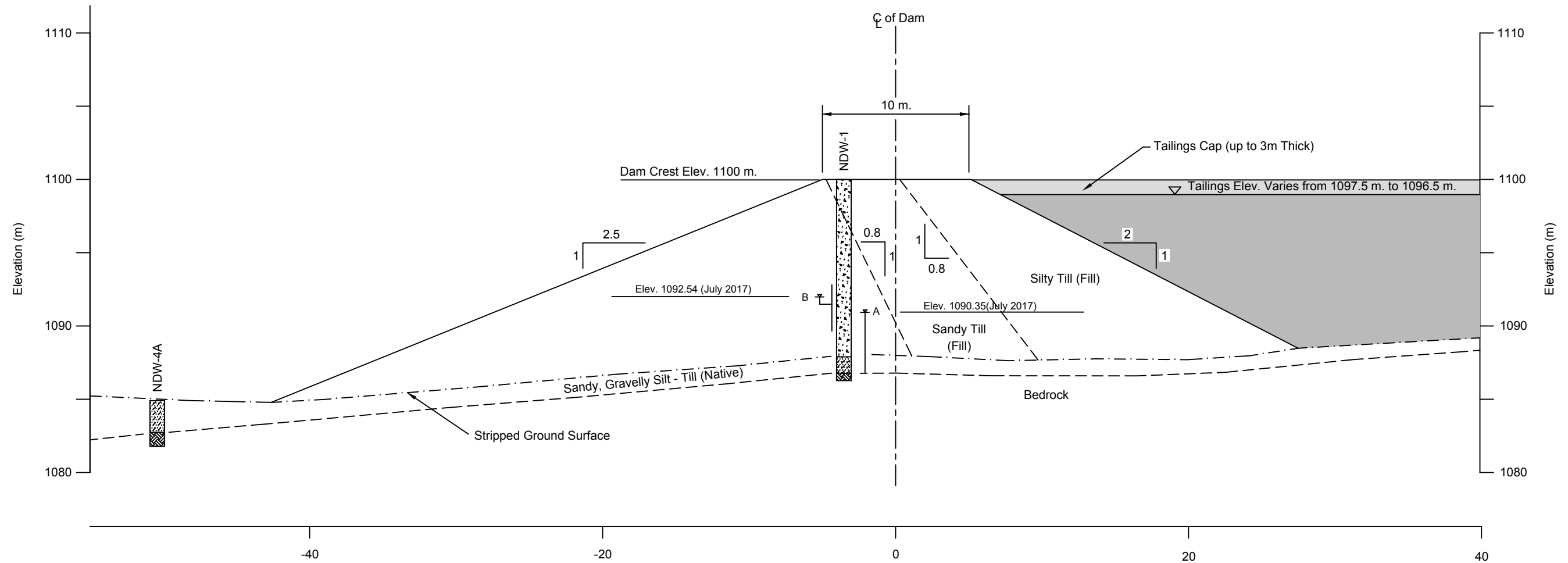

	DATE	T.O.P.	READING	ELEV.
NDW-1B	July 2017	1100.57	8.03	1092.54
NDW-1A	July 2017	1100.69	10.34	1090.35

### LEGEND

	Sandy Till (Fill)		Gravelly Silty Sand (Till)		Tailings
	Silty Till (Fill)		Sand & Gravel (Native)		Tailings Cap
	Sand & Gravel (Fill)		Bedrock		
	Silty Sand (Till)		Piezometric Head for Filter Zone Indicated		

### NOTES





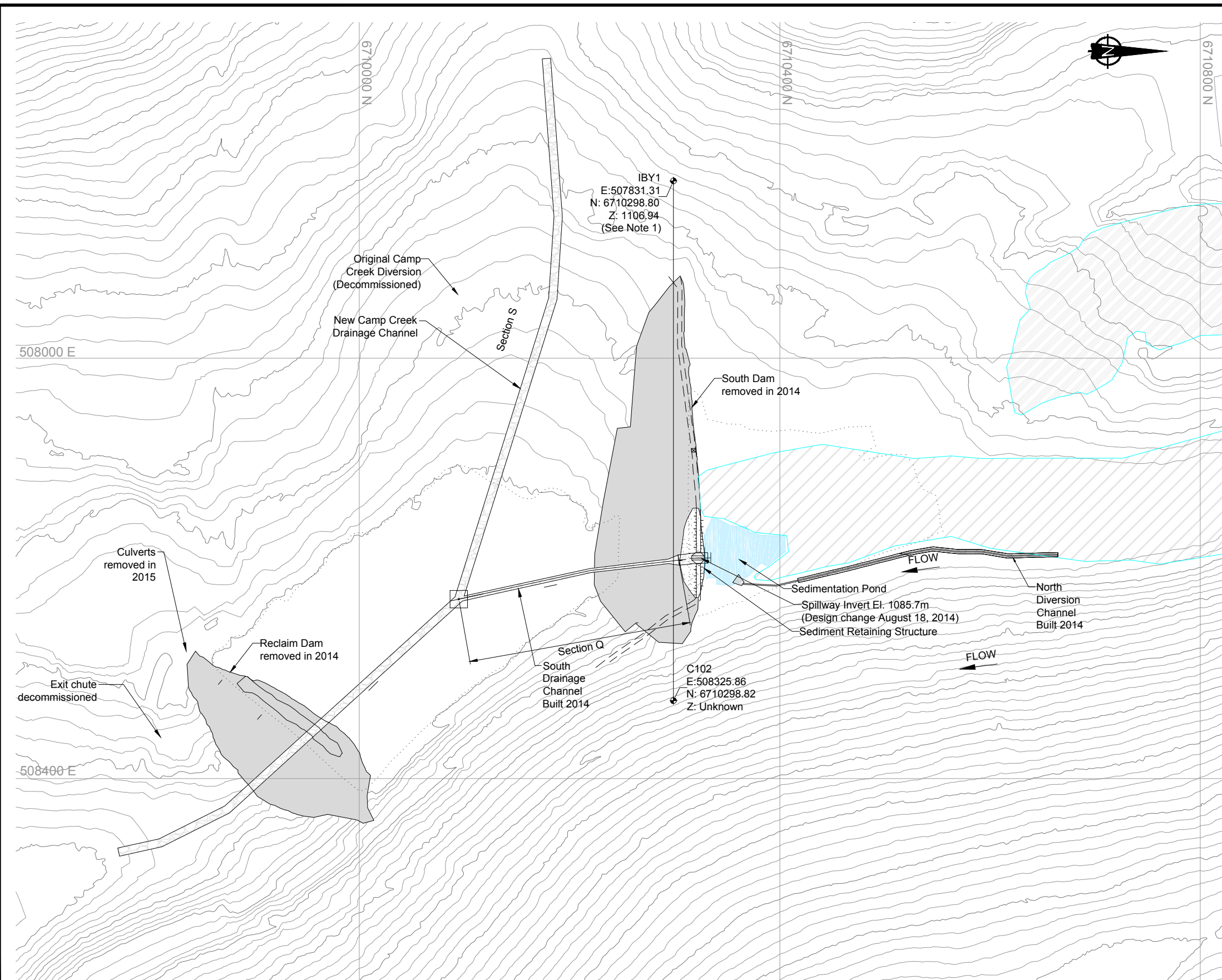

- Topographic contour data and aerial photos were obtained from McElhanney and are based on August 15, 2012 LiDAR survey. Coordinate system is UTM NAD 83CSRS zone 9V.



		2017 Dam Safety Inspection	
		North Dam Section 0+400	
SRK JOB NO.: 1CT008.065	Sä Dena Hes Project	DATE: September 2017	APPROVED: PMH
FILE NAME: 1CT008.065 - North Dam XS.dwg		FIGURE: 4	



**LEGEND**

-  Covered Tailings
-  Removed Dams
-  Sedimentation Pond
-  Minor Contours (1m interval)
-  Major Contours (5m interval)
-  Camp Creek
-  Drainage Channel

**NOTES**

1. This Benchmark datum is currently used to monitor settlement gauges on the dam and was used as the benchmark in construction of the dam. The elevation has been adjusted from 1103.54m to the current LiDAR Survey elevation.

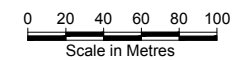

P:\01\_SITES\Sa\_Dena\_Hes\1CT008.057\_2016\_Geotech\_Inspection\040\_AutoCAD\1CT008.057\_TMF.dwg

		2017 Geotechnical Inspection	
		Sediment Retaining Structure Location Map	
SRK JOB NO.: 1CT008.057 FILE NAME: 1CT008.057 - TMF.dwg	Sa Dena Hes Project	DATE: September 2016	APPROVED: PMH
			FIGURE: 5

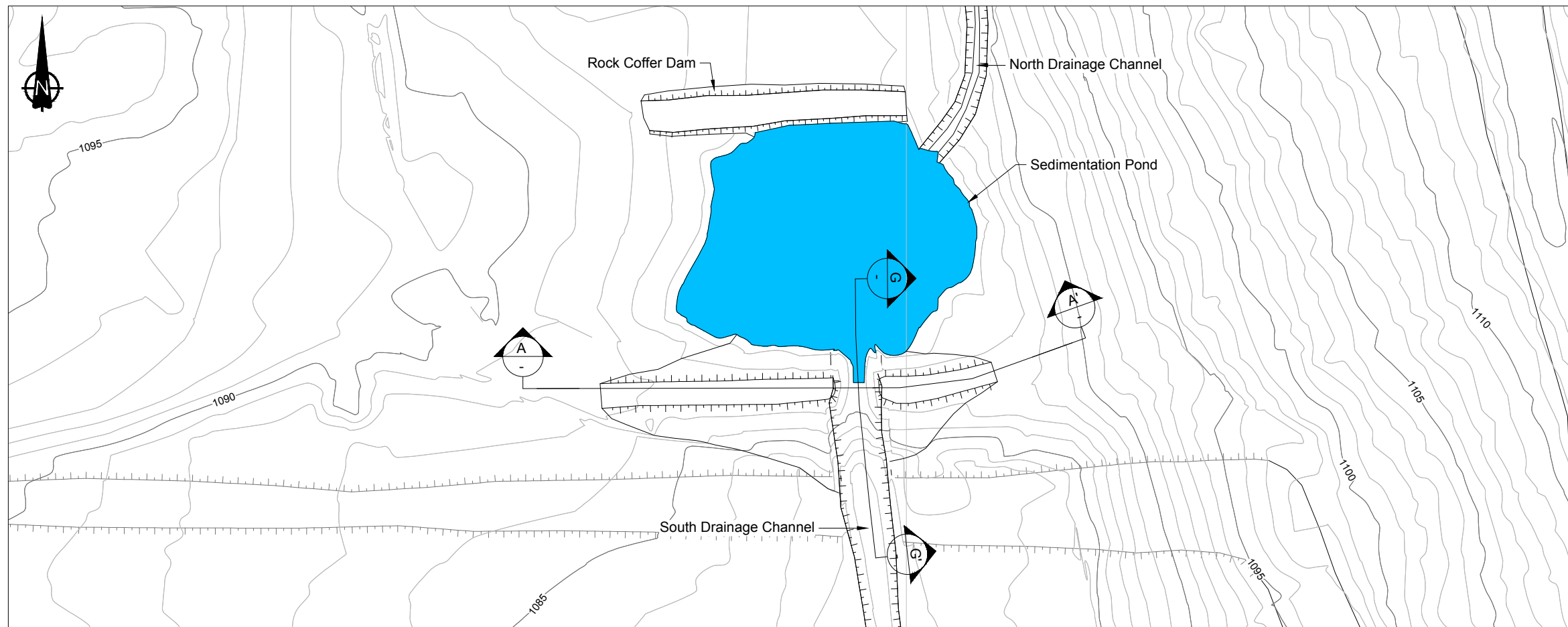

- LEGEND**
- Major Contour (5m)
  - Minor Contour (1m)
  - Dam Crest
  - Dam Toe
  - Edge of Road
  - Sediment Pond
- PROFILE AND DETAIL LEGEND**
- Original Ground
  - Non-woven Geotextile
  - ▨ Riprap

- NOTES**
1. Excavated dam fill material was used to cap tailings. The final excavated surface was graded to promote drainage and blended topography into adjacent natural topography.
  2. Rip rap from downstream toe buttress was salvaged and reused during channel construction.
  3. The decant tower was demolished down to the foundation. Steel reinforced concrete was deposited in the onsite landfill located in Borrow Area C. The remaining concrete foundation was covered with dam fill material and graded to blend into topography.
  4. Design extents of rip rap and geotextile, as no as-built survey.

**Plan**

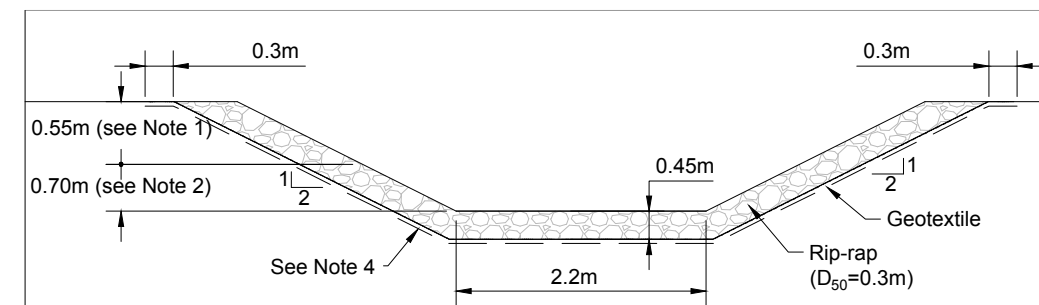
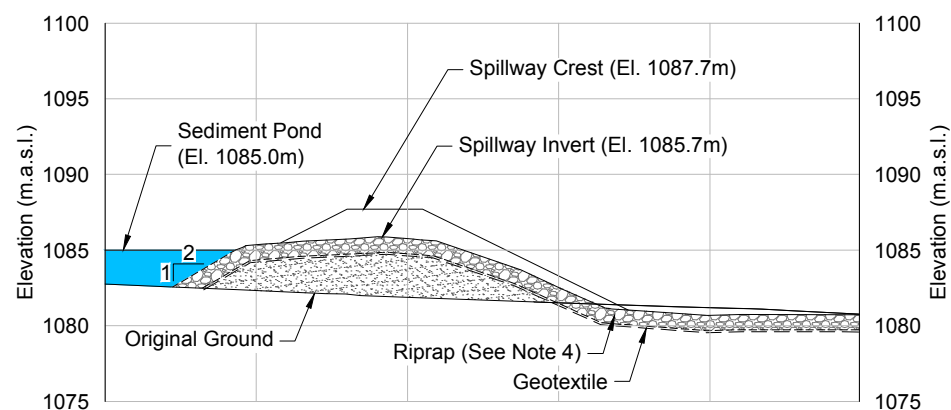
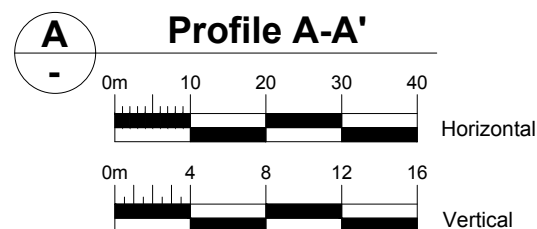
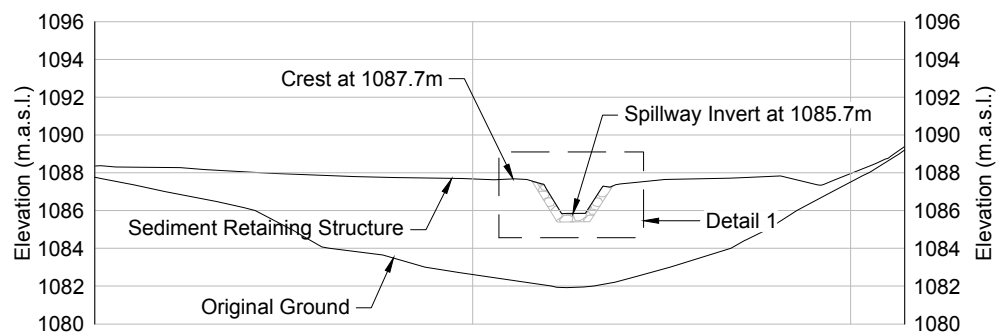

**1**

**Detail 1 - Design Spillway Typical Section**

N.T.S.

		2017 Dam Safety Inspection		
		Sediment Retaining Structure Plan and Profile		
SRK JOB NO.: 1CT008.065 FILE NAME: 1CT008.065 - Sediment Retaining Structure.dwg	Sä Dena Hes Project	DATE: September 2017	APPROVED: PMH	DRAWING: 6

P:\01\_SITES\Sa\_Dena\_Hes\1CT008.065\_2016\_Geotech\_Inspection\040\_AutoCAD\1CT008.065\_SedimentRetainingStructure.dwg

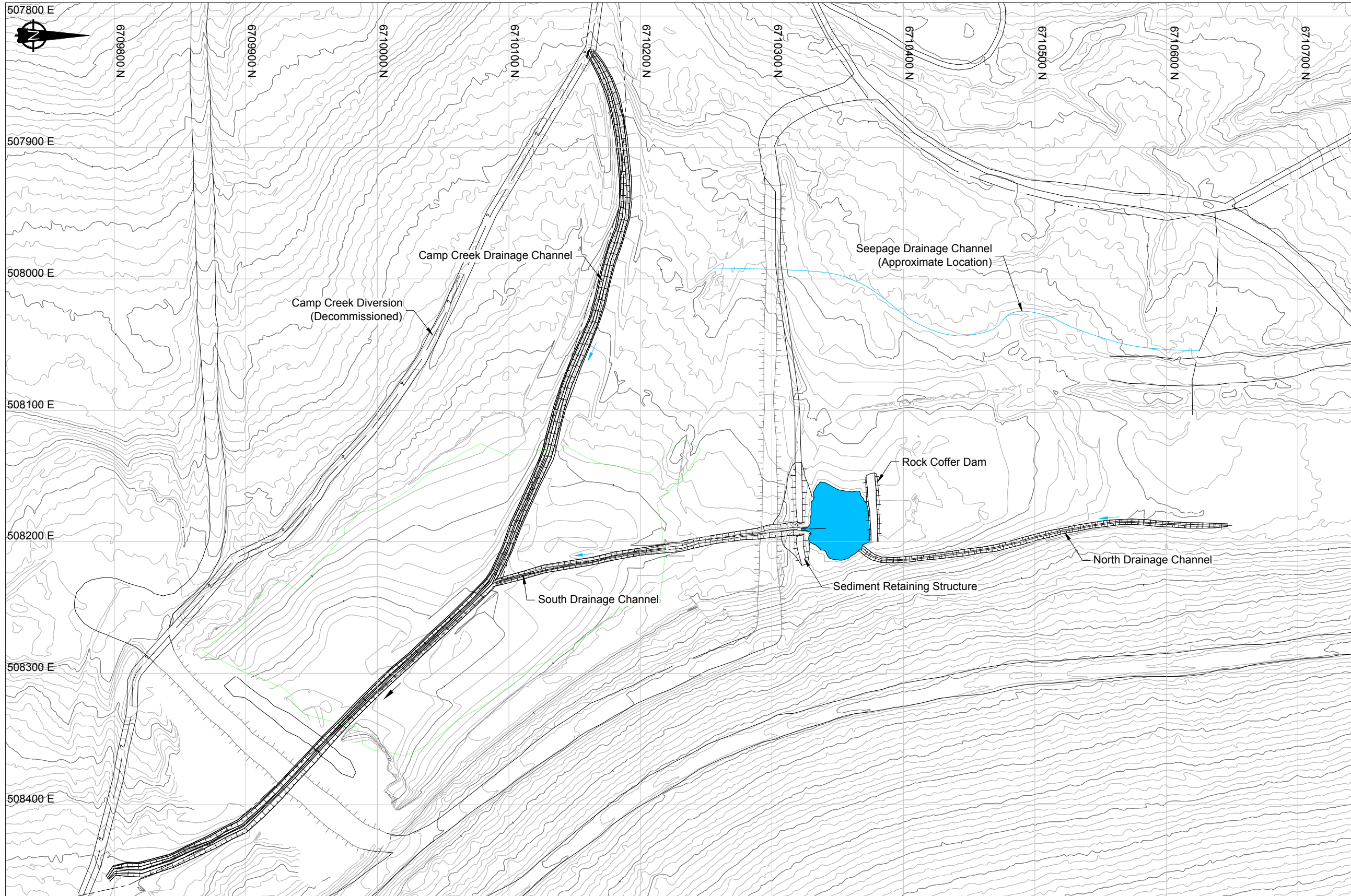

**LEGEND**

	Major Contour (5m)
	Minor Contour (1m)
	Dam Crest
	Dam Toe
	Edge of Road
	Direction of Flow
	Sediment Pond

**NOTES**

- As-built Camp Creek Drainage Channel upstream and downstream tie-in locations and North Drainage Channel alignments were modified from the design by Amec foster wheeler, with consultation from SRK and Teck, based on field conditions.

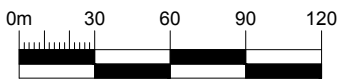

P:\01\_SITES\Sa\_Dena\_Hes\1CT008.065\_2016\_Geotech\_Inspection\040\_AutoCAD\1CT008.065\_Drainage\_Channel.dwg

		2017 Dam Safety Inspection		
		Drainage Channel Plan		
SRK JOB NO.: 1CT008.065 FILE NAME: 1CT008.065 - Drainage Channel.dwg	Sà Dena Hes Project	DATE: September 2017	APPROVED: PMH	DRAWING: 7





**PLAN**  
 0 5 10 15 20 25  
 Scale in Metres

**NOTES**

1. Based on field conditions the North Drainage Channel was realigned to avoid constructing the channel through deposited tailings.
2. Based on field conditions a Rock Cofferdam was constructed to retain soft tailings from sliding into the sediment retention pond during cover construction.
3. The decant tower was demolished down to the foundation. Steel reinforced concrete was deposited in the onsite landfill located in Borrow Area C. The remaining concrete foundation was covered with dam fill material and graded to blend into topography.
4. Design extents of rip rap and geotextile, as no as-built survey.

**LEGEND**

- Major Contours (5m)
- Minor Contours (1m)
- Edge of Road
- Tailings Pipeline
- - - Existing Ground (Profile)
- - - Non-woven Geotextile
- ▨ Covered Tailings (Proposed in Design)
- ▩ Rip Rap
- Sediment Pond (As-built)
- As-built Toe
- As-built Crest
- - - As-built Extent of Excavation / Fill

**Design North Tailings Drainage Channel Riprap Volume Summary Table:**

Location	D <sub>50</sub> (m)	Armoring Depth (m)	Volume (m <sup>3</sup> )
Y	0.3	0.45	638
Discharge Area	0.3	0.45	25

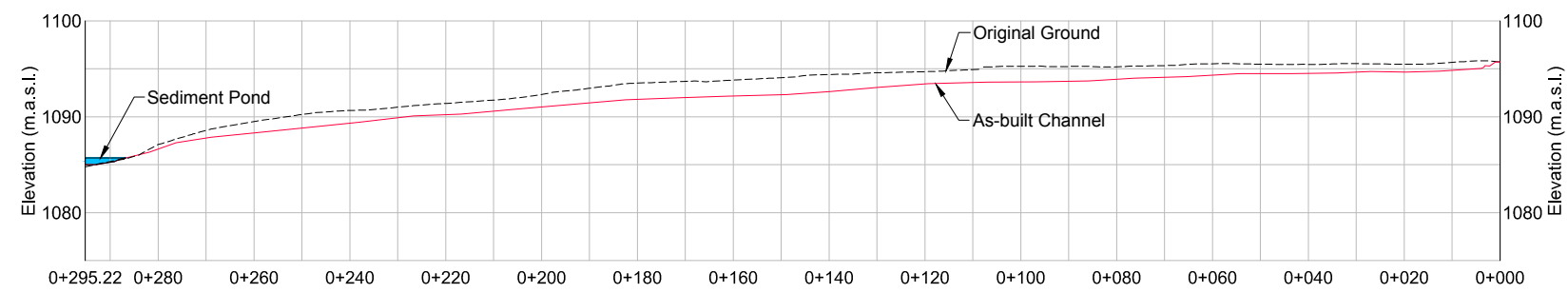
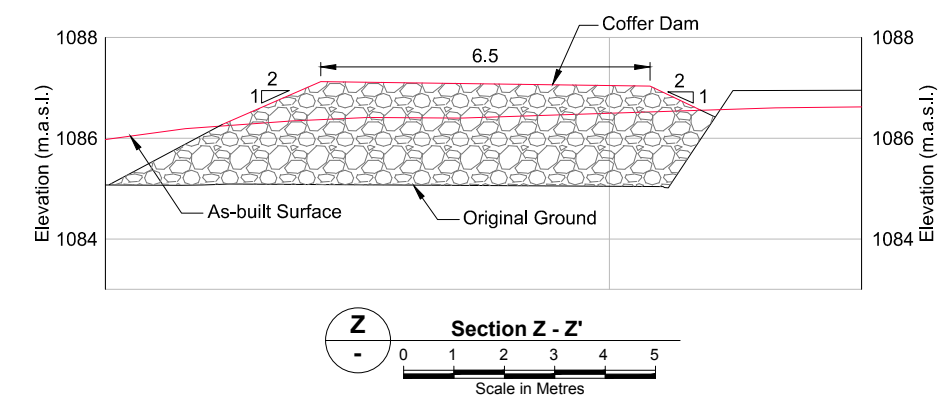

**Profile ND - ND'**  
 2x Vertical Exaggeration  
 Horizontal: 0 5 10 15 20 25  
 Scale in Metres  
 Vertical: 0 2.5 5 7.5 10 12.5  
 Scale in Metres

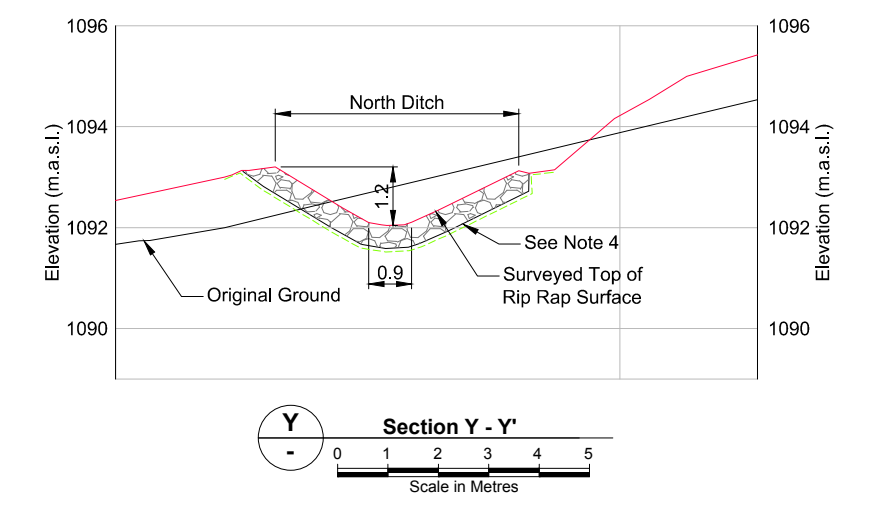

\\uk.adf\hewlett\Projects\101\_SITES\Sa\_Dena\_Hes\1CT008\_065\_2017\_Dam\_Safety\_Inspection\100\_AutoCAD\1CT008065\_SDH-AB\_As-built.dwg

		2017 Dam Safety Inspection		
		DRAWING TITLE: <b>North Drainage Channel Plan, Profile and Section</b>		
SRK JOB NO: 1CT008.065 FILE NAME: 1CT008065_SDH-AB_As-built.dwg	Să Dena Hes Project	DATE: December 2017	APPROVED: PMH	FIGURE NO. <b>9</b>

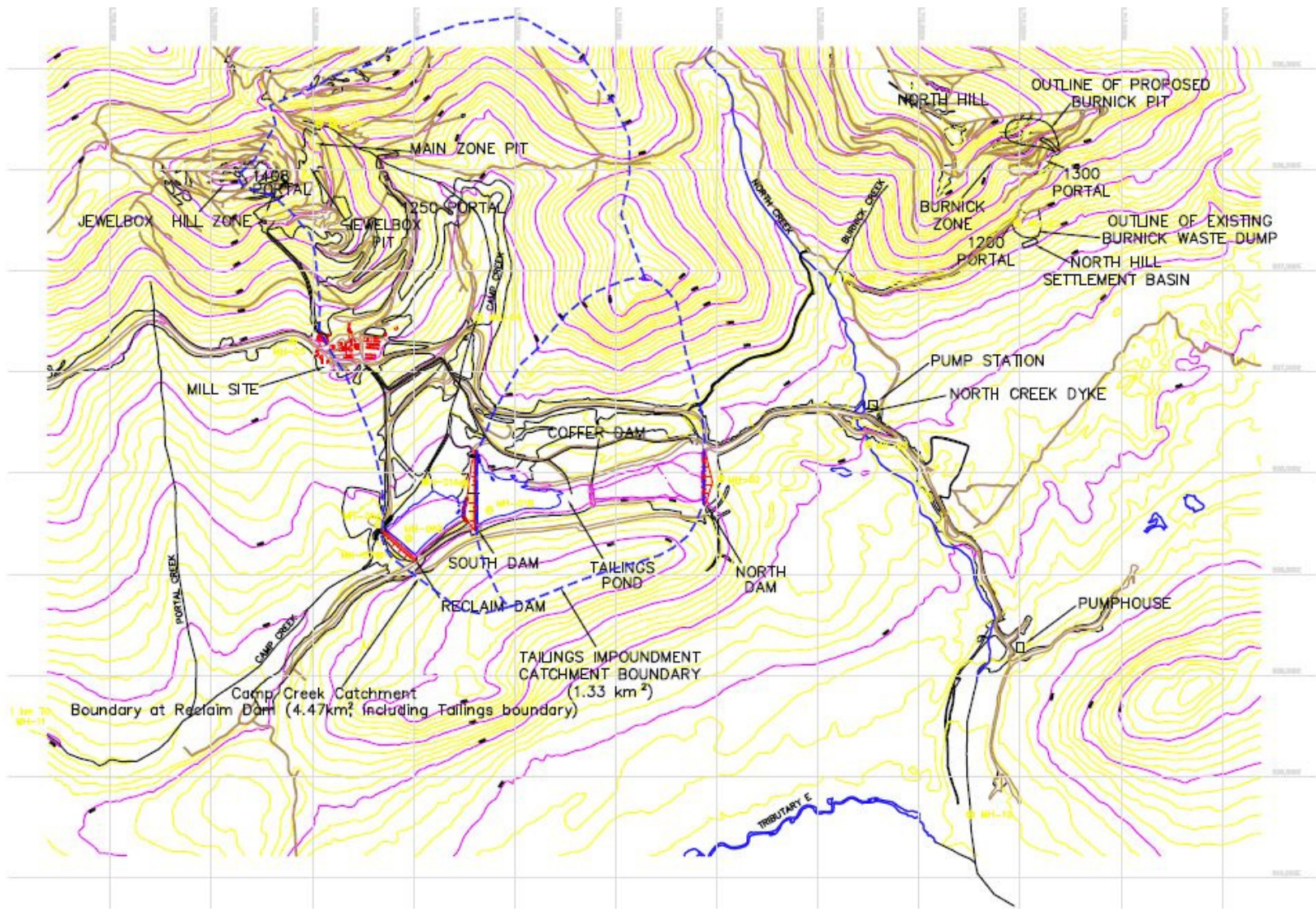

**Teck**

2017 Dam Safety Inspection

**Catchment Areas**

Job No: 1CT008.065  
 Filename: SDH\_CatchmentMap\_sab.ppt

Sä Dena Hes Project

Date:  
 December 2017

Approved:  
 PH

Figure:  
**10**

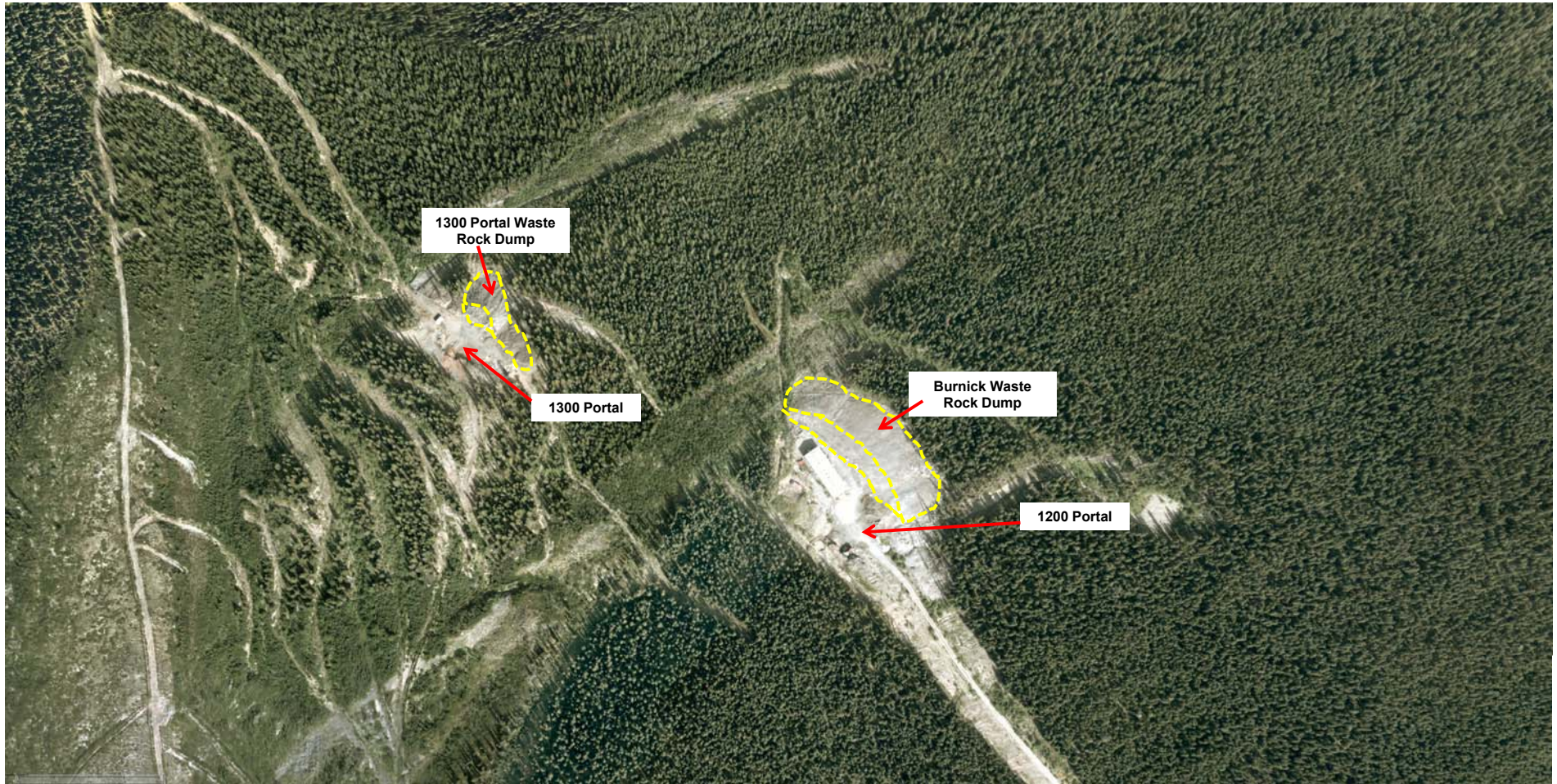

		2017 Dam Safety Inspection		
		Burnick Zone Plan View		
Job No: 1CT008.054 Filename: Burnick Zone.pptx	Sä Dena Hes	Date: December 2017	Approved: PMH	Figure: <b>11</b>

\\wan-srv0.van.na.srk.ad\01\_SITES\Sa\_Dena\_Hes\1CT008\_053\_2015 Geotechnical Investigation\040\_AutoCAD\Powerpoint Figures



		2017 Dam Safety Inspection		
		Main Zone and Jewelbox Zone Plan View		
Job No: 1CT008.054 Filename: Main Zone and Jewelbox Zone.pptx	Sä Dena Hes	Date: December 2017	Approved: PMH	Figure: 12

Appendix A – Photo Log

---



Photo 1: North Dam Crest looking west



Photo 2: Downstream slope of the North Dam. Oversized trees have been removed



Photo 3: North Dam Piezometer at toe NDW 4A



Photo 4: Well cover on NDW 3A



Photo 5: Plastic cap on the Piezometer NDW3A



Photo 6: Hillside Seepage at toe of North Dam



Photo 7: rotated pipe weir at MW 02



Photo 8: Slope Displacement pin on north edge of Dam (redundant)



Photo 9: View looking south of drainage swale on tailings till cover



Photo 10: water in drainage swale draining south



Photo 11: Drainage channel looking north



Photo 12: Beaver dam at inlet to North Creek crossing



Photo 13: North Creek Crossing



Photo 14: Outlet of North Creek crossing



Photo 15: View looking upstream of the North Creek Dyke



Photo 16: Second Crossing of North Creek



Photo 17: View looking west of the SRS and sediment pond



Photo 18: Hillside seepage along D/S toe of dyke



Photo 19: View of the south channel looking south from the SRS Dyke



Photo 20: View looking east of the riprap buttress along the D/S toe of the SRS dyke



Photo 21: Single boil at toe of the SRS dyke



Photo 22: View upstream of the Camp Creek channel



Photo 23: View south of the Camp creek drainage channel



Photo 24: Regraded slopes of Jewelbox waste rock dump



Photo 25: Erosion gullies at toe of Jewelbox Waste rock dump



Photo 26: erosion gullies at toe of Jewelbox waste rock dump



Photo 27 minor subsidence on the slope of the backfill at Portal 1200 on Burnick

Appendix B – Piezometric Levels

---

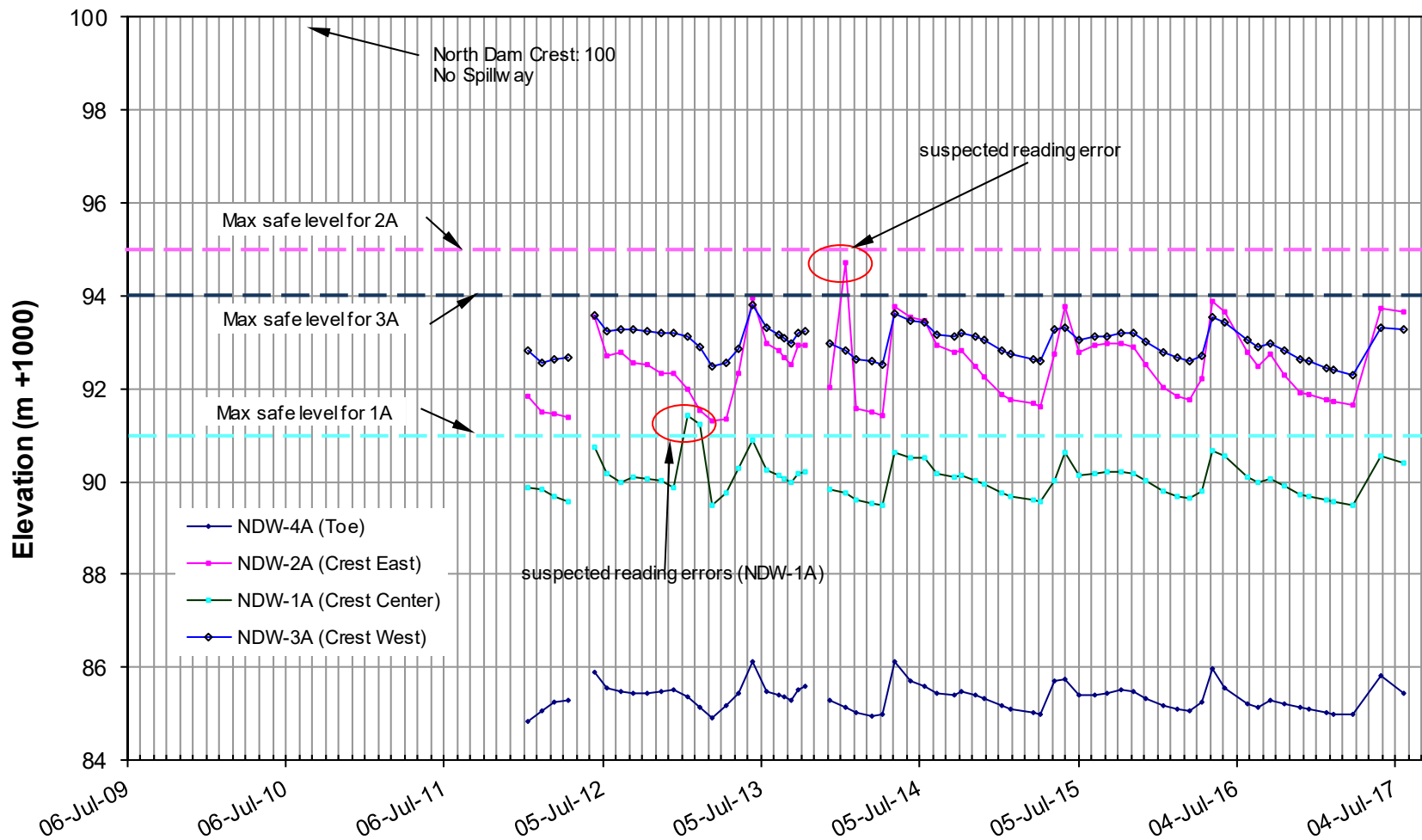

 Job No: 1CT008.065 Filename: FigB2 2017PiezoLevels_1CT008.065_rev1.pptx	 Sa Dená Hes	2017 Dam Safety Inspection		
		<b>2011-2017 Piezometric Levels in North Dam</b>		
		Date: September 2017	Approved: PMH	Figure: <b>B1</b>

**Table B1: Depth to Water from Top of Casing (m)**

Piezo ID	Date of Reading	Date of Reading	Date of Reading	Date of Reading	Date of Reading	Date of Reading	Date of Reading	Date of Reading	Date of Reading
	20-Sep-16	23-Oct-16	28-Nov-16	19-Dec-16	25-Jan-17	12-Feb-17	29-Mar-17	1-Jun-17	23-Jul-17
NDW-1A	10.67	10.84	11.02	11.05	11.15	11.17	11.25	10.18	10.34
NDW-1B	8.02, soft bottom @ 8.04	8.02, soft bottom @ 8.04	8.02, soft bottom @ 8.03	8.03, soft bottom @ 8.04	8.02, soft bottom @ 8.05	8.02, soft bottom @ 8.04	8.02, soft bottom @ 8.04	8.01, soft bottom @ 8.04	8.02, soft bottom @ 8.04
NDW-2A	7.78	8.26	8.61	8.68	8.79	8.82	8.90	6.80	6.88
NDW-2B	5.13, soft bottom @ 5.16	5.14, soft bottom @ 5.17	5.14, soft bottom @ 5.16	5.14, soft bottom @ 5.16	5.14, soft bottom @ 5.16	5.14, soft bottom @ 5.16	5.14, soft bottom @ 5.16	5.14, soft bottom @ 5.16	5.14, soft bottom @ 5.16
NDW-3A	7.59	7.76	7.92	7.98	8.11	8.15	8.29	7.26	7.31
NDW-3B	5.14, soft bottom @ 5.23	5.15, soft bottom @ 5.23	5.15, soft bottom @ 5.23	5.15, soft bottom @ 5.23	5.15, soft bottom @ 5.23	5.15, soft bottom @ 5.23	5.15, soft bottom @ 5.23	5.16, soft bottom @ 5.23	5.15, soft bottom @ 5.23
NDW-4A	3.21	3.29	3.36	3.41	3.48	3.50	3.50, soft bottom @ 3.53	2.66	3.06
TH-14-91	Decommissioned	Decommissioned	Decommissioned	Decommissioned	Decommissioned	Decommissioned	Decommissioned	Decommissioned	Decommissioned

P:\01\_SITES\Sa\_Dena\_Hes\1CT008.065\_2017 Dam Safety Inspection\I080\_Deliverables\1CT008.065\030\_Appendices\Appendix B 1\NDRMPiezolevels\_1CT008 065\_PMH\_20171026.xlsx]20142017PiezoRdgs\_TAB B1