



KENO HILL SILVER DISTRICT MINING OPERATIONS

WASTE ROCK MANAGEMENT PLAN - REVISION 6.5

October 2021

Prepared for:
ALEXCO KENO HILL MINING CORP.

Prepared by:





TABLE OF CONTENTS

1.	KENO HILL SILVER DISTRICT MINING OPERATIONS WASTE ROCK MANAGEMENT	1-1
1.1	INTRODUCTION	1-1
1.2	PURPOSE OF PLAN	1-1
1.3	SCOPE OF PLAN.....	1-2
2.	MINE LOCATION AND DESCRIPTION.....	2-1
2.1	LOCATION SITE.....	2-1
2.2	SURFACE WASTE ROCK FACILITY DESIGN	2-6
2.2.1	N-AML Waste Rock Disposal Areas	2-6
2.2.2	P-AML Waste Rock Storage Facilities.....	2-6
2.2.3	Waste Rock Handling	2-7
3.	ROCK CHARACTERIZATION	3-1
3.1	SUMMARY OF ROCK CHARACTERIZATION.....	3-1
3.2	SUMMARY OF FLAME & MOTH WASTE ROCK CHARACTERIZATION	3-3
3.3	SUMMARY OF BIRMINGHAM WASTE ROCK CHARACTERIZATION	3-4
3.4	WASTE ROCK CATEGORIES	3-5
3.5	RESULTS FROM GEOCHEMICAL STUDIES APPLIED TO ROCK CHARACTERIZATION.....	3-6
3.5.1	P-AML Waste Rock Geochemical Screening Criteria from Analytical Data	3-6
3.5.2	Estimated Proportions of P-AML and N-AML Rock.....	3-8
4.	ROCK MANAGEMENT	4-1
4.1	WASTE ROCK SCREENING	4-1
4.2	P-AML FIELD CRITERIA	4-1
4.3	FACE SAMPLING	4-1
4.4	ONSITE LABORATORY TESTING.....	4-5
4.5	WASTE ROCK CLASSIFICATION BASED ON FIELD SCREENING.....	4-6
4.6	CONFIRMATORY SAMPLING AND TESTING.....	4-6
4.7	TIME LAG.....	4-8
4.7.1	Time Lag between Excavation and Sampling.....	4-8
4.7.2	Time Lag between Excavation and Receipt of Analytical Data	4-8
4.7.3	Time Lag between Excavation and Receipt of ICP Data.....	4-8
4.7.4	Time Lag between Excavation and Receipt of ABA Data	4-8
4.8	GEOCHEMICAL SCREENING CRITERIA.....	4-8
5.	WASTE ROCK MONITORING	5-1
5.1	PHYSICAL INSPECTION METHODS	5-1
5.2	WASTE ROCK CLASSIFICATION RECORD	5-2



5.3	KINETIC TESTING OF WASTE ROCK.....	5-2
5.3.1	Kinetic Testing of N-AML Waste Rock.....	5-3
5.3.2	Kinetic Testing of P-AML Waste Rock	5-3
5.3.3	Saturated Column Testing of Backfill Material	5-4
5.4	USE OF N-AML ROCK FOR CONSTRUCTION PURPOSES	5-4
5.4.1	Flame & Moth	5-4
5.4.2	Birmingham.....	5-4
6.	ADAPTIVE MANAGEMENT.....	6-1
7.	REPORTING	7-1
8.	CLOSURE AND RECLAMATION.....	8-1
9.	REFERENCES.....	9-1

LIST OF TABLES

Table 2-1:	Waste Rock Storage Facilities	2-6
Table 2-2:	Waste Rock Handling by Mine.....	2-8
Table 3-1:	Waste Rock Categories and Management.....	3-6
Table 3-2:	Proportion of Samples Filtered as P-AML in Bellekeno Waste Rock Drillhole Database	3-8
Table 3-3:	Proportion of Samples Filtered as P-AML in Flame & Moth Area of Proposed Excavation.....	3-8
Table 3-4:	Proportion of Samples Filtered as P-AML in Birmingham Area of Proposed Excavation	3-8
Table 4-1:	Number of Blast Rounds for a 3x3 m Workings to Meet Confirmatory Sampling Threshold	4-6
Table 4-2:	Waste Rock Classification Criteria	4-9
Table 5-1:	Physical Inspection Rating System.....	5-2

LIST OF FIGURES

Figure 2-1:	Project Location	2-2
Figure 2-2:	Bellekeno Mine Layout	2-3
Figure 2-3:	District Mill and Flame & Moth Layout.....	2-4
Figure 2-4:	Birmingham Mine Layout	2-5
Figure 2-5:	Birmingham N-AML WRDA Design	2-9



Figure 2-6: Bellekeno East P-AML Site Plan 2-10

Figure 2-7: Bellekeno East P-AML Profile, Cross Section and Detail..... 2-11

Figure 2-8: Flame & Moth P-AML As-Built Site Plan 2-12

Figure 2-9: Birmingham P-AML As-built Site Plan..... 2-13

Figure 3-1: Keno Hill Development Waste Rock Characterization Studies – Components and Key Results 3-2

Figure 3-2: Keno Hill Development N-AML Categorization 3-6

Figure 4-1: Face Sampling Method 4-3

Figure 4-2: Example of Face Sampling Form..... 4-5

Figure 4-3: Face Photo of Bellekeno 625 Bypass Showing Sampling According to Lithology and Calculated Sample Areas..... 4-7

APPENDICES

- Appendix A: AKHM Waste Rock ARD/ML Characterization Update 5 – September 2021
- Appendix B: Review of Net Acid Generation and Metal Leaching Controlling and Correlating Factors - Keno Hill Silver District
- Appendix C: Typical Waste Containment Facility Design, Keno Hill Silver District, YT, Construction Specifications, Issued for Use

1. KENO HILL SILVER DISTRICT MINING OPERATIONS WASTE ROCK MANAGEMENT

1.1 INTRODUCTION

The Bellekeno Advanced Underground Exploration and Development Program, assessed under YESAB project number 2008-0039, presented a comprehensive Waste Rock Management Plan (WRMP) for the estimated 248,000 tonnes of waste rock to be excavated over 5 years. The Bellekeno Waste Rock Management Plan was based on studies by Altura Environmental Consulting (Altura). These studies described the Acid Rock Drainage/Metal Leachate (ARD/ML) controlling and correlating factors that are common across the district (Altura, 2008a) as well as the specific geo-environmental characterization of the Bellekeno Zone (Altura, 2008b).

Since the Bellekeno WRMP was developed, permitting and licencing of the Flame & Moth and Bermingham deposits has been completed. Clause 9.10 of QML-0009 and Clause 21 of Water Licence QZ18-044 outline the maximum quantities waste rock that are to be removed from the Bellekeno, Flame & Moth, and Bermingham workings during the undertaking. To use the Waste Rock Management Plan for Flame & Moth and Bermingham, geochemical characterization studies of the Flame & Moth deposit (AEG, 2016) and Bermingham deposit (AEG, 2019a) were completed. The results are summarised in Appendix A and included in updates to this management plan.

1.2 PURPOSE OF PLAN

This plan outlines practices for management of waste rock to be excavated from the Bellekeno, Flame & Moth, and Bermingham deposits as required under Clause 43 of Water Licence QZ18-044.

43. Within 90 days of the effective date of this Licence, the Licensee must submit to the Board an update to exhibit 1.5.3, WRMP. The updated plan must include:
- a) updated results of testing completed to-date and plans for further kinetic testing of N-AML and P-AML Waste Rock for New Bermingham, Bellekeno, and Flame and Moth Mines;
 - b) the plan for saturated column testing for backfill material for New Bermingham, Bellekeno, and Flame and Moth Mines. The material selected for the saturated columns should be representative of the backfill at each site, which may include P-AML and N-AML waste rock, tailings, and cement;
 - c) kinetic testing for brine cements, if brines are produced by water treatment plants; and
 - d) storage facilities required for waste rock amounts permitted under Clause 21 of this Licence.

The plan is intended to ensure that appropriate management procedures are followed in order to minimize potential impacts of waste rock brought to surface on land and water resources. Monitoring following waste rock management activities is intended to assess the effectiveness of the management measures, ensure that adaptive management approaches are implemented and that appropriate information is obtained by Alexco to assist in closure planning.



1.3 SCOPE OF PLAN

Aspects included in this plan are:

- Definition of rock categories based on potential for reactivity (specifically, acid generation and/or metal leaching);
- Estimation of quantities of each category to be excavated to surface during mining operations;
- Operational categorization of excavated rock;
- Geochemical confirmatory testing including acid-base accounting (ABA) and elemental analysis;
- Control measures as required to mitigate effects of potential acid generation and/or metal leaching;
- Monitoring and physical inspection activities for waste rock storage areas;
- Reporting of waste rock management activities;
- Geotechnical design of waste rock storage areas; and
- Kinetic testing of waste rock designated as potentially acid generating and/or metal leaching (P-AML) and non-acid generating and/or metal leaching (N-AML).

2. MINE LOCATION AND DESCRIPTION

2.1 LOCATION SITE

The Keno Hill Silver District is located in central Yukon Territory, 354 km (by air) due north of Whitehorse. The project location is shown in Figure 2-1.

The Bellekeno mine area is located approximately 3 km east of Keno City within the Keno Hill Silver District (Figure 2-2). The Flame & Moth mine, District Mill site and Dry Stack Tailings Facility (hereinafter referred to as the "DSTF") are located approximately 1 km west of Keno City (Figure 2-3). The Birmingham deposit is located on northwest slope of Galena Hill ~6.8 km east of Keno City in the No Cash Bog catchment (Figure 2-4).

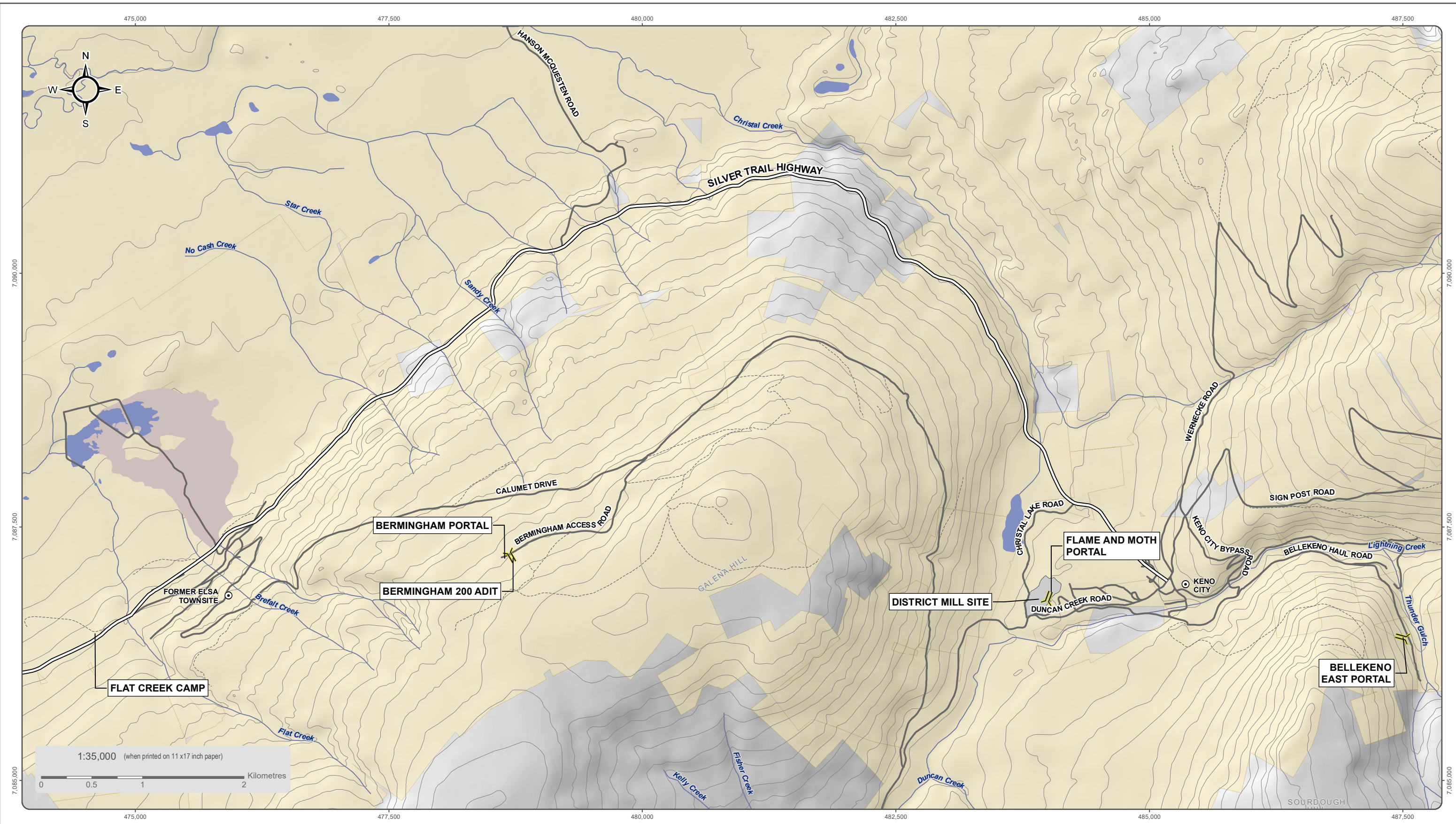

National Topographic Data Base (NTDB) compiled by Natural Resources Canada at a scale of 1:50,000. Cadastral data compiled by Natural Resources Canada. Reproduced under license from Her Majesty the Queen in Right of Canada, Department of Natural Resources Canada. All rights reserved.

Satellite imagery obtained from Yukon Geomatics map service <http://mapservices.gov.yk.ca/ArcGIS/services> on September 2020

Datum: NAD 83; Map Projection: UTM Zone 8N

This drawing has been prepared for the use of Ensero Solution's client and may not be used, reproduced or relied upon by third parties, except as agreed by Ensero Solutions and its client, as required by law or for use of governmental reviewing agencies. Ensero Solutions accepts no responsibility, and denies any liability whatsoever, to any party that modifies this drawing without Ensero Solutions express written consent

<ul style="list-style-type: none"> Place of Interest Adit Alexco/ERDC Quartz Claims 	<ul style="list-style-type: none"> Tailings Area Waterbody Watercourse 	<ul style="list-style-type: none"> Silver Trail Highway Road Limited-Use Road
---	--	---



ALEXCO KENO HILL MINING CORP.

FIGURE 2-1
KENO HILL SILVER DISTRICT
MINING OPERATIONS OVERVIEW

OCTOBER 2020

D:\Project\AI\Project\ALEX-05-01\gis\mxd\Overview_Map\Property_Overview\New_Mines_20200903.mxd
(Last edited by: amalsheska.2020-09-03 15:24 PM)



Adit

As Built Mine Feature

Pond

Underground Workings

Haul Road

Watercourse



ALEXCO KENO HILL MINING CORP.

**FIGURE 2-2
BELLEKENO MINE OVERVIEW**

OCTOBER 2020

Satellite imagery obtained from ESRI ArcGIS map service <https://services.arcgisonline.com/ArcGIS/rest/service> on October 21 2020.

Datum: NAD 83; Projection: UTM Zone 8N

This drawing has been prepared for the use of Ensero Solution's client and may not be used, reproduced or relied upon by third parties, except as agreed by Ensero Solutions and its client, as required by law or for use of governmental reviewing agencies. Ensero Solutions accepts no responsibility, and denies any liability whatsoever, to any party that modifies this drawing without Ensero Solutions express written consent

D:\Project\AllProjects\Keno_Area_Mines\Bellekeno\GIS\mxd\Overview_Maps\Overviews\Mine Site\BK_Overview_2021021.mxd
(Last edited by: amattashevska, 2020-10-21/12:13 PM)

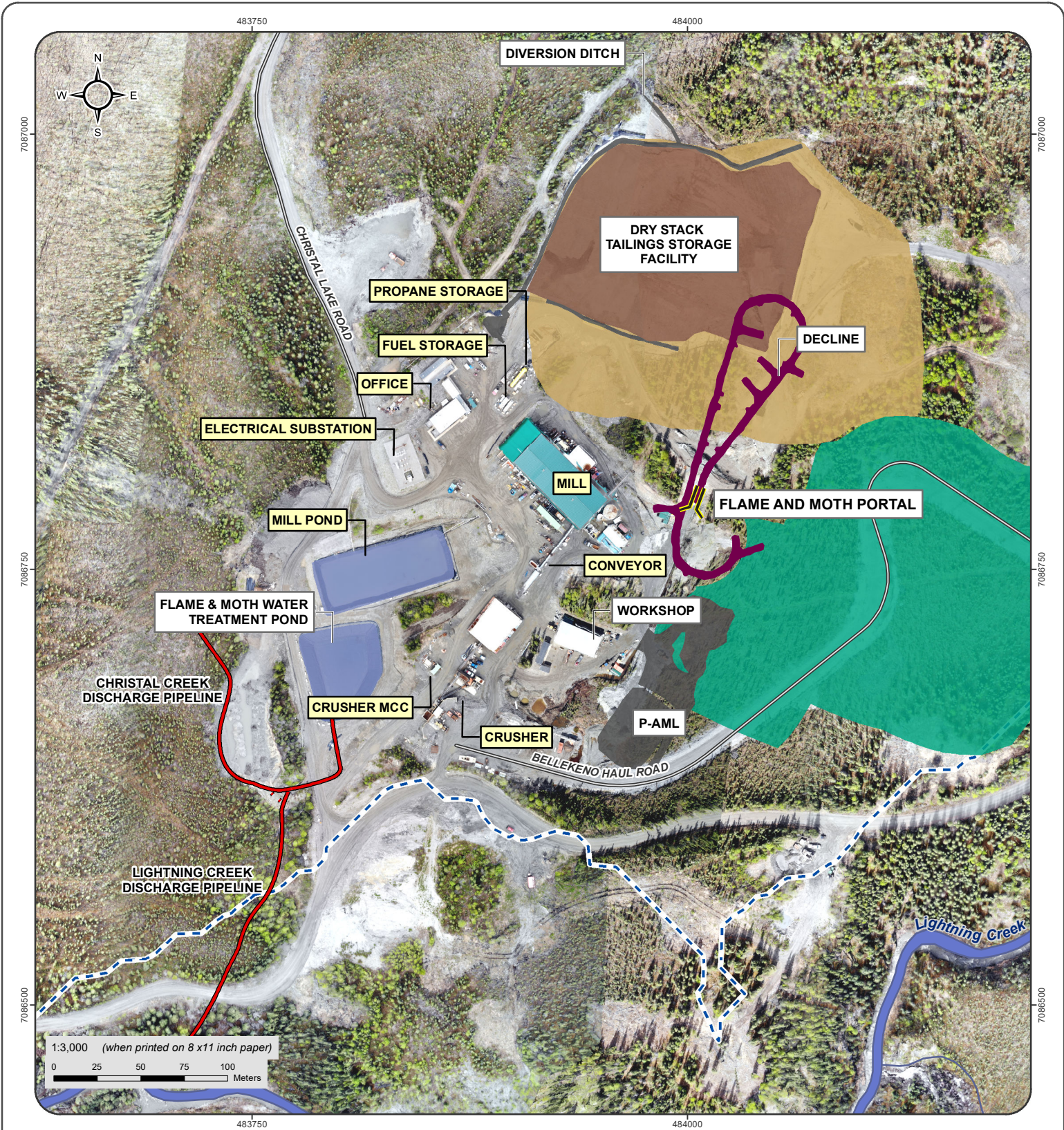

- | | | |
|--------------------------------|---------------|-------------------------------------|
| Flame and Moth Portal Features | Adit | Infrastructure Footprint |
| District Mill Features | Decline | Pond |
| | Pipeline | DSTF 322k Tonnes Design |
| | Catchment | Current DSTF |
| | Contours 5 m) | Peritted To Be Constructed Features |



ALEXCO KENO HILL MINING CORP.

**FIGURE 2-3
FLAME AND MOTH, MILL AND DSTF
LAYOUT OVERVIEW**

OCTOBER 2020



Satellite imagery obtained from Yukon Geomatics map service <http://mapservices.gov.yk.ca/ArcGIS/services> on October 2020

Datum: NAD 83; Projection: UTM Zone 8N

This drawing has been prepared for the use of Ensero Solution's client and may not be used, reproduced or relied upon by third parties, except as agreed by Ensero Solutions and its client, as required by law or for use of governmental reviewing agencies. Ensero Solutions accepts no responsibility, and denies any liability whatsoever, to any party that modifies this drawing without Ensero Solutions express written consent

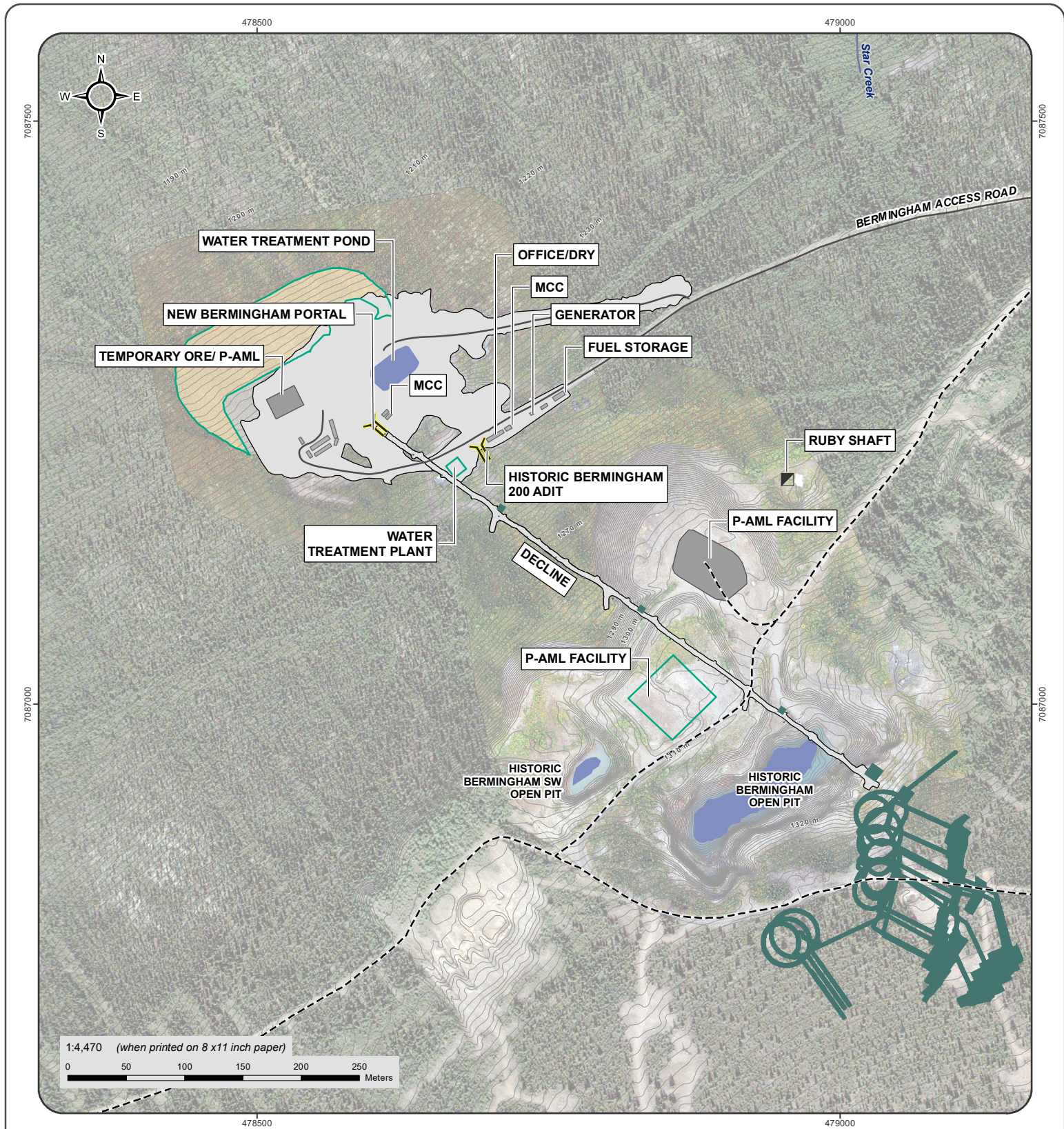
D:\Project\AllProjects\Keno_Area_Mines\ALL_SITES\02-Map\01_Overview\02-District Mill\District_Mill_vs_FM_Features_20201023.mxd
(Last edited by: amatlashevskia; 2020-10-23/08:59 AM)



- | | | | |
|---|-------------------------------|---|---|
|  | Adit/Portal |  | Permitted To Be Constructed Mine Features |
|  | Shaft |  | Waterbody |
|  | Proposed Underground Workings |  | Road |
|  | As Built Mine Footprint |  | Limited-Use Road |
| | |  | Contour (1m interval) |

Satellite imagery obtained from ESRI ArcGIS map service <https://services.arcgisonline.com/ArcGIS/rest/service> on October 21 2020.
 Datum: NAD 83; Projection: UTM Zone 8N

This drawing has been prepared for the use of Ensero Solution's client and may not be used, reproduced or relied upon by third parties, except as agreed by Ensero Solutions and its client, as required by law or for use of governmental reviewing agencies. Ensero Solutions accepts no responsibility, and denies any liability whatsoever, to any party that modifies this drawing without Ensero Solutions express written consent



ALEXCO KENO HILL MINING CORP.

FIGURE 2-4
BIRMINGHAM MINE PROJECT LAYOUT

OCTOBER 2020

D:\Project\AllProjects\Keno_Area_Mines\BERM\Maps\01-Overview\03-Overview\CloseUp\Berm_Overview_Layout_20201021.mxd
 (Last edited by: amattashevskis, 2020-10-21/16:31 PM)

2.2 SURFACE WASTE ROCK FACILITY DESIGN

Waste rock from Bellekeno, Flame & Moth, and Birmingham mines will be deposited at waste storage facilities with permitted tonnage listed in Table 2-1.

Table 2-1: Waste Rock Storage Facilities

Mine Site	Waste Rock Type	Maximum Amount (tonnes)	Disposal Location
Bellekeno	P-AML	2,073	Bellekeno P-AML Waste Rock Storage Facility
Flame & Moth	P-AML	12,000	Flame & Moth P-AML Waste Rock Storage Facility
Flame & Moth	N-AML	125,000	Keno Hill Silver District Mill Site
New Birmingham	P-AML	16,000	New Birmingham P-AML Waste Rock Storage Facility
New Birmingham	N-AML	190,000	New Birmingham N-AML Waste Rock Storage Facility

2.2.1 N-AML WASTE ROCK DISPOSAL AREAS

To date, Alexco has utilized all N-AML waste rock produced from any of its operations and underground development within the District for site construction purposes (e.g., Bellekeno road construction, laydown areas, general construction of site infrastructure). Therefore, to date, no dedicated N-AML WRDAs have been constructed in the District.

A N-AML waste rock disposal area (WRDA) will be constructed at Birmingham. The new Birmingham portal area will be extended to the north to accommodate N-AML material from the Birmingham mine not used as underground mine backfill or for surface construction (Figure 2-4). The issued for construction design for the Birmingham N-AML WRDA that was submitted to Yukon Government in July 2021 is presented in Figure 2-5 and construction has started. The Flame & Moth N-AML waste rock will be used as construction material around the District mill site or as backfill underground.

2.2.2 P-AML WASTE ROCK STORAGE FACILITIES

Surface storage of P-AML waste rock within Waste Rock Storage Facilities (WRSF) was proposed for the Bellekeno, Flame & Moth, and Birmingham. Alexco relies on an approved EBA design entitled *Typical Waste Containment Facility Design, Keno Hill Silver District, YT* (EBA, 2008) for temporary surface storage of P-AML waste rock within the Keno Hill District, which forms Appendix C. Prior to construction of new P-AML Waste Rock Storage Facilities (WRSFs), Alexco will submit Issued for Use designs for review and approval prior to construction as required by the Water Licence and Quartz Mining License.

The Bellekeno temporary P-AML WRSF (Figure 2-2) is the only P-AML WRSF built to date. The site plan, profile, cross section and detail of the proposed Bellekeno P-AML WRSF are shown in Figure 2-6 and Figure 2-7. Further details regarding the Bellekeno P-AML WRSF can be found in the Issued for Use EBA (2009) report. All waste rock placed in the Bellekeno P-AML WRSF will be rehandled and placed underground at Bellekeno below the static water level.

The Flame & Moth temporary P-AML WRSF (Figure 2-3) has been designed to accommodate up to 12,000 tonnes of P-AML waste rock. The Flame & Moth WRSF is located adjacent to the mill coarse ore stockpile. The

site plan, profile, and cross section of the as-built Flame & Moth P-AML WRSF is shown in Figure 2-8. Further details regarding the Flame & Moth P-AML WRSF can be found in the Issued for Use EBA (2014) report. All waste rock placed in the Flame & Moth P-AML WRSF will be rehandled and placed underground at Flame & Moth below the static water level at closure.

Two P-AML WRSF have been proposed for the Birmingham mine (Figure 2-4). The two proposed P-AML WRSF design are based on the approved EBA design (EBA, 2008). The temporary P-AML WRSFs will be located at the top of the historic Birmingham waste rock dump. The first P-AML WRSF prepared for the Birmingham advanced exploration project has been designed up to 6,000 tonnes and the design details are outlined in (Tetra Tech, 2017, while the P-AML WRSF for the Birmingham Mine development and production program was 10,000 tonnes for a total of up to 16,000 tonnes. The as-built drawing of the first temporary P-AML facility for the Birmingham mine is presented in Figure 2-9. The detailed design for the second temporary P-AML facility will be added to the plan once advanced. All waste rock placed in the Birmingham P-AML WRSFs will be rehandled and placed underground at Birmingham below the static water level at closure.

Water management structures (e.g. berms, ditches and drainage channels) will be installed around the P-AML WRSF to ensure clean runoff are intercepted and diverted around the facility and contact water is channeled toward collection and monitoring ponds and appropriately managed. Temporary storage of P-AML waste rock will be within temporary P-AML pad adjacent to portal constructed with a cemented base fill for up to 30 days and either sent to the P-AML facility for longer term storage or placed back underground as backfill. EBA's Construction Specifications account for physical stability of the facility. The temporary P-AML storage facility is lined with CRF. The long-term storage facilities are lined with a suitable liner material including a 60-millimeter thick High-Density Polyethylene (HDPE) geomembrane protected by non-woven geotextiles and the seepage is collected and treated as required during operations.

Only precipitation will enter the P-AML WRSF, if precipitation accumulates within a P-AML waste rock storage facility it will be collected at the base of the facility by the liner. Depending on the amount of waste rock within the P-AML WRSF, most surface precipitation will be adsorbed by the rock. Should there be any ponded water it would be sampled and can be collected for treatment if required. Water quality monitoring stations within each P-AML facility have been included and are KV-78b (Bellekeno), KV-106 (Flame & Moth), and Birmingham (KV-115 and KV-119). As mentioned above, the P-AML WRSF are lined facilities and no seepage is anticipated and no surface runoff will enter the WRSF. Additionally, monitoring upgradient and downgradient monitoring of each P-AML facility is performed at stations KV-76 and KV-77 for Bellekeno, KV-86, KV-87, KV-89 and KV-108 for Flame & Moth, and BH-MW-1, KV-115 and KV-111 for Birmingham. These locations are outlined in the Monitoring, Surveillance and Reporting Plan.

WRSF and WRDAs will be cleared of vegetation and stripped of topsoil and the latter will be recovered and stockpiled for later use for reclamation works. The surface of WRSF and WRDAs will be slightly inclined toward the location of drainage and collection ponds and away from natural down gradient flow so that runoff from the surface is directed toward collection ponds.

2.2.3 WASTE ROCK HANDLING

Upon P-AML or N-AML determination as per the WRMP (Section 4), directions will be given for hauling and disposal of the waste rock. The N-AML waste rock will either be hauled by trucks to the N-AML WRDA and end-dumped or trucked to a location to be used for construction purposes. N-AML waste rock from Bellekeno and Flame & Moth mines can be used for construction without further screening, however, N-AML rock from

Birmingham must also possess a carbonate NPR > 2 to be considered for use in construction. The N-AML material in WRDA will then be spread in lifts by loaders and dozers. N-AML waste rock may be needed for underground backfill and would be sourced from the N-AML WRDA and backhauled underground.

P-AML waste rock will be preferentially used for underground mine backfill, but may be trucked to surface for future mine backfill depending on the development stage of the mine at that time. If P-AML waste rock is brought to surface it will first be trucked to the temporary P-AML stockpile or alternatively to the P-AML WRSF if no backfill is planned within 30 days. Trucks will end dump the P-AML waste rock in the PAML WRSF starting on the ramp side. As additional waste rock is required, the P-AML waste rock will be removed from the P-AML WRSF with a loader and trucked back underground to the active mine stop. A description of the waste rock handling and location by mine is presented in Table 2-2.

The tonnage of N-AML and P-AML waste rock brought to surface for each mine will be logged as part of the annual reporting requirements of Water Use Licence QZ18-044.

Table 2-2: Waste Rock Handling by Mine

Mine	N-AML Waste Rock	P-AML Waste Rock
Bellekeno	N-AML waste rock will be primarily used for construction purposes including the maintenance of the Bellekeno Haul road and mine laydown areas. As contingency, N-AML waste rock may be placed in the Bellekeno N-AML WRDA located adjacent to the Bellekeno Haul Road	Bellekeno P-AML waste rock will preferably be rehandled underground and used as mine backfill. As needed, P-AML waste rock will be brought to surface for temporary storage in the Bellekeno P-AML WRSF prior to be returned underground for use as mine backfill below the static water elevation once the mine is flooded at closure.
Flame & Moth	N-AML waste rock will be used for construction purposes within the Keno District Mill area including the expansion of laydown areas, P-AML WRSF construction, DSTF phase 2 expansion and rerouting of the Bellekeno Haul road Flame & Moth N-AML will also be used for underground mine backfill if P-AML waste rock is not available.	Flame & Moth P-AML waste rock will preferably be rehandled underground as used as mine backfill. As needed, P-AML waste rock will be brought to surface for temporary storage in the Flame & Moth P-AML WRSF prior to be returned underground for use as mine backfill below the static water elevation once the mine is flooded at closure.
Birmingham	N-AML waste rock with carbonate NPR > 2 will be used for construction purposes where needed including the expansion of the Birmingham portal area to support development activities, and road construction/maintenance. If N-AML waste rock is not needed for construction or is inadequate for it (N-AML with carbonate NPR < 2) then it will be placed within the Birmingham N-AML WRDA. Birmingham N-AML will also be used for underground mine backfill if P-AML waste rock is not available.	A temporary P-AML storage facility is located on the historic Birmingham waste rock dump. A second P-AML facility may be built if the first temporary facility capacity is exceeded. The PAML rock will be used preferentially as backfill, and the P-AML rock may come to surface temporarily to be stored within the temporary facility prior to being used underground as backfill.

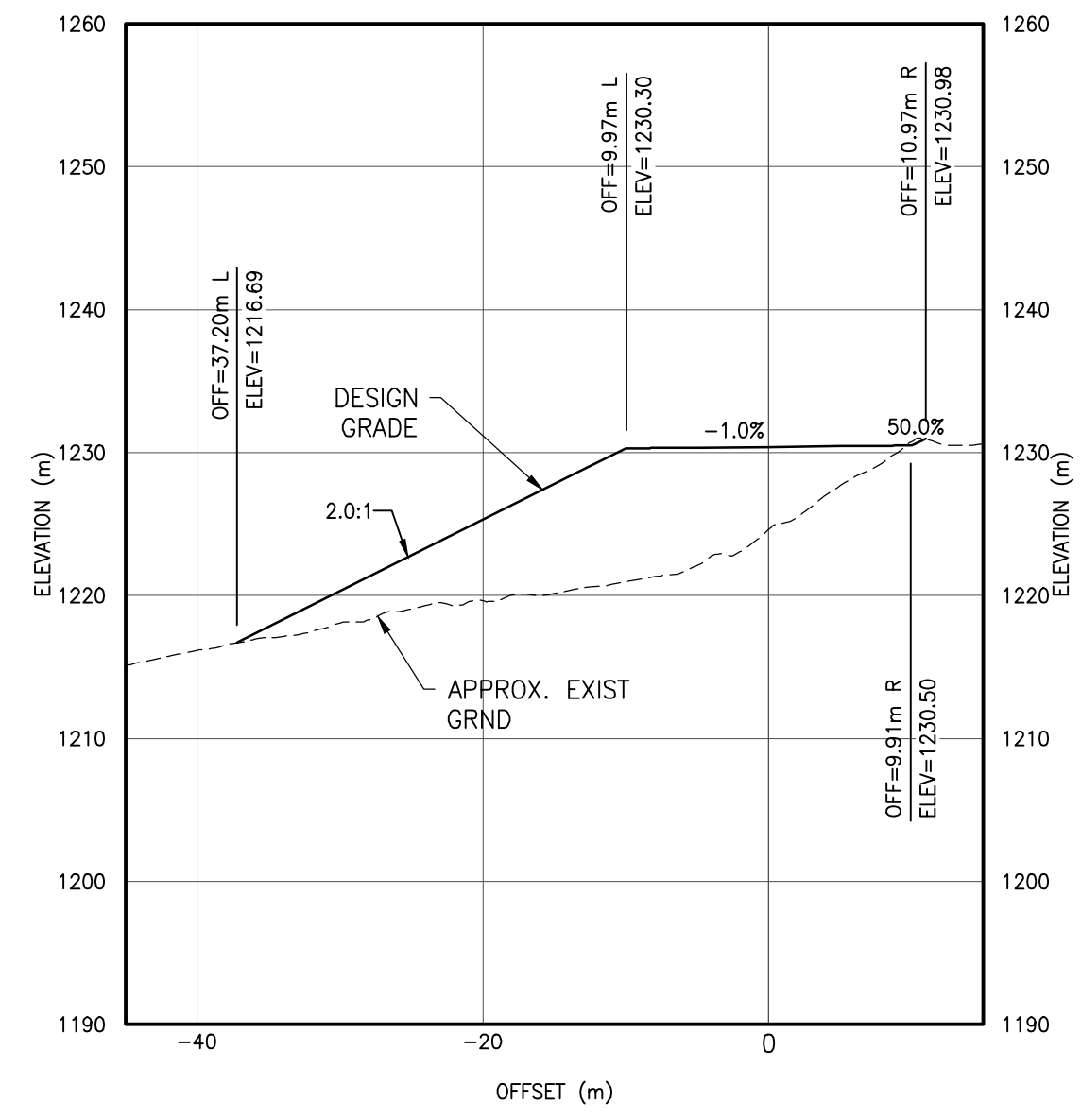

1 END DUMP SECTION
SCALE: 1:500

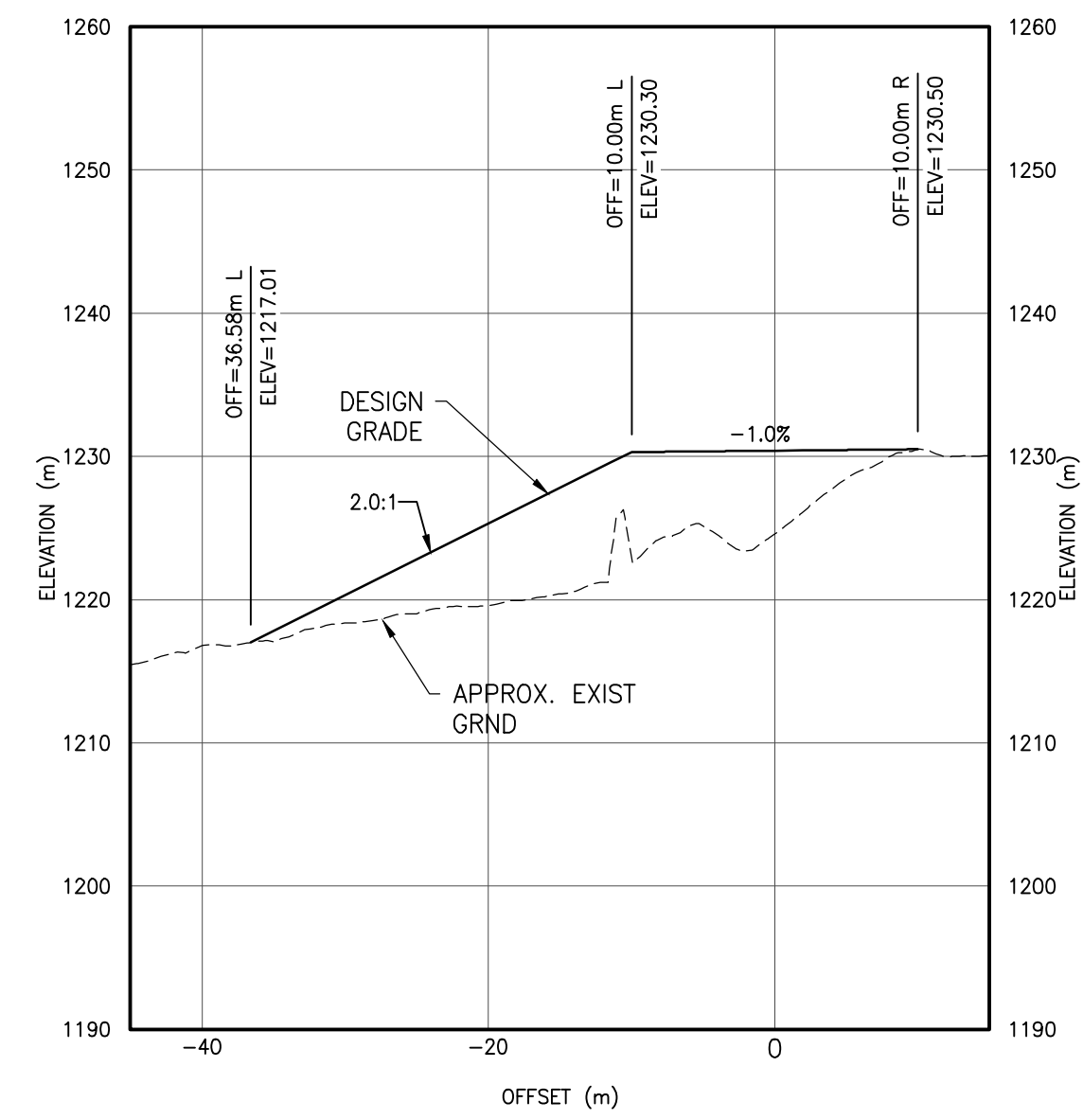

2 END DUMP SECTION
SCALE: 1:500

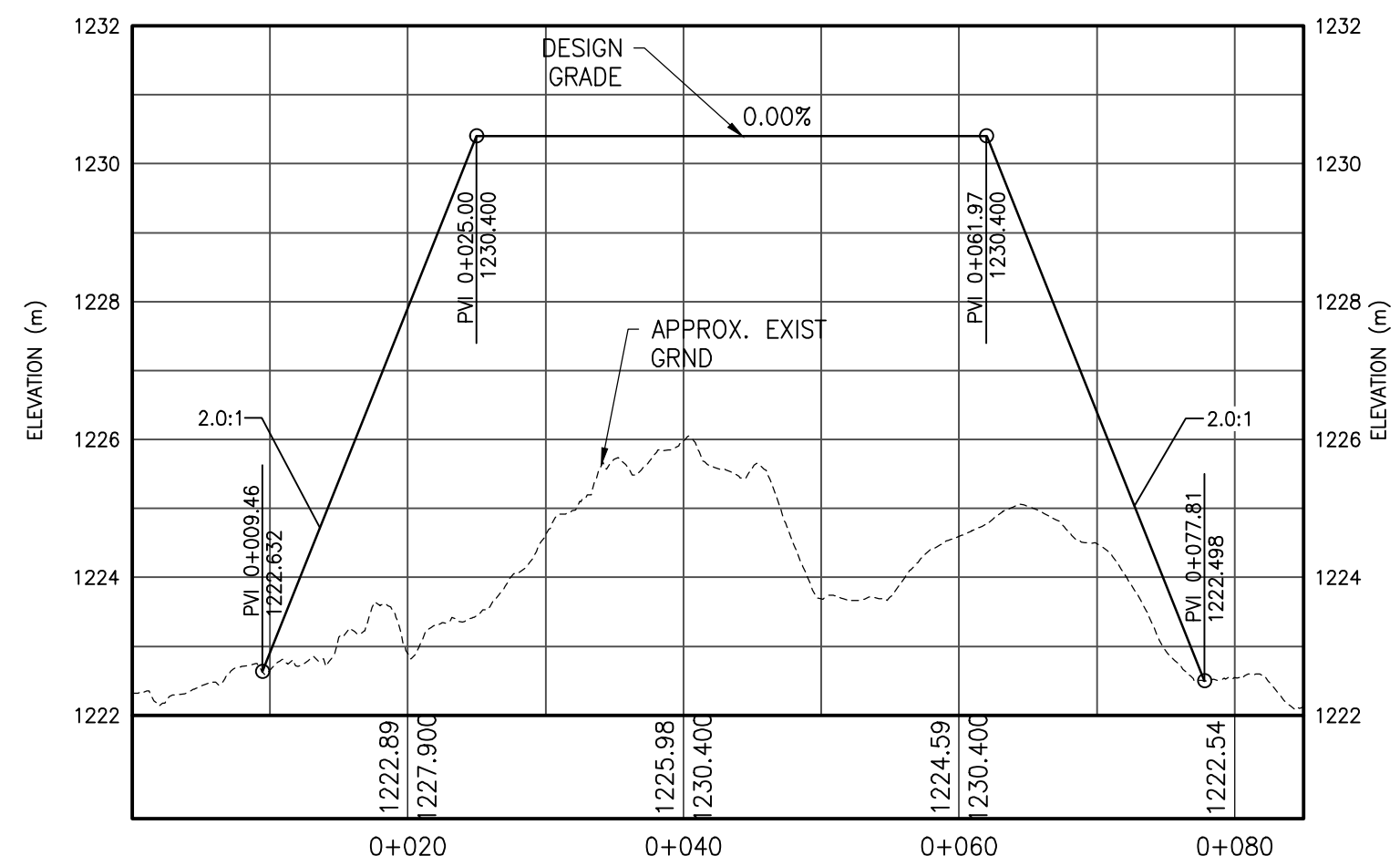

A-A' END DUMP PROFILE
SCALE: 1:500 (5X VERT)

2020 TESTPIT LOCATIONS				
POINT NO.	DESC.	NORTHING	EASTING	ELEV.
1	TP20-01	7087359.117	478605.489	1218.389
2	TP20-02	7087377.985	478560.354	1212.227
3	TP20-03	7087361.337	478519.659	1211.397
4	TP20-04	7087337.290	478474.894	1211.215
5	TP20-05	7087310.653	478434.199	1210.903
6	TP20-06	7087251.830	478435.678	1219.513

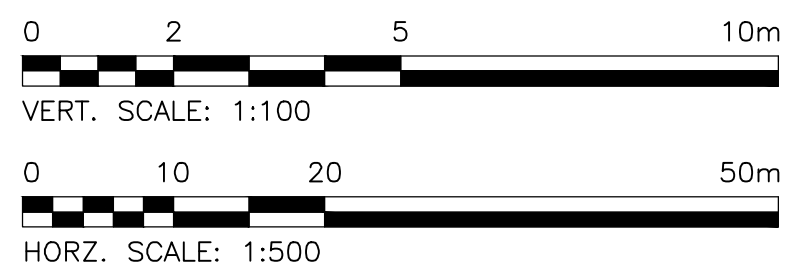

Cut/Fill Report

Generated: 2021-03-29 08:48:18
By user: CLARK.SPENCER
Drawing: C:\pwworking\can_infra\dms05942\C:\pwworking\can_infra\dms05942\C-101.dwg

Volume Summary							
Name	Type	Cut Factor	Fill Factor	2d Area (sq.m)	Cut (Cu. M.)	Fill (Cu. M.)	Net (Cu. M.)
VOL_DSGN_FILL	fill	1.000	1.000	3096.61	9.88	12381.92	12372.04-Fill>
Totals				2d Area (sq.m)	Cut (Cu. M.)	Fill (Cu. M.)	Net (Cu. M.)
				3096.61	9.88	12381.92	12372.04-Fill>

* Value adjusted by cut or fill factor other than 1.0

DESIGN VOLUME REPORT



CONSULTANTS

SEALS / STATUS



**BIRMINGHAM NAML
WASTE DUMP DESIGN**
Figure 2-5

KENO HILL SILVER DISTRICT
YUKON TERRITORY, CANADA

MARK	DESCRIPTION	DATE	APP'D
0	ISSUED FOR USE	2021/07/05	T.P.

PROJECT NO : ENG.WARC03961-01
CONTRACT NO : N/A
DRAFTING BY : C.SPENCER
DESIGN BY : C.SPENCER
CHECKED BY : T.PASLOSK

**GENERAL ARRANGMENT
NAML DUMP DESIGN
PROFILE - CROSS SECTIONS
AND VOL. REPORT**

DRAWING NUMBER
C-101

ISSUED FOR USE

PLOT DATE: 2021/07/05 AT 12:01:11 PLOTTED BY: SPENCER, CLARK
CADD FILE: C:\PWWORKING\CAN_INFRA\DMS05942\C-101.DWG [C-101]

50 mm

O:\keno\W14101142 Onek Waste Containment Facility - Design\001 - Bellekeno P-AML Waste Facility\Bellekeno East P-AML Facility\20090727.dwg [FIGURE 1] July 30, 2009 - 2:12:57 pm (BY: CHRIS DIXON)

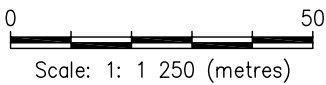
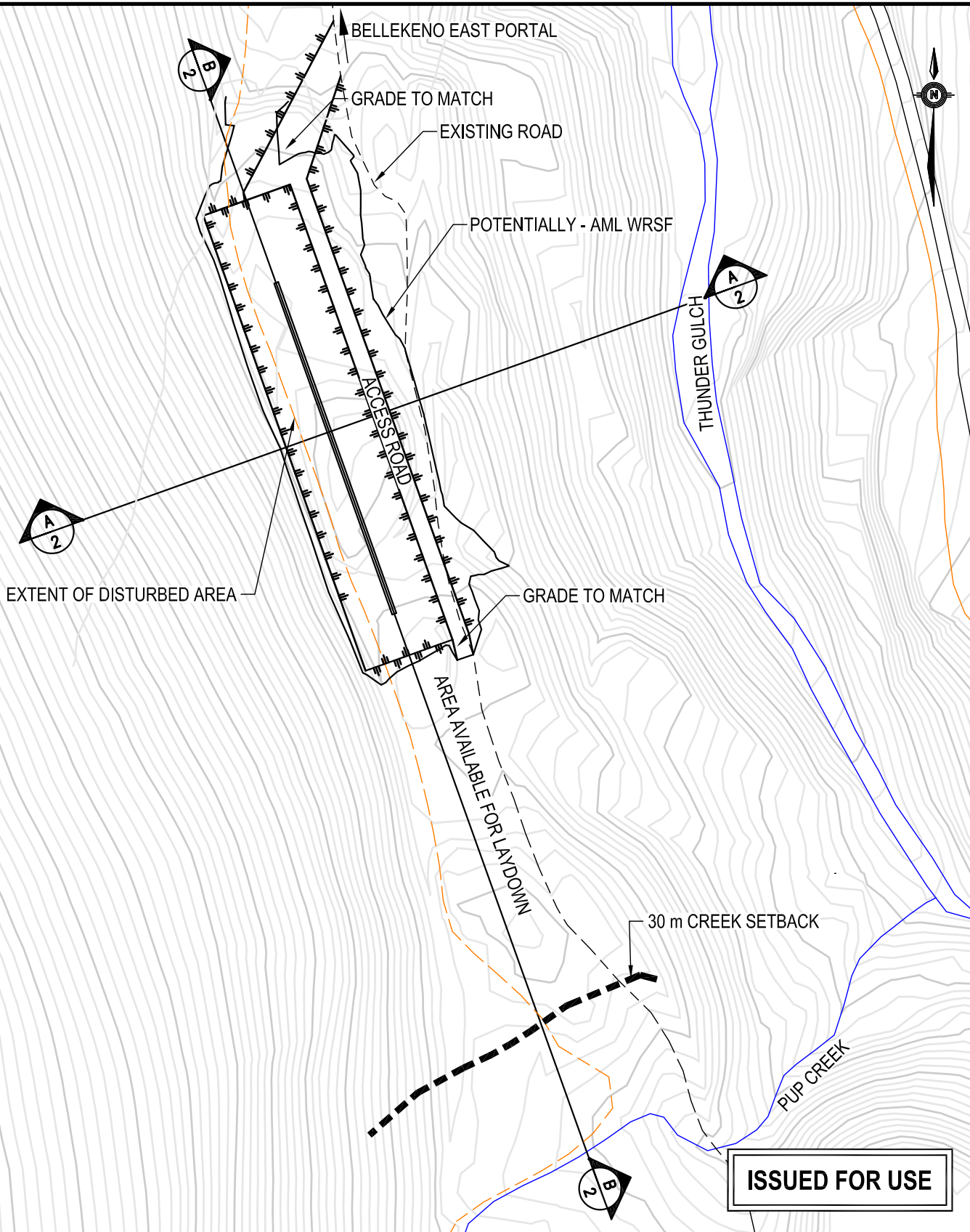

CLIENT



EBA Engineering Consultants Ltd.

**TEMPORARY WASTE CONTAINMENT FACILITY
BELLEKENO EAST SITE**

**BELLEKENO EAST P-AML SITE
SITE PLAN**

PROJECT NO. W14101142.001	DWN KJT	CKD CJD	REV 0
OFFICE EBA-WHSE	DATE July 30, 2009		

Figure 2-6

O:\Keno\W14101142 Onek Waste Containment Facility - Design\001 - Bellekeno P-AML Waste Facility\Bellekeno East P-AML Facility-20090727.dwg [FIGURE 2] July 30, 2009 - 2:12:22 pm (BY: CHRIS DIXON)

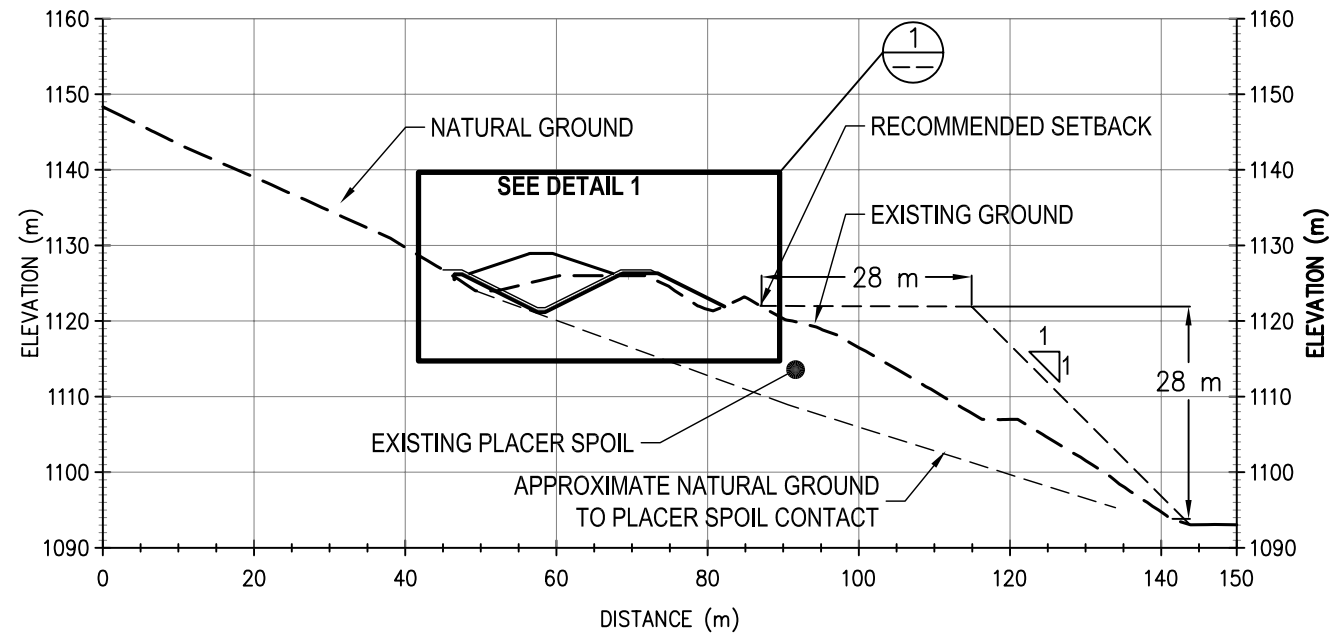

CROSS-SECTION **A**
SCALE: 1 : 1000 **1**

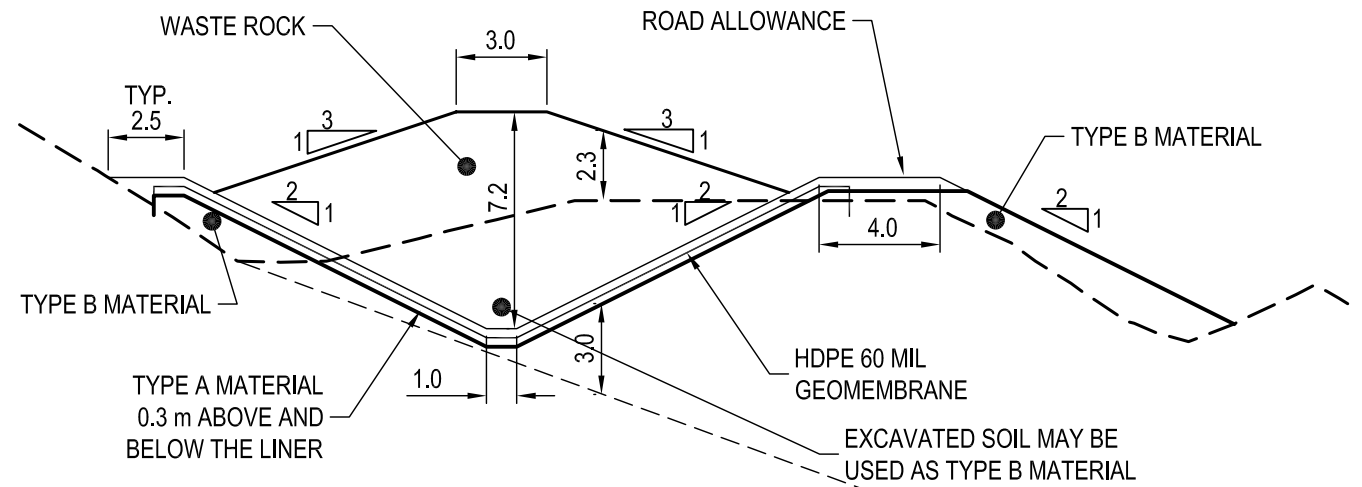

DETAIL **1**
SCALE: 1 : 250 **1**

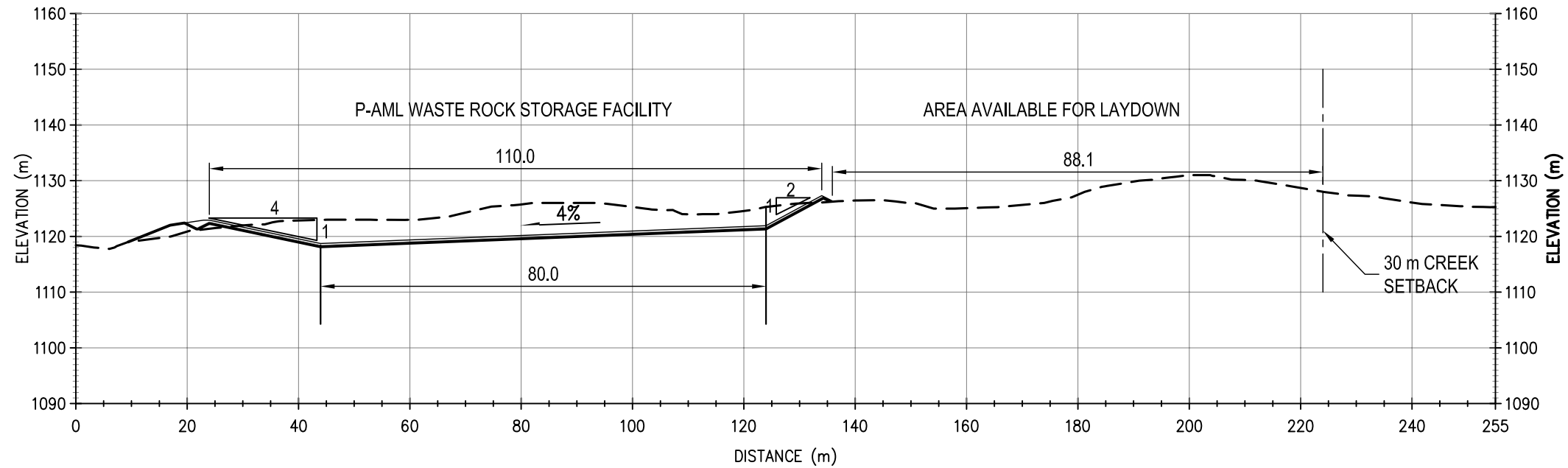

PROFILE **B**
SCALE: 1 : 1000 **1**

ISSUED FOR USE

LEGEND

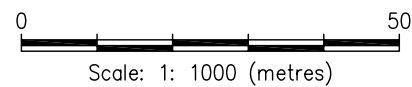

CLIENT



**BELLEKENO EAST P-AML WASTE ROCK STORAGE
KENO CITY, YUKON**

PROFILE, SECTION AND DETAIL

**EBA Engineering
Consultants Ltd.**



PROJECT NO. W14101142.001	DWN KJT	CKD CJD	REV 0
OFFICE WHSE	DATE July 27, 2009		

Figure 2-7

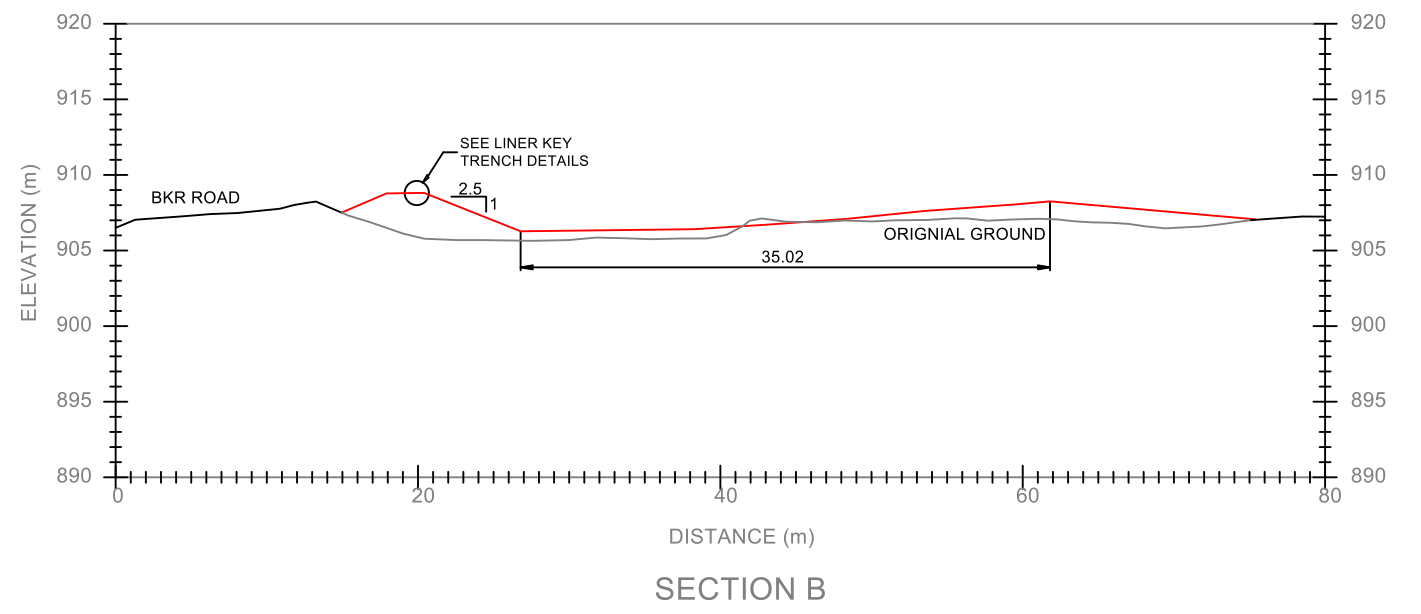
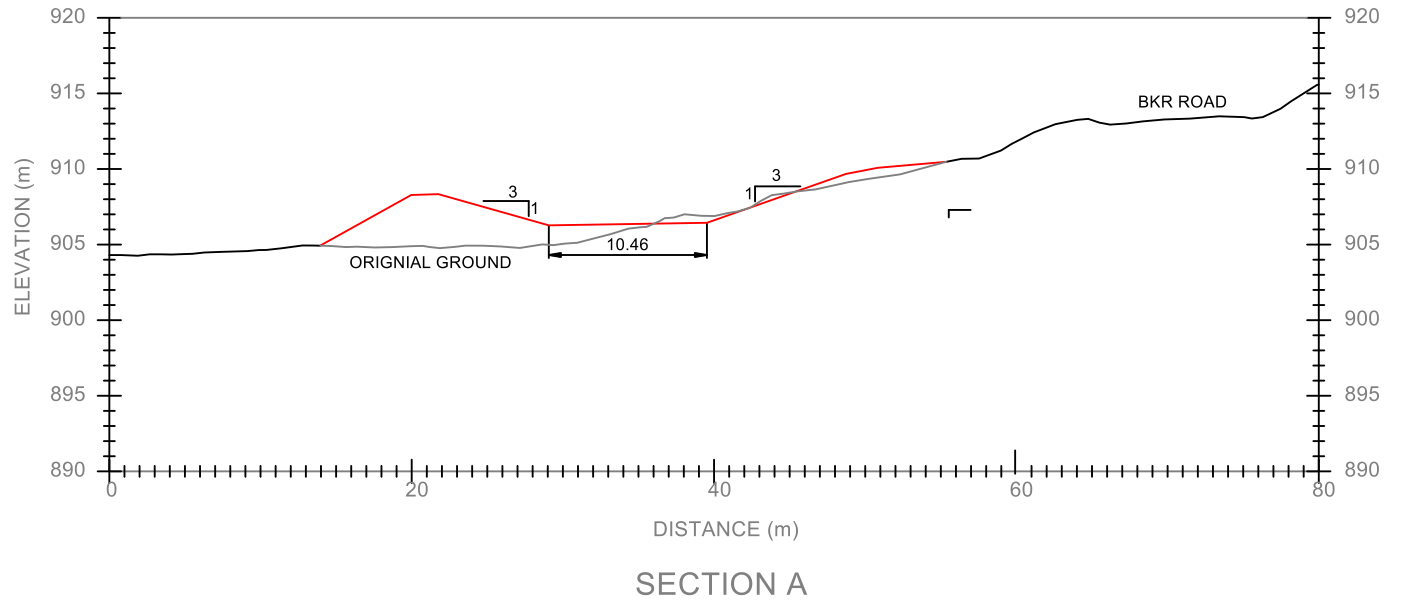
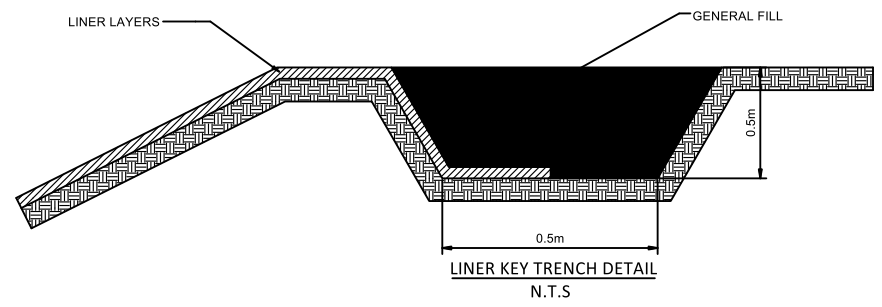
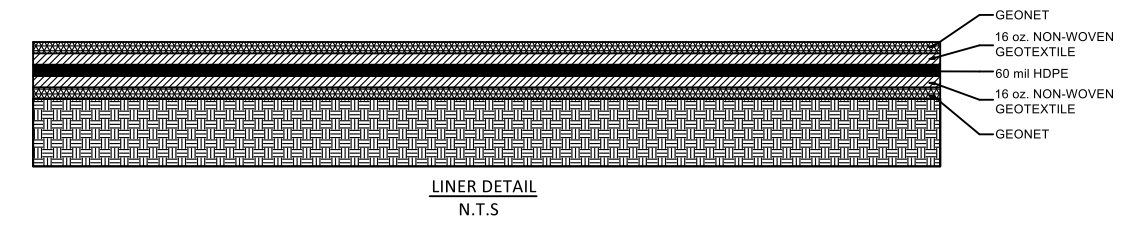
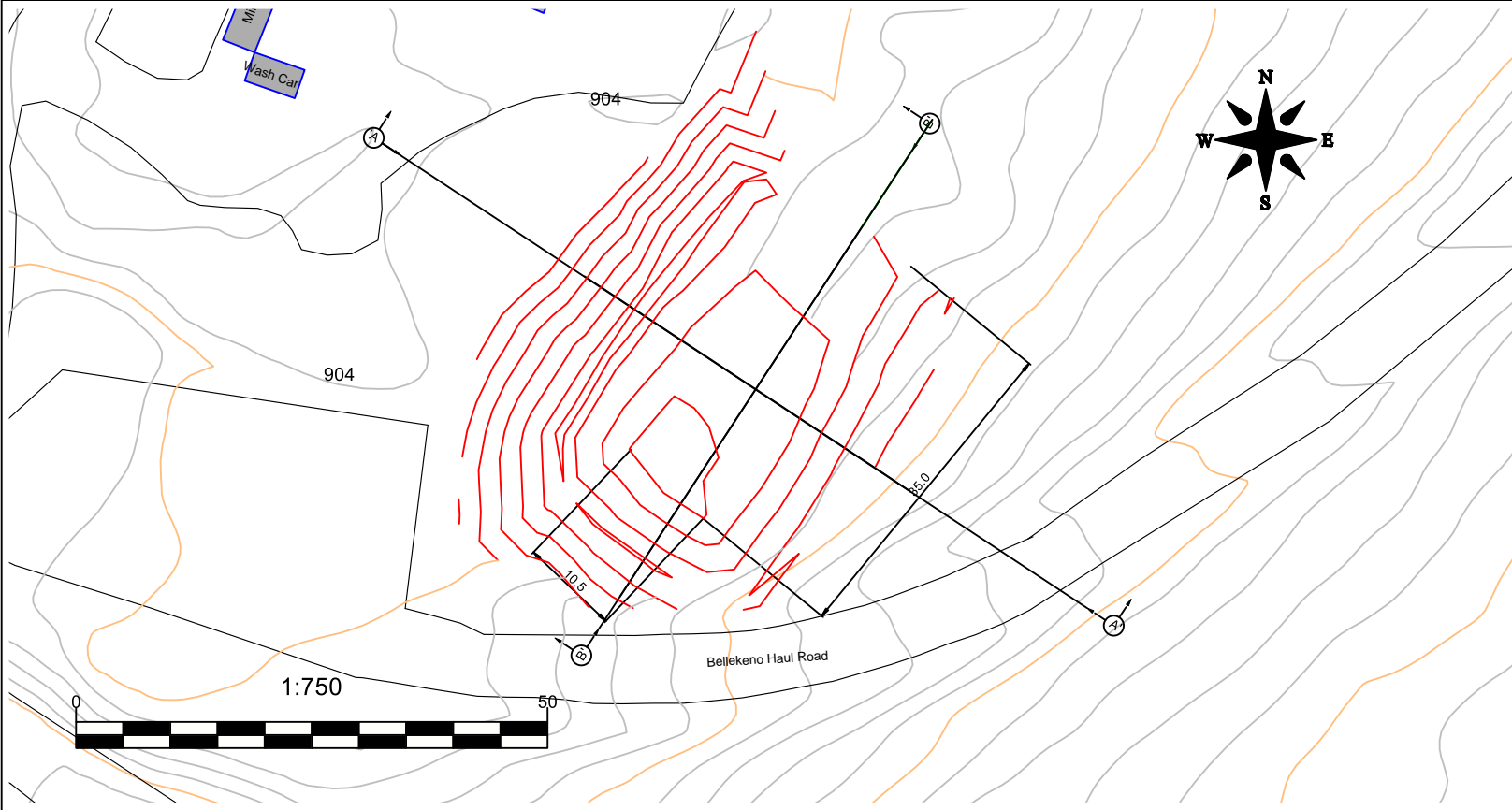

Rev	Rev. Date	Description	Drwn	Chkd	Geo
1	10/22/2020	Drawn from FM P-NAML Pad survey.			
2					
3					
4					
5					
6					
7					
8					
9					

LOCATION: Mill Site Rev No.

Flame & Moth P-AML Pad

Drawn by	D.Silander	Figure 2-8
Date Drawn	22/10/2020	
Scale	1:500	

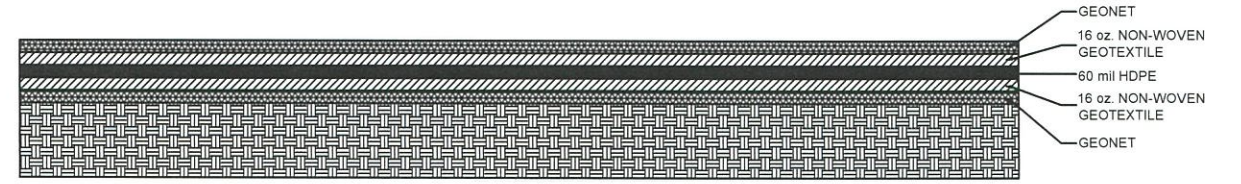

LINER DETAIL
N.T.S

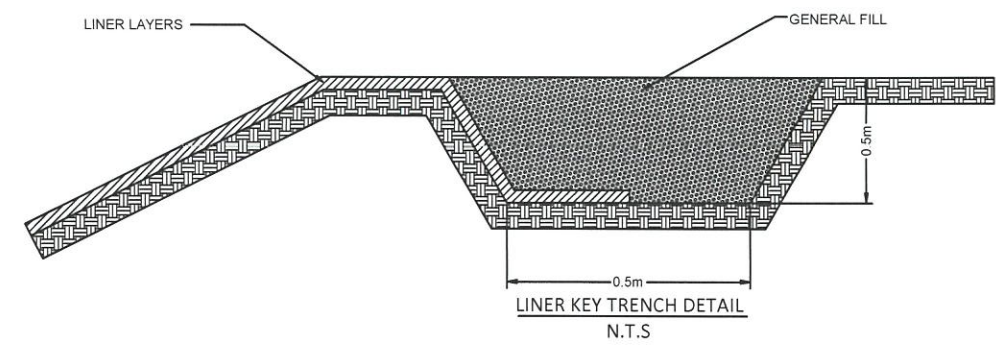

LINER KEY TRENCH DETAIL
N.T.S

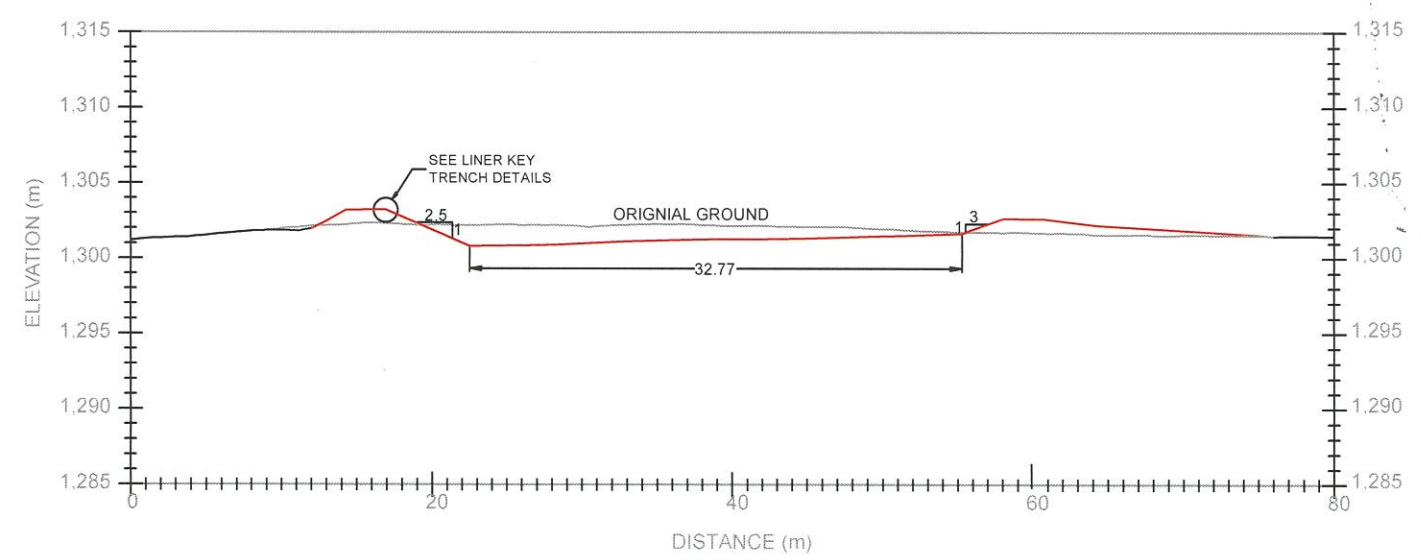

SECTION A

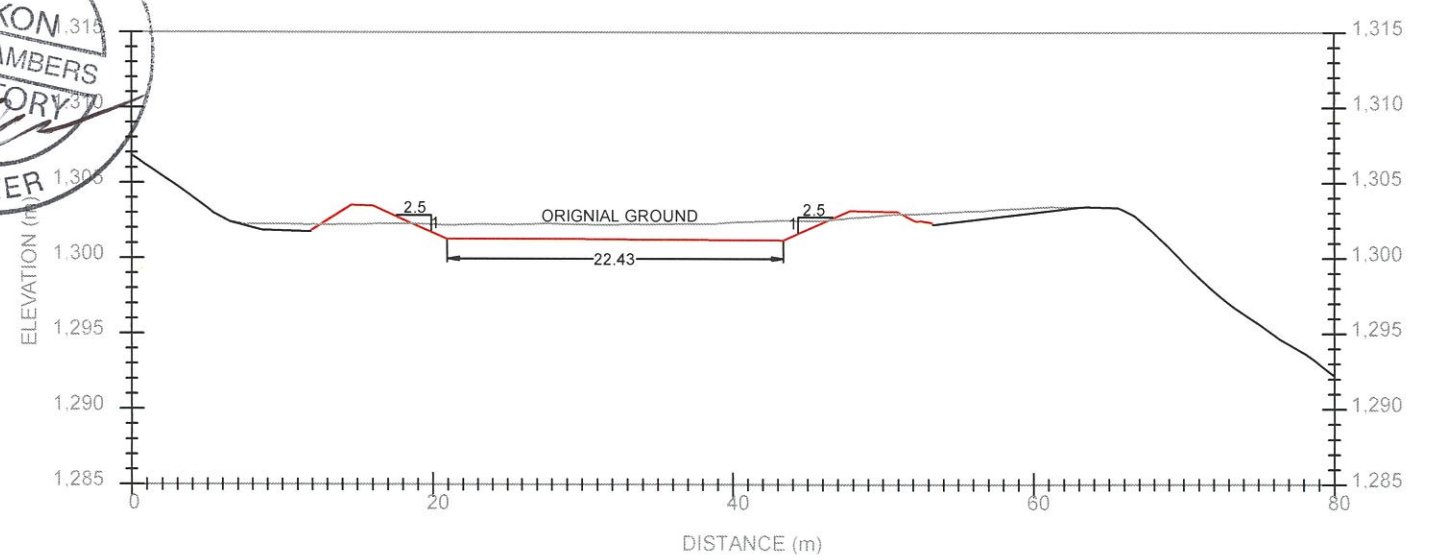
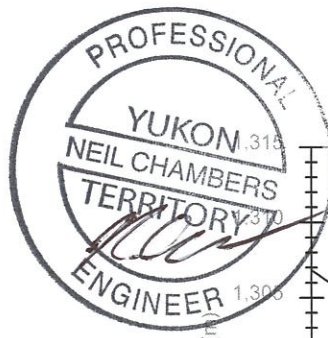

SECTION B



Rev	Rev. Date	Description	Drwn	Chkd	Geo
1	10/19/2020	Drawn from Bermingham P-NAML Pad survey.			
2					
3					
4					
5					
6					
7					
8					
9					

LOCATION: Bermingham Waste Dump		Rev No.
Bermingham P-AML Pad		
Drawn by	D.Silander	Figure 2-9
Date Drawn	19/10/2020	
Scale	1:500	



3. ROCK CHARACTERIZATION

3.1 SUMMARY OF ROCK CHARACTERIZATION

Studies conducted throughout the Keno Hill Silver District (KHSD) and specifically within each of the mineralized target zones (Bellekeno, Flame & Moth, and Bermingham) provide a foundation for correlating and understanding the weathering behavior or geo-environmental characteristics of rock in the KHSD.

Although the Lucky Queen and Onek 990 deposits do not form part of the permitted operations, geochemical characterization data from waste rock collected from both deposits were included in the development of waste rock management criteria. A summary of these waste rock characterization studies and the key results is shown in Figure 3-1.

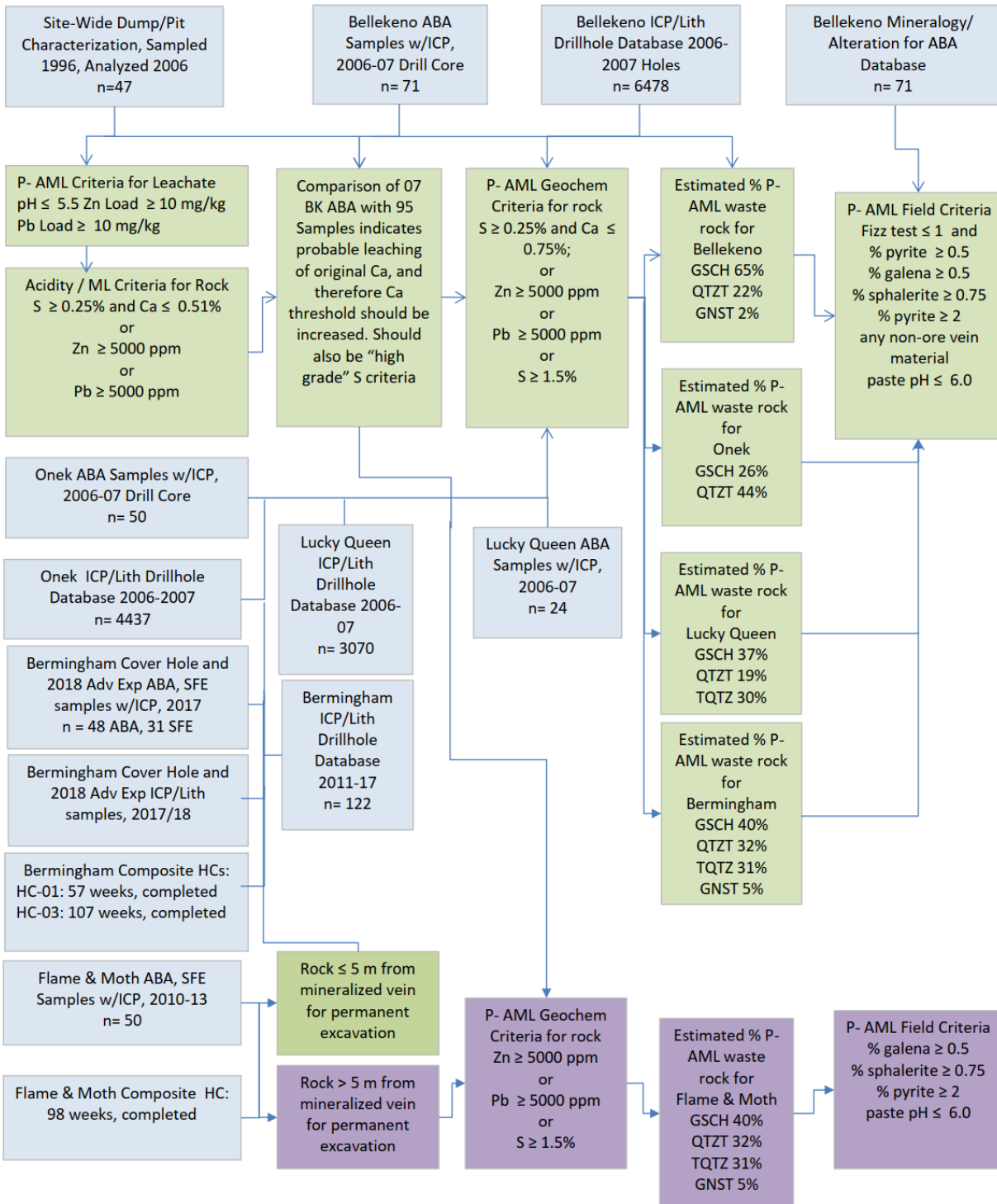

Figure 3-1: Keno Hill Development Waste Rock Characterization Studies – Components and Key Results

3.2 SUMMARY OF FLAME & MOTH WASTE ROCK CHARACTERIZATION

The geoenvironmental evaluations to support the original Bellekeno Waste Rock Management Plan (WRMP) consisted of analysis and integration of four specific data components:

1. Site-wide studies on weathered rock (47 samples);
2. Acid-base accounting of 2006-2007 Bellekeno drill core (71 samples);
3. Bellekeno drillhole multi-element and lithology database (6,478 samples); and
4. Mineralogy and alteration logging data on acid base accounting samples.

In order to support the extension of use of the WRMP for the Flame & Moth deposit, analysis of additional data components was undertaken, specifically:

5. ABA on 2010-2012 Flame & Moth drill core sourced from area of proposed excavation (50 samples);
6. Multi-element and lithology database 2010-2012 Flame & Moth drill core sourced from area of proposed excavation (50 samples);
7. Shake flask extraction (SFE) test results from 2010-2012 Flame & Moth drill core sourced from area of proposed excavation (50 samples); and
8. Humidity cell results (weeks 0-98) of a composite sample created from Flame & Moth drill core sourced from area of proposed excavation.

In order to support the extension of use of the WRMP for the Birmingham deposit, analysis of additional components was undertaken, specifically:

1. ABA on 2017 and 2018 Birmingham cover hole core sourced from the proposed exploration decline and rock core from 2018 advanced exploration drill holes proximal to the mineralization (48 samples);
2. Multi-element and lithology database on 2017 and 2018 Birmingham cover hole core sourced from the proposed exploration decline and rock core from 2018 advanced exploration drill holes (181 samples);
3. SFE testing on 2017 and 2018 Birmingham cover hole drill core sourced from the proposed exploration decline and 2018 advanced rock core from exploration drill holes (31 samples);
4. X-ray diffraction (XRD) results (4 samples);
5. Historic studies of historic Birmingham pit waste rock (12 ABA samples, 8 multi-element and SFE analyses);
6. Multi-element and lithology database on 2011-17 Birmingham exploration drill core proximate to the proposed mine workings and closer to the vein mineralization (122 samples); and
7. Two humidity cells (one terminated after 57 weeks and a second initiated in late February 2019) of composite samples created from Birmingham cover hole and 2018 advanced exploration drill core proximal to the mineralization, respectively. The latter humidity cell sample was carefully selected to test N-AML waste rock with sulphide sulphur content close to the 80th percentile.

Although not included in the water licence, the following geochemical data for waste rock collected from the Onek and Lucky Queen deposits were also included in the WRMP development:

1. ABA on 2008-2010 Lucky Queen drill core (24 samples);
2. Lucky Queen multi-element and lithology database (3070 samples);
3. ABA on 2008-2010 Onek drill core (50 samples); and
4. Onek multi-element and lithology database (4437 samples).

These studies were used to derive the following components for the WRMP:

1. P-AML geochemical screening criteria for each deposit;
2. Estimated proportions of P-AML and N-AML material by rock type for the proposed development activities at each of the deposits; and
3. Field criteria for differentiating P-AML and N-AML rock during excavation activities at each deposit.

3.3 SUMMARY OF BIRMINGHAM WASTE ROCK CHARACTERIZATION

The potential for ARD/ML related to waste rock excavated from the Birmingham deposit was assessed using static and kinetic tests test results discussed in Appendix A.

The results of the characterization work conducted to date are compiled in several reports and technical memoranda including (AEG, 2018a, and 2019a). As outlined in Appendix A, a second humidity cell was initiated in February 2019 to predict the water quality potentially resulting from N-AML waste rock with elevated sulphide sulphur (~ 80th percentile). This cell was terminated on March 16, 2021 after 107 weeks of operation. The highlights of the results are provided below:

- Approximately half (48%) of waste rock samples collected from Birmingham were non-PAG (i.e., NPR>2), 29% were PAG and 23% were classified as uncertain largely due to low NP and acid potential (AP);
- The third quartile of bulk concentrations of antimony, arsenic, silver, zinc, cadmium, and selenium often exceed their respective average crustal abundances by an order of magnitude (CRC, 2005) in the Birmingham waste rock;
- The results of shake flask extraction (SFE) testing were compared to Canadian Council of Ministers of the Environment (CCME, 2017) or British Columbia Ministry of the Environment (BCMOE, 2016) chronic water quality guidelines for freshwater aquatic life to preliminarily assess for potential elevated leachable concentrations of metal(loid)s. Concentrations of leachable fluoride, aluminum, antimony, arsenic, cadmium and selenium exceeded CCME or BCMOE guidelines in at least one Birmingham SFE sample. The highest percentage exceedances were observed for selenium, fluoride (45%) and arsenic (31%);
- The results of 57 weeks of humidity cell testing of N-AML waste rock with low sulphide sulphur content (0.08 wt.%) has shown that the material leachate pH remained circumneutral (pH 6.7 to 7.6), with low alkalinity (4.5 to 16 mg/L as CaCO₃) and only negligible acidity (below or at the detection limit of 0.5 mg/L as CaCO₃) released. Leachable sulphate concentrations were also low (2.5 and 15.3 mg/L). The 107 weeks of kinetic test on N-AML waster rock with higher sulphide sulphur (0.36 wt.%) has also shown that the leachate pH remained circumneutral (pH 7.3 to 8.1), with low level of alkalinity (9.0 to 42 mg/L as CaCO₃) and negligible acidity (below the detection limit of 0.5 to 1.1 mg/L

as CaCO₃) released. Leachable sulphate concentrations were also low but higher than the cell with lower sulphide sulphur (10 and 42.8 mg/L);

- The leachable concentrations of all metal(oids) in the Bermingham humidity cell leachates were at least one order of magnitude below the WQO, EQS, BCMOE / CCME guidelines except selenium, and antimony that exceeded the BCMOE during the first eleven weeks of testing. Copper also exceeded the WQO during two isolated cycles. Selenium and antimony concentrations peaked (0.009 and 0.013 mg/L, respectively) after week one, then continued to decline gradually such that by week 11, they were below their respective BCMOE guidelines (0.002 and 0.009 mg/L, respectively); and
- The calculation of lag time to sulphide and NP depletion for the cell with lower sulphide sulphur revealed that the sulphide sulphur and NP will be depleted in 21 and 39 years, respectively, while the cell higher sulphide sulphur provided a shorter sulphide depletion time (18 years) and NP depletion time (21 years). This suggests that a significant portion of NP will remain in the low sulphide sulphur cell but only some amount of NP will remain in the cell with higher sulphide sulphur after their sulphide minerals have been oxidized. Static and mineralogical tests on the residues of the cells show that adequate amount of NP to buffer the acidity generated from the low sulphide sulphur present was present. The potential for long-term acid generation and metal leaching from the Bermingham N-AML waste rock is thus predicted to be low.

3.4 WASTE ROCK CATEGORIES

Waste rock excavated from underground operations can be categorized into the following categories:

- N-AML: Rock of non-economic grade, expected to be comprised of over 85% Central Quartzite unit (quartzite typically intercalated with minor amounts of schist), and less than 15% Greenstone. As presented in Section 1.2, the majority of the waste rock excavated is expected to be N-AML; rock field-classified as N-AML will be stored in designated locations on site. N-AML from Flame & Moth, and Bellekeno mines can be used for construction purposes where needed without further consideration, but the N-AML waste rock from Bermingham must also have carbonate-based NPR > 2 to be used as construction material. Figure 3-2 shows how the N-AML from Flame & Moth, Bellekeno and Bermingham will be categorized and assessed for suitability for construction;
- P-AML: Waste Rock and Mineralized Waste Rock of no Economic Interest: Rocks field-classified as P-AML (mainly pyrite rich graphitic schist) will be stored in designated P-AML waste rock storage facilities during advanced exploration, development and production and later permanently stored underground as cemented back fill within excavated stopes at closure. In addition to P-AML wall rocks, some vein material especially along the margins of zoned veins contain mostly gangue minerals such as siderite, pyrite and quartz but do not contain economic amounts of Ag, Zn, or Pb minerals and therefore are of no economic interest. Due to their increased likelihood for acidic or metal leaching, all such mineralized non-economic rock is considered to be P-AML and will be stored in P-AML waste rock storage facilities or permanently stored underground as cemented back fill within excavated stopes; and
- Mineralized Rock of Uncertain Economic Interest: Vein material which contains significant Ag, Zn or Pb minerals but is not obviously economic may be temporarily stockpiled at the mine site or mill site on lined contained pads. Confirmatory assay will determine whether this rock is milled or is sent to the P-AML waste rock storage facility or hauled back underground.

Table 3-1 summarizes waste rock management categories and handling. Included for each category are environmental characteristics, use and storage specifications, geochemical criteria, and field screening criteria.

Table 3-1: Waste Rock Categories and Management

	P-AML Waste Rock	N-AML Waste Rock	Mineralized Rock
Environmental Characteristics	Potentially acid-generating and/or metal leaching	Non- acid-generating and non-metal leaching	Ag, Pb, and Zn grades of economic interest. May contain minerals with potential for net acidity and/or metal leaching
Uses and Storage	Not suitable for general construction purposes To be temporarily stored within lined P-AML WRSFs, Some P-AML material will be removed from P-AML WRSFs and returned for underground backfill at closure	May be used for general construction purposes but must also have a carbonate NPR greater than 2 if sourced from Birmingham deposit	May be stockpiled temporarily at the portal sites or mill, then either milled or sent to P-AML waste rock storage facility

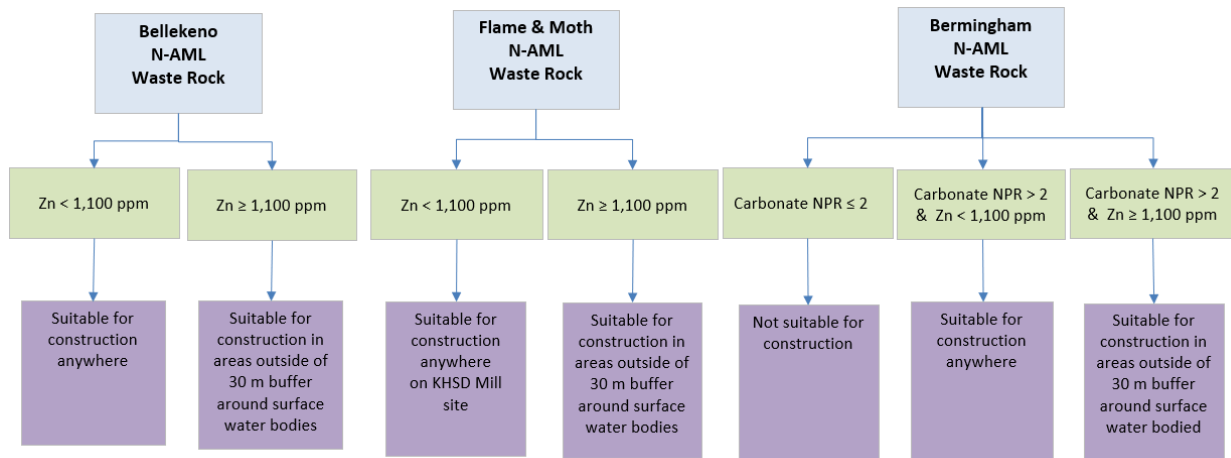

Figure 3-2: Keno Hill Development N-AML Categorization

3.5 RESULTS FROM GEOCHEMICAL STUDIES APPLIED TO ROCK CHARACTERIZATION

The field procedures for applying the geochemical criteria to waste rock management are discussed in Chapter 4. The criteria as developed from the testing are as follows in this section.

3.5.1 P-AML WASTE ROCK GEOCHEMICAL SCREENING CRITERIA FROM ANALYTICAL DATA

The standard Bellekeno geochemical screening criteria for identification of P-AML rock apply to all rock excavated from the Bellekeno deposit. The standard geochemical criteria are as follows:

- $Ca\% \leq 0.75\%$ and $S \text{ via ICP} \geq 0.25\%$; or
- $S \text{ via ICP} \geq 1.5\%$; or
- $Pb \text{ via ICP} \geq 5000 \text{ ppm}$; or
- $Zn \text{ via ICP} \geq 5000 \text{ ppm}$.

In accordance with AEG 2016, geochemical screening criteria for identification of P-AML Flame & Moth rock distal to the mineralized vein (≥ 5 m or the presence of vein associated stringers, whichever is further) is as follows:

- S via ICP $\geq 1.5\%$; or
- Pb via ICP ≥ 5000 ppm; or
- Zn via ICP ≥ 5000 ppm.

In accordance with AEG 2019, geochemical screening criteria for identification of P-AML Birmingham rock are:

- Ca% $\leq 0.75\%$ and S via ICP $\geq 0.25\%$; or
- S via ICP $\geq 1.5\%$; or
- Pb via ICP ≥ 5000 ppm; or
- Zn via ICP ≥ 5000 ppm.

Evaluation of the Birmingham geoenvironmental dataset indicated that the both the Flame & Moth and Bellekeno geochemical screening criteria were adequate for segregating P-AML and N-AML waste rock for storage and disposal (AEG, 2019a); however, the more stringent Bellekeno criteria are proposed for separation of Birmingham P-AML / N-AML rock.

The neutralization capacity of the waste rock across the district has been the subject of study. Briefly; as noted in AEG (2019a), a distinguishing feature of the Birmingham waste rock is its relatively low neutralization potential (NP) compared to waste rock from other deposits. As such, the effective NP (i.e., that which is readily available for acid neutralization) was considered in the development of additional screening criteria for construction purposes. This is to ensure that low NP potential acid generating (PAG) rock that is not effectively captured by the Bellekeno screening criteria is not used for construction outside of the Birmingham portal area.

Comparison of the siderite-corrected NP with the carbonate NP indicates that the siderite-corrected NP exceeded the carbonate NP in almost all the Birmingham waste rock samples analyzed (44 of 48 ABA samples). This suggests that the ferrous carbonate component of the carbonate NP in Birmingham waste rock is relatively minor. Furthermore, the difference between the siderite-corrected NP and carbonate NP is generally assumed to reflect the contribution of aluminosilicate minerals to the bulk NP, which react more slowly than carbonate minerals to acid neutralization.

Therefore, to produce a more conservative set of screening criteria for construction rock, this aluminosilicate component can be removed and only the carbonate NP considered. Consequently, Birmingham waste rock for construction purposes must be both N-AML based on the Bellekeno screening criteria and have a carbonate neutralization potential (NPR) >2 . The carbonate NPR for a sample is calculated by dividing the carbonate NP by the AP. This provides additional conservatism to ensure that only non-acid generating waste rock is diverted for construction.

Finally, YESAB recommended that AKHM establish a maximum zinc concentration for the use of N-AML waste rock as construction material near surface water. Appendix B, Review of Net Acid Generation and Metal Leaching Controlling factors – Keno Hill Silver District outlines the method for determining the zinc threshold of 1100 ppm zinc for placement of N-AML waste rock within 30 m of a surface water body.

3.5.2 ESTIMATED PROPORTIONS OF P-AML AND N-AML ROCK

Applying the geochemical screening criteria to the waste rock drill hole databases for each deposit for the current mine plan shows the proportions of P-AML rock estimated for each lithology. Table 3-2 to Table 3-4 present the results for Bellekeno, Flame & Moth, and Bermingham.

Table 3-2: Proportion of Samples Filtered as P-AML in Bellekeno Waste Rock Drillhole Database

Lithology		Number of Samples in Database	Number of Samples Screened as P-AML	Percentage of Samples Screened as P-AML
Description	Code			
Chloritic Schist	CHSCH	222	27	12%
Calcareous Quartzite	CQTZT	505	54	11%
Greenstone	GNST	567	10	2%
Graphitic Schist	GSCH	870	562	65%
Quartzite	QTZT	3293	719	22%
Schist, Undifferentiated	SCH	775	299	39%
Sericitic Schist	SSCH	205	37	18%

Table 3-3: Proportion of Samples Filtered as P-AML in Flame & Moth Area of Proposed Excavation

Lithology		Number of Samples	# of P-AML Samples	% of P-AML Samples
Description	Code			
Graphitic Schist	GSCH	5	2	40%
Quartzite	QZT	28	1	4%
Thin Bedded Quartzite	TQZT	7	0	0%
Sericite Schist	SSCH	6	0	0%
Calcareous Quartzite	CQZT	2	0	0%
Greenstone	GNST	1	0	0%
Calcareous Schist	CSCH	1	0	0%
	Total	50	3	6%

Table 3-4: Proportion of Samples Filtered as P-AML in Bermingham Area of Proposed Excavation

Lithology		Number of Samples	# of P-AML Samples	% of P-AML Samples
Description	Code			
Quartzite	QZT	162	52	32%
Thin Bedded Quartzite	TQZT	55	17	31%
Greenstone	GNST	21	1	5%
Graphitic Schist	GSCH	43	17	40%
	Total	281	87	31%

Note: Lithology units that comprise <5% combined cover hole and drill core assay database are not presented here (SSCH, CQTZT)

4. ROCK MANAGEMENT

One of the primary strategies of the Waste Rock Management Plan for mitigating the occurrence of acid and/or metal leaching from the waste rock storage area is the appropriate classification of waste rock during mining. The face sampling and confirmatory sampling will be conducted on waste rock encountered during the development and mining of the Bellekeno, Flame and Moth and Birmingham deposits to support the Waste Rock Management Plan. This section provides a summary these two sampling programs.

These procedures will be tested and verified on site during the initial mine development to ensure practical and consistent classification of waste rock. The intent of this, and all, management plans is to provide clear and simple guidance for field management in addition to providing the detailed science which has informed those procedures.

4.1 WASTE ROCK SCREENING

Samples for both field screening and compositing for further geochemical and ABA confirmatory testwork are collected using the Face Sampling Method, which is used in all new mine working developments. This method ensures accurate, representative characterization of each blast round and allows field screening tests to be performed in a timely manner so that waste rock can be most efficiently treated according to the waste rock management categories.

4.2 P-AML FIELD CRITERIA

Waste rock will be classified as potentially acid generating and/or metal leaching (P-AML) or non-acid generating and/or metal leaching (N-AML) based on carbonate content from the fizz test result and visually estimated sulphide content.

The sample will be classified as P-AML if it meets the following field screening criteria:

1. Fizz test results shows no effervescence of pulverized sample with 25% HCl (e.g., presence of no bubbles, fizz rating ≤ 1), and visual estimated pyrite $>0.5\%$, or;
2. Any sample with one or more of the following:
 - a. visual estimated sphalerite $\geq 0.75\%$
 - b. visual estimated galena $\geq 0.5\%$
 - c. visual estimated pyrite $\geq 2\%$
 - d. any mineralized vein material associated to the ore vein
 - e. paste pH ≤ 6.0

4.3 FACE SAMPLING

The Face Sampling (Figure 4-1) procedure remains the same as the procedure used during Alexco's previous mine operations. In parallel, AKHM is evaluating an additional but comparable sampling technique to ensure representative and timely sampling for waste rock classification. In this procedure, as the waste rock lithology is relatively flat, vertical samples are taken on units as the units are exposed while the decline progresses. Each



sample represents the unit over the specific width measured. The entire face is mapped with descriptions of all sulphide mineralization if present.

Sample locations are recorded, and the details will be located within the 3D model.

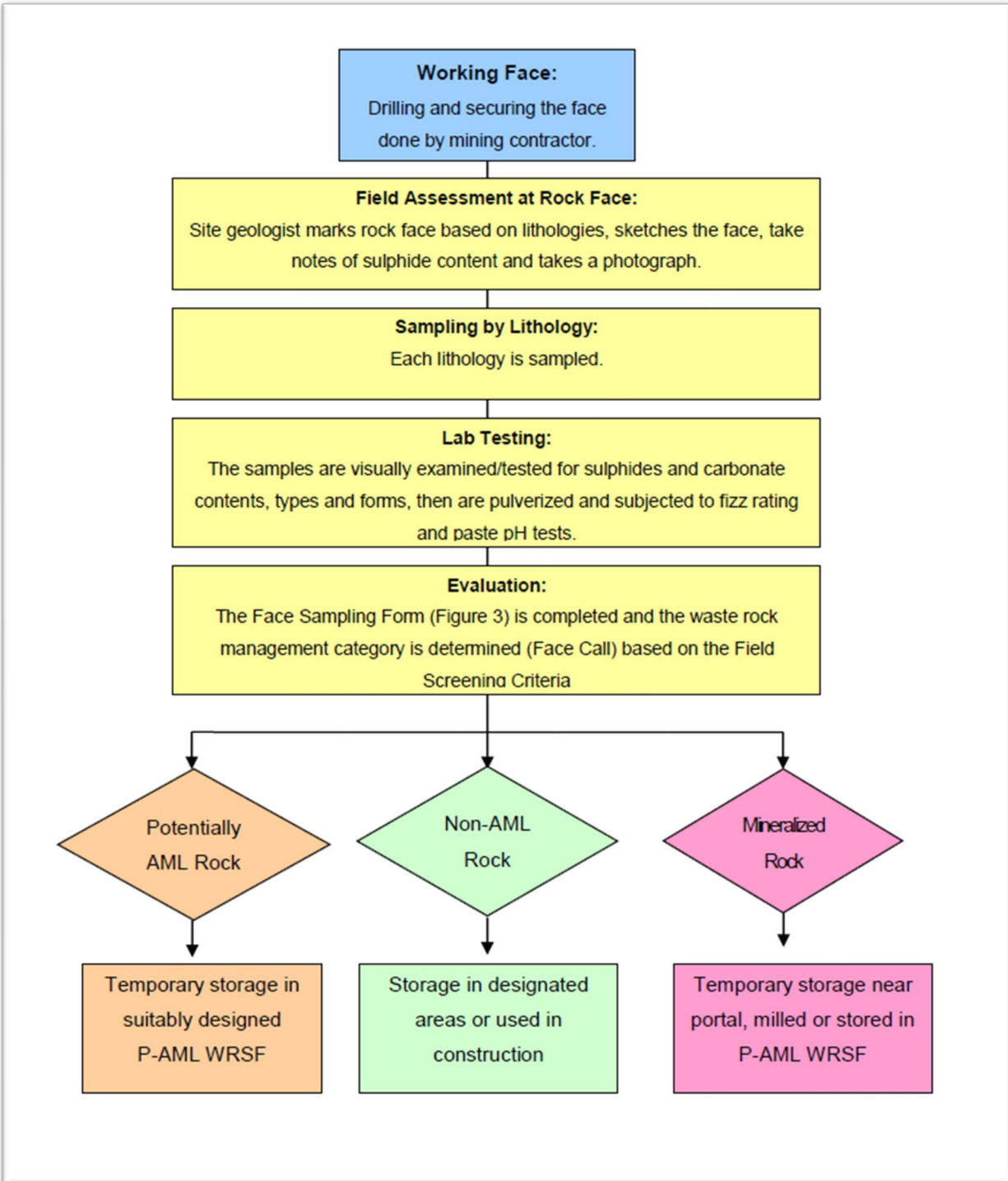

Figure 4-1: Face Sampling Method

The specific steps include:

- Mark up the heading and centre line of the development drive and define the side walls and back heights to be taken;
- Identify each lithology on the rock face and mark the boundaries between each lithology by spray paint;
- Determine where the sample will be taken from the rock face for each lithology;
- Write the sample number by spray paint for each lithology on the rock face where the sample will be taken;
- Sketch the rock face complete with the lithology information, sample number, etc. on the Face Sampling Form (Figure 4-2) and take a photograph of the rock face;
- Visually estimate sulphide and carbonate content for each lithology and record the information on the Face Sampling Form; and
- Collect sample for each lithology as rock chip samples (approximately 2 kgs). Then transfer collected samples to the field laboratory.

**ALEXCO RESOURCE CORP. KENO HILL PROJECT
 FACE SAMPLING FORM**

Mine: BK 625 Geologist: T.M / M.W. Date: 28-Oct-06

Development: SW B-PASS 625 Production: Waste Sample Type: CHIP

Face Location	Spad #	Dist. (m)	Direction	Face Dimensions	Width (m)	Height (m)	Length (m)
	<u>P27</u>	<u>7.3m</u>	<u>SW</u>		<u>2.4</u>	<u>2.4</u>	

Face Name: P27-SW-7.3m Lab Testing Visual Estimate

Sample#	Primary Lithology	Paste pH	Fizz Rating	%Pyrite	%Sphal.	%Galena	%CaCO ₃	Area(m ²)
<u>E607498</u>	<u>QZT2T</u>	<u>9.65</u>	<u>4</u>	<u>0</u>	<u>0</u>	<u>0</u>	<u>70.75</u>	<u>2.48</u>
<u>499</u>	<u>GSCH 5% QZT2T</u>	<u>9.11</u>	<u>4</u>	<u>0.25</u>	<u>0</u>	<u>0</u>	<u>70.75</u>	<u>0.80</u>
<u>500</u>	<u>QZT2T</u>	<u>9.56</u>	<u>4</u>	<u>0</u>	<u>0</u>	<u>0</u>	<u>70.75</u>	<u>3.04</u>

Notes: Fault on L.H.S. SINISTRAL OFFSET - 0.35 m. 15cm
THICK GORGE ALONG FAULT. MUD IS RND BASE
QZT2T units both have strongly developed jointsets
w/ mod-heavy limonite staining. No visible Py
on freshly broken QZT2T. Minor Py in GSCH band.

ABA Classification:
 # 1

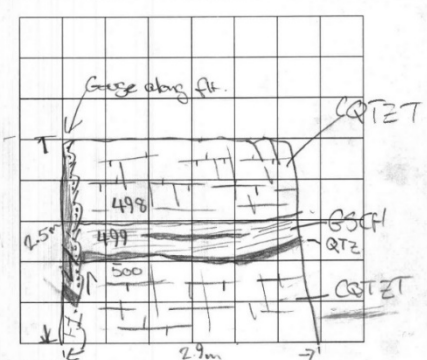

PHOTO ID: _____

Figure 4-2: Example of Face Sampling Form

4.4 ONSITE LABORATORY TESTING

In the onsite laboratory:

- Dry, crush and pulverize the waste rock samples;
- If the visual sulphide mineral information obtained from the face sampling is not sufficient to classify the waste rock samples according to screening criteria 2 in Section 2, perform the fizz and/or paste pH testing on the sub-samples of pulverized materials;
- Store the remaining pulverized samples for the future geochemical testing if needed; and
- Complete the Face Sampling Form with the testing results.

4.5 WASTE ROCK CLASSIFICATION BASED ON FIELD SCREENING

Waste rock samples will be classified as P-AML or N-AML based on the following steps:

- When sufficient information on the sulphide mineral abundance is obtained, classify the waste rock based on screening criteria 2 in Section 2. Otherwise, compare both the result of fizz testing and visual estimated pyrite content to screening criteria 1 in Section 2; and
- Complete the Face Sampling Form with the waste rock type.

4.6 CONFIRMATORY SAMPLING AND TESTING

Confirmatory sampling and geochemical testing (Acid Base Accounting and metals by ICP) will be conducted to provide additional verification of the effectiveness of the field screening criteria. The confirmatory sampling frequency and geochemical testing frequency depend on size of blast round block, workings dimensions, and N-AML/P-AML designation. An example for 3x3 m workings is presented in Table 4-1.

Table 4-1: Number of Blast Rounds for a 3x3 m Workings to Meet Confirmatory Sampling Threshold

Confirmatory Analysis	N-AML rock		Confirmatory Analysis	P-AML rock	
	2 m Blast	3 m Blast		2 m Blast	3 m Blast
ICP (1 sample/200 t)	4	2	ICP (1 sample/100 t)	3	1
ABA (1 sample/500 t)	10	2	ABA (1 sample/100 t)	7	1

The samples for confirmatory testing purpose should be a composite of chips from face, material from drilling or blasted waste rock from one or more blast round samples, weighted according to the observed face lithology. When samples are collected the rock samples collected should be less than 2 inches to facilitate transport to offsite lab and prioritize the smaller size fraction in which sulphide minerals will reside.

The composite samples will be prepared as follows:

- First, the respective tonnage from each blast round is calculated based on the area and the digitized photo of each face (example Figure 4-3).
- The total volume of each blast round will be calculated by multiplying the area with the length of each blast round.
- Then tonnage represented by each sample is calculated by multiplying the calculated volume with average density according to the lithology (e.g. quartzite density is approximately 2.7 tonnes/m³).
- The composite sample for each blast round is prepared based on the respective tonnages for each lithology.

Additional compositing will be done on these composite blast round samples if the total tonnage of waste rock from one blast round is less than total tonnage for confirmatory sampling frequency (e.g. analysis schedule 200/500 tonnes for N-AML and 100 tonnes for P-AML). The composite confirmatory samples from more than one blast round will be prepared based on respective tonnages from each blast round.

The composite confirmatory samples will be shipped to an accredited external laboratory for geochemical testing. The samples for acid base accounting will be pulverized and analysed via acid base accounting

methods, including total sulphur via Leco furnace, sulphate via HCl digestion, neutralization potential via siderite-corrected Sobek method, total inorganic carbon, and paste pH at a 1:1 solid to water ratio.

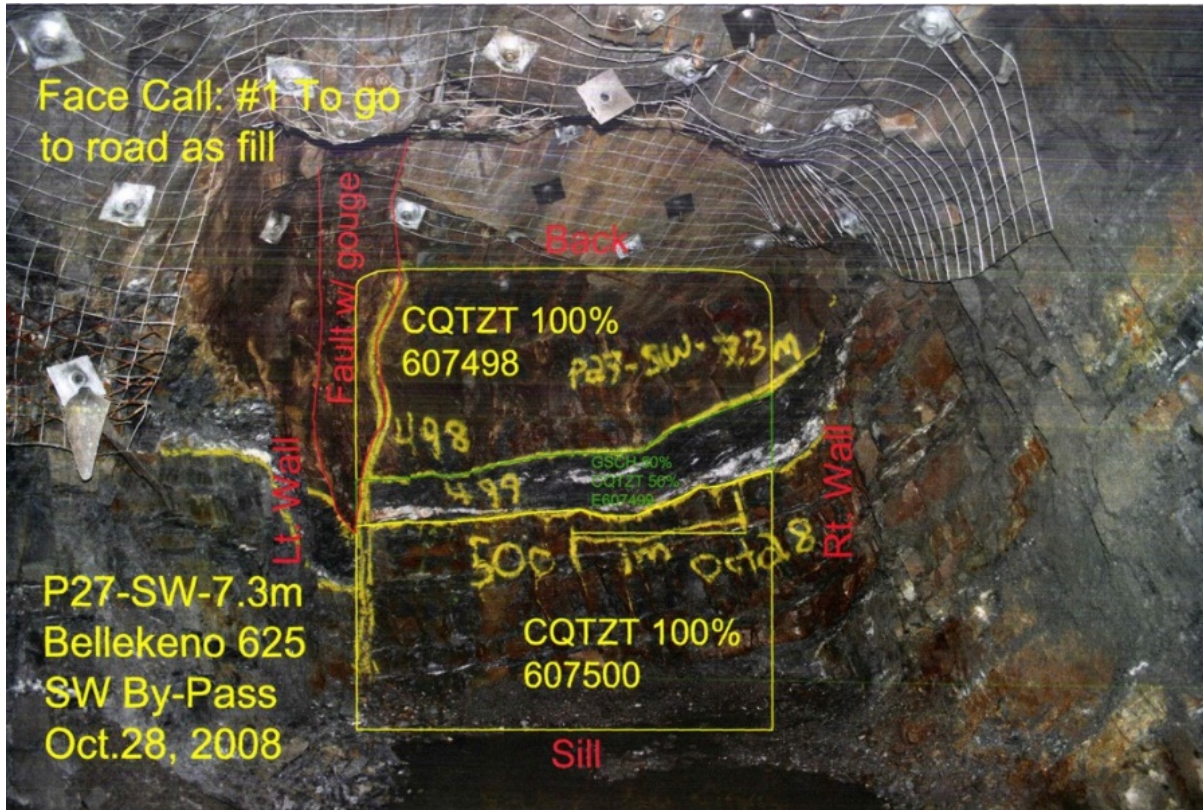

Figure 4-3: Face Photo of Bellekeno 625 Bypass Showing Sampling According to Lithology and Calculated Sample Areas

4.7 TIME LAG

4.7.1 TIME LAG BETWEEN EXCAVATION AND SAMPLING

The time between blasting and exposure of a new face to sampling and the Face Call (waste rock management category designation) for a given round shall not exceed 48 hours notwithstanding unforeseen and extenuating circumstances such as breakdown of analytical or lab equipment.

4.7.2 TIME LAG BETWEEN EXCAVATION AND RECEIPT OF ANALYTICAL DATA

The total time between excavation and receipt of analytical data is dependent on a number of factors. First, the size of the composite sample being tested can extend the length of time between excavation and receipt of data especially for individual blast rounds near the beginning of the composite sample. For example, at a rate of development of two blast rounds per week at approximately 120 tonnes per round would take two weeks to accumulate the rock required to complete a composite ABA sample of 500 tonnes. In headings of non-continuous mining this delay can extend out much further. Second, standard laboratory practices for individual analytical packages take varying amounts of time for completion (e.g., ABA analysis takes longer than ICP). In spite of these uncertainties, we are able to suggest the following limits of time lag between excavation and receipt of analytical data for ABA and ICP analysis data.

4.7.3 TIME LAG BETWEEN EXCAVATION AND RECEIPT OF ICP DATA

The time between blasting and exposure of the final face comprising the composite to receipt of ICP analytical data shall not exceed two months notwithstanding extenuating circumstances such as breakdown of lab equipment or delays at the analytical laboratory.

4.7.4 TIME LAG BETWEEN EXCAVATION AND RECEIPT OF ABA DATA

The time between blasting and exposure of the final face comprising the composite to receipt of ABA analytical data shall not exceed three months; notwithstanding extenuating circumstances such as breakdown of lab equipment, or delays at the analytical laboratory.

4.8 GEOCHEMICAL SCREENING CRITERIA

Following receipt of the ABA and ICP laboratory testing results, the waste rock will be classified based on the geochemical screening criteria in Table 4-2.

Table 4-2: Waste Rock Classification Criteria

Mine	P-AML	N-AML for Construction
Bellekeno	<ul style="list-style-type: none"> • Ca% ≤ 0.75% and S via ICP ≥ 0.25 %; or • S via ICP ≥ 1.5%; or • Pb via ICP ≥ 5000 ppm; or • Zn via ICP ≥ 5000 ppm 	<ul style="list-style-type: none"> • Any N-AML rock; • N-AML rock placed within 30 m of surface water body must have Zn < 1100 ppm
Flame and Moth For rock ≥ 5 m away from mineralized vein fault deposit	<ul style="list-style-type: none"> • S via ICP ≥ 1.5%; or • Pb via ICP ≥ 5000 ppm; or • Zn via ICP ≥ 5000 ppm 	<ul style="list-style-type: none"> • Any N-AML rock • N-AML rock placed within 30 m of surface water body must have Zn < 1100 ppm
Flame and Moth For rock within 5 m of the mineralized vein fault deposit	<ul style="list-style-type: none"> • Ca% ≤ 0.75% and S via ICP ≥ 0.25 %; or • S via ICP ≥ 1.5%; or • Pb via ICP ≥ 5000 ppm; or • Zn via ICP ≥ 5000 ppm 	<ul style="list-style-type: none"> • Flame and Moth N-AML rock can only be used for construction purposes around the District Mill site
Birmingham	<ul style="list-style-type: none"> • Ca% ≤ 0.75% and S via ICP ≥ 0.25 %; or • S via ICP ≥ 1.5%; or • Pb via ICP ≥ 5000 ppm; or • Zn via ICP ≥ 5000 ppm 	<ul style="list-style-type: none"> • N-AML rock must also have Carbonate NPR>2 • N-AML rock placed within 30 m of surface water body must have Zn < 1100 ppm

5. WASTE ROCK MONITORING

Clauses 96 and 97 of QZ18-044 require that:

96. Between May and October of each year, the Licensee must inspect monthly the Waste Rock storage facilities, as described in the WRMP and submit data as part of the annual report.
97. The Licensee must provide to the Board a summary of annual amount of Waste Rock, in tonnage that was brought to the surface and a percentage breakdown of the P-AML vs N-AML for each mine as part of the annual report.

Programs for ongoing physical and water quality surveillance of waste rock storage facilities through inspections and drainage monitoring have been established as part of the Advanced Exploration Program. Physical surveillance of waste rock storage areas will occur on a monthly basis at the following locations:

- All P-AML waste rock storage facility or equivalents; and
- All N-AML waste rock disposal areas or areas where N-AML will be used for construction including roads between Bellekeno East Portal and Bellekeno 625, roads between Bermingham and the District Mill, the 'power line road' that runs along the north slope of Sourdough Hill, the bypass road constructed along the north side of Keno City, the Bellekeno and Bermingham waste rock disposal areas, and all other locations where N-AML rock is used as fill or construction material.

In addition, Clause 13.2 of QML-0009 requires that the physical stability of all engineered structures, which includes waste rock storage facilities, must be inspected by an independent engineer by September 1 of each year.

5.1 PHYSICAL INSPECTION METHODS

The purpose of the physical inspection is to observe and record sufficient information to permit development of a course of action; repair or rehabilitation if it is required. Specifically:

- Physical stability such as settling and excessive erosion (tension cracks, bulges at the toe; on waste rock road surfaces, washouts, rutting and culvert seating);
- Evidence of permafrost degradation in any areas of physical disturbance;
- Evidence of sulphide oxidation and onset of acidic conditions or metal leaching. This type of inspection will include observation for iron staining (red-orange-yellow discolouration), white or brown colour that may indicate the presence of aluminum or manganese precipitates, the presence of salt precipitate or gypsum. Observation of snow melt areas during non snow melt period (i.e., winter) may be suggestive of marked sulphide oxidation resulting in locally elevated temperature. If seepages are observed in a suspected area, their pH will be measured and samples collected for testing; and
- Occurrence of drainage or seeps from rock storage areas. If drainage is noted, flow volume will be estimated, and basic field parameters of pH and conductivity recorded as well as sampled for metals. More detailed monitoring will be initiated as required and based on specific results if field monitoring results indicate:
 - i. pH significantly declining between measurements or dropping below 7.0, and/or
 - ii. zinc concentrations show a significant increasing trend or zinc above 0.5 mg/L.

Inspection checklists will be filled out on a monthly basis to ensure structural integrity of mine components and that runoff and discharge is being appropriately managed. The following rating system (Table 5-1) will be used in the field reporting to evaluate the structural integrity of the areas to be physically inspected:

Table 5-1: Physical Inspection Rating System

Condition Rating	Details
Excellent	“As New” Condition.
Good	System or element is sound and performing its function; although it shows signs of use and may require some minor repairs, mostly routine.
Fair	System or element is still performing adequately at this time, but needs “priority” and/or “routine” repair to prevent future deterioration and to restore it to good condition. A fair rating will be reported to site manager after the inspection.
Poor	System or element cannot be relied upon to continue to perform its original function without “immediate” and/or “priority” repairs. A poor rating will be reported to site manager after the inspection.

If issues are identified during the monthly inspections of waste rock storage areas, the site manager will be informed immediately and the appropriate mitigative measures will be implemented. An inspection by a qualified geotechnical engineer would be undertaken for physical stability if necessary. Additional erosion and sediment controls may need to be implemented as required. Appropriate mitigative measures will be implemented should acidic or metal rich drainage be detected in order to prevent adverse impacts to receiving waters.

If geotechnical inspections are required, they will be carried out during the summer months when the surface and sides of the various rock-fill structures are not obscured by snow.

The lined P-AML storage pad areas will be monitored for drainage volume with field parameters (pH and conductivity, temperature) measured on a monthly basis from May to October. Providing there is sufficient water accumulation, samples will be collected and a full suite of water quality analyses conducted at least twice per year. The sumps will be monitored monthly using a Heron Instruments Dipper-T probe to determine the volume of any water accumulated within the storage facility. Periodically, water will be directed to licenced water treatment and discharge facilities for discharge or treatment prior to discharge if required. Water from any additional P-AML waste rock storage facilities will be treated in the same way. Upon closure, these facilities will be removed as they are all temporary and will not require ongoing maintenance.

5.2 WASTE ROCK CLASSIFICATION RECORD

As mentioned in Section 7 the amount of N-AML and P-AML waste rock that will be deposited at WRSF as well as amount-N-AML will be utilized for construction work will be recorded and reported in the Annual Report.

5.3 KINETIC TESTING OF WASTE ROCK

Clause 43 of QZ18-044 requires that:

Within 90 days of the effective date of this License, the Licensee must submit to the Board an update to exhibit 1.5.3, WMRP. The updated plan must include:

- a) updated results of testing completed to-date and plans for further kinetic testing of N-AML and P-AML Waste Rock for New Birmingham, Bellekeno, and Flame & Moth Mines;*
- b) the plan for saturated column testing for backfill material for New Birmingham, Bellekeno, and Flame & Moth Mines. The material selected for the saturated columns should be representative of the backfill at each site, which may include P-AML and N-AML waste rock, tailings, and cement;*
- c) kinetic testing for brine cements, if brines are produced by water treatment plants; and*
- d) storage facilities required for waste rock amounts permitted under Clause 21 of this Licence.*

This section describes kinetic testing to be implemented as part of the WRMP. The results of kinetic testing of waste rock completed to date are provided in Appendix A.

5.3.1 KINETIC TESTING OF N-AML WASTE ROCK

Within 3 months of resumption of commercial production, Alexco commits to initiation of kinetic testing of representative samples of N-AML resulting from excavation of Bellekeno, Flame & Moth, and Birmingham, Mines. This kinetic testing may include the use of laboratory humidity cells, field bins, or field lysimeters. Alexco commits to conducting kinetic testing on a per-tonnage basis of a minimum of one kinetic sample per 40,000 tonnes of N-AML excavated rock destined for disposal or usage on surface. Such data will complement the existing dataset, which comprises:

- Flame & Moth N-AML waste rock humidity cell (completed – 98 weeks);
- Two Birmingham N-AML waste rock humidity cell: The first humidity cell was initiated in September 2017 and terminated in October 2018 after 57 weeks of operation and the second humidity cell was initiated in February 2019 and currently ongoing (67 weeks of data are available and reported in Appendix A); and
- Three ongoing field barrels filled with Flame & Moth N-AML drill core (ongoing - initiated in spring 2013).

5.3.2 KINETIC TESTING OF P-AML WASTE ROCK

For temporary storage of P-AML waste rock on surface, Alexco utilizes lined waste rock P-AML WRSFs according to an approved typical design (Section 2.2). Water quality representing accumulated meteoric water combined with pore water within these facilities (e.g. KV-78b KV-106, KV-115, and KV-119) are required by the water licence to be monitored monthly between May and October for field parameters including pH, temperature, conductivity, and water level within the facility. A more detailed external laboratory suite is required quarterly, and includes total and dissolved ICP metals, phosphorus, sulphate, dissolved organic carbon, alkalinity, pH, conductivity, total suspended solids, and hardness. Water samples have been collected from the Bellekeno P-AML WRSF and one field barrel with Flame & Moth P-AML drill core is ongoing. The Birmingham P-AML WRSF will also be monitored at proposed stations KV-115 and KV-119.

Humidity cell testing will be initiated for P-AML waste rock from Bellekeno, Flame & Moth, and New Birmingham with the main objective to assess acid onset time of the P-AML waste rock from these mines.

5.3.3 SATURATED COLUMN TESTING OF BACKFILL MATERIAL

Excavated stopes at each developed mine will be backfilled. Backfill material will consist of development waste rock (N-AML and P-AML), dry filtered tailings, and cement. The mix of these materials will be varied to optimize the most efficient and cost effective back filling sequence. However, the first priority use of backfill material will be P-AML waste rock. Approximately 3% to 5% of cement by weight will be mixed with the backfill material. The saturated column testing will be conducted on the backfill material to assess the acid and metal leaching from the backfill materials that will be deposited below the flood elevation at the underground mines. The saturated column testing will be initiated for representative materials used as backfill for each mine (Bellekeno, Flame & Moth, and New Birmingham) that include cemented N-AML waste rock, the cemented P-AML waste rock, the cemented N-AML waste rock with tailings, and the cemented P-AML waste rock with tailings.

5.4 USE OF N-AML ROCK FOR CONSTRUCTION PURPOSES

5.4.1 FLAME & MOTH

Clause 21 of QZ18-44 requires that N-AML waste rock from the Flame & Moth mine will only be used for construction purposes within the KHSD Mill Site. The KHSD Mill Site is defined in QZ18-044 as:

"Keno Hill Silver District Mill Site" means the area of mineral claims identified in Schedule A1 of this licence which process New Birmingham, Bellekeno, and Flame & Moth ore, disposing of resulting tailings, and disposing of treatment sludge from the Flame & Moth and Keno Hill Silver District Mill water treatment plants."

Only N-AML waste rock with Zn < 1,100 ppm will be used for construction within 30 m of surface water bodies and waste rock with higher zinc content will be used in other areas around the KHSD site.

5.4.2 BIRMINGHAM

As described in Section 3, Birmingham waste rock for construction purposes must be both N-AML based on the Bellekeno screening criteria and have a carbonate NPR > 2. The carbonate NPR is calculated based on a carbonate NP calculated from total inorganic carbon analyses of the rock composite sample. This provides additional conservatism to ensure that only non-acid generating waste rock is diverted for construction.

Only N-AML waste rock with carbonate NPR > 2 will be earmarked for construction: N-AML waste rock with carbonate NPR > 2 and Zn < 1,100 ppm will be used for construction within 30 m of surface water bodies and waste rock with carbonate NPR > 2 and higher zinc content will be used in other areas.

6. ADAPTIVE MANAGEMENT

In addition to measures described above, an Adaptive Management Plan (AMP) (Ensero, 2020) has been prepared for the entire development. As a requirement of Type A Water Licence QZ18-044, Alexco has written an AMP specific to the Bellekeno, Flame & Moth, and Bermingham undertakings.

7. REPORTING

Documentation of waste rock management activities including operational field screening, segregation, handling, management and ongoing geochemical monitoring and analyses will be compiled and included in the annual mining land use, Quartz Mining License and Water Licence annual reports. Water Licence QZ18-044 deliverables will meet the requirements set out in Clauses 121 and 122:

121. The Licensee shall provide to the Board one unbound, single-sided, paper copy of all deliverables required by this Licence. All deliverables, with the exception of design drawings, must be reproducible by standard photocopier.
122. The Licensee must upload electronic copies of all deliverables required by this Licence to the Yukon Water Board's online licensing registry. Electronic copies must be submitted in one of the following formats: MS Word, MS Excel, or Adobe .pdf format. Water quality results must be in the format outlined in the "Laboratory Data Submission Standards for Water Quality", as amended from time to time and available on the Board website.

In addition, QML-0009 Clause 13.3 requires that the results of the independent engineer's annual review of the physical stability of all engineered structures, works and installations, which includes the waste rock storage facilities, be reported within 90 days of inspection:

13.3 Within ninety (90) days of the inspection referred to in paragraph 13.2, the Licensee must submit to the Director and the Inspector a written report prepared by the engineer that conducted the annual inspection documenting the results of the inspection, including a

- a) summary of the stability, integrity and status of all of the inspected structures, works, and installations; and
- b) any recommendations for remedial actions made as a result of the investigations and evaluations.



8. CLOSURE AND RECLAMATION

Reclamation and closure of P-AML waste rock storage facilities and N-AML waste rock disposal areas are discussed in the Reclamation and Closure Plan. As part of Closure and Reclamation studies, kinetic testing of N-AML and P-AML for Flame & Moth rock was initiated in 2013. Kinetic testing of Birmingham N-AML waste rock was initiated in 2018 and is ongoing. Further kinetic testing will be undertaken as the mining operations in the KHSD are resumed, which will look at the acid generation and metal leaching potential of the waste rock units that will be brought to surface through humidity cells, saturated columns, or field bins. All P-AML waste rock will be backfilled underground below the static water level as part of the reclamation plan.

9. REFERENCES

- Alexco Environmental Group (AEG) (2019a) *Birmingham Waste Rock Static Geochemical Characterization Report* prepared for Alexco Keno Hill Mining Corp. April 2019.
- Alexco Environmental Group (AEG) (2019b) *Type A Water License QZ09-092 Renewal Application QZ18-044. Keno Hill Silver District Mining Operations*. Report prepared for Alexco Keno Hill Mining Corp. April 2019.
- Alexco Environmental Group (AEG) (2018a) *AKHM Waste Rock ARD/ML Characterization Update. Memorandum* prepared for Alexco Keno Hill Mining Corp. December 2018.
- Alexco Environmental Group (AEG) (2018b) *Adaptive Management Plan Keno Hill Silver District Mining Operations*. Report prepared for Alexco Keno Hill Mining Corp. July 2018.
- Alexco Environmental Group (AEG) (2016). *Geochemical Rock Characterization, Flame & Moth Project, Keno Hill District, Yukon*. Report prepared for Alexco Keno Hill Mining Corp. March 2016.
- Altura Environmental Consulting (2008a). *Review of Historic Keno Static Test Data to Define ARD/ML – Controlling and Correlating Factors. Letter*, Report prepared for Access Consulting Group, January 4, 2008.
- Altura Environmental Consulting (2008b). *Geoenvironmental Rock Characterization, Bellekeno Zone. Letter* report prepared for Access Consulting Group, January 8, 2008.
- CRC (2005) *Handbook of Chemistry and Physics, 85th Edition*. CRC Press. Boca Raton, Florida.
- EBA (2008). *Typical Waste Containment Facility Design, Keno Hill Silver District, YT Construction Specifications Issued for Use*. Report prepared for Alexco Resource Corp., submitted as part of the application for Water Licence QZ09-092.
- EBA (2009). *Review of Potential Site for Typical Waste Rock Containment Facility, Bellekeno East Adit, Keno Hill Silver District, YT. Issued for Use*, Report prepared for Alexco Resource Corp., July 30, 2009.
- EBA (2010). *Response to Water Board Questions – Bellekeno Waste Rock Dump. Issued for Use*, Report prepared for Alexco Resource Corp., April 1, 2010.
- EBA (2014). *Waste Storage Facility Design – Revision 1, Flame & Moth Property, Keno City, Yukon. Issued for Use*, Report prepared for Alexco Resource Corp., October 2, 2014.
- Price, W.A. (2009) *Prediction Manual for Drainage Chemistry from Sulphidic Geologic Materials. MEND Report 1.20.1*. CANMET – Mining and Mineral Science Laboratories, Smithers, BC.
- Tetra Tech Inc. (2017) *Preliminary Design for Waste Rock and P-AML Storage Birmingham Property, Keno Hill Silver District, Yukon*

APPENDIX A

AKHM WASTE ROCK ARD/ML CHARACTERIZATION UPDATE 5 – SEPTEMBER 2021

Memorandum

To: Linda Broughton, Alexco Resource Corp.

From: Cheibany Ould Elemine and Andrew Gault, Ensero Solutions Canada, Inc.

Date: September 22, 2021

Re: AKHM Waste Rock ARD/ML Characterization Update 5 – September 2021

1 INTRODUCTION

Acid rock drainage and metal leaching (ARD/ML) characterization of waste rock produced from prospective production areas in the Keno Hill District (KHSD) has been ongoing since Alexco Keno Hill Mining Corp. (AKHM) initiated exploration in 2006. This dataset includes static (e.g., acid base accounting, elemental metals, shake flask leach test) and kinetic (e.g., humidity cells and field barrels) of material from the following areas:

- Bellekeno;
- Onek;
- Lucky Queen;
- Flame & Moth;
- Silver King; and
- Bermingham.

This memorandum summarizes the waste rock static and kinetic data collected by AKHM to date. More detailed reporting can be found in the source documentation cited throughout.

2 REGIONAL AND DISTRICT GEOLOGY

The KHSD is primarily composed of Yukon Group metasedimentary rocks which are described in the Keno Hill Silver District Environmental Conditions Report (AEG, 2016a) and the NI43-101 technical report for the Birmingham Exploration Project (Roscoe Postle and Associates Inc., 2017). The mineralization of the KHSD is hosted within the Mississippian Keno Hill Quartzite Formation in the Tombstone Thrust Sheet, which conformably overlies the Devonian Earn Group to the north and is structurally overlain by the Upper Proterozoic Hyland Group Yusezyu Formation across the Robert Service Thrust Fault in the south (Roscoe Postle and Associates Inc., 2017).

The stratigraphic units in the district are mainly composed of the Earn Group and the Keno Hill Quartzite. The Earn Group comprises typically phyllitic, grey graphitic metasediments with an upper band of greenish chlorite-sericite meta-felsic volcanics, and minor interbedded quartzite proximal to the conformable transition to the overlying Keno Hill Basal Quartzite Member. The Keno Hill Quartzite is structurally approximately 1,900 m thick and contains the lower massive blocky Basal Quartzite Member (approximate structural thickness of 1,100 m) with thin to thick quartzite and graphitic schist interbeds and the Sourdough Hill Member (~800 m) with basal horizons of sericitic meta-rhyolite and graphitic schist, intermediate units of an Upper Quartzite, quartz eye grits, and chloritic schist that enter an overlying carbonate rich section containing well-defined black limestone beds. Mid-Triassic greenstone lenses up to 100 m thick are also contained within the Keno Hill sequence but only to the top of the Basal Quartzite Member (Roscoe Postle and Associates Inc., 2017).

One to two phases of deformation and chloritic grade regional metamorphism and isoclinal folding produced overturned isoclinal folds in the Keno Hill Quartzite Basal Member overlying the Earn Group. The mineralization was developed in northeast striking, southeasterly dipping normal oblique normal faults with displacement of tens to hundreds of metres formed likely during the early stages of deformation.

The KHSD mineralization is in the form of silver-rich base metal quartz-carbonate veins that are predominantly present in steep southeasterly dipping vein-filled faults with deposits hosted by thick competent Basal Quartzite of the Keno Hill Quartzite or occasionally where greenstone forms part of the Earn Group wall rock (Roscoe Postle and Associates Inc., 2017).

A brief descriptive overview of the major lithology types is summarized below from Boyle (1962), Altura (2008) and (Roscoe Postle and Associates Inc., 2017).

- Quartzite (QTZT): The dominant lithology unit at the Birmingham deposit development rock and occurs both as thickly and thinly bedded sequences with assemblages of graphitic schist. The quartzites are variably silicified with purer quartzites a few metres thick and darker grey, impure quartzites on to four metres thick. Quartzites are comprised primarily of quartz but also contain some mica, carbonate minerals and carbonaceous materials. Accessory minerals include leucoxene, tourmaline, zircon, apatite and pyrite. Calcareous quartzite (CQTZT) contains disseminated primary calcite that fizzes readily when subjected to dilute hydrochloric acid.
- Schist (SCH): The schist within the Birmingham development area are most commonly graphitic schist (GSCH), which are black or dark grey in color due to their significant carbon content, occur in beds from millimetre to many meters in scale, and can be intercalated with quartzites as well as the other

lithologies. In addition to graphite; quartz, mica, carbonates, feldspar, chlorite, isotropic colloidal material and pyrite metacrysts have been identified in thin sections within these rocks. Although not anticipated to be present in significant quantities in the Bermingham development (i.e., <5%), other forms of schist are documented elsewhere in the KHSD. These include quartz sericite schist (SSCH) and chlorite schists (CHSCH), which are pale to dark green in colour. Thin sections of sericite schists show primarily quartz and sericite composition, with trace carbonate minerals and leucoxene. Accessory minerals include apatite, zircon, tourmaline and pyrite metacrysts. Calcareous schist (CSCH) contains disseminated primary calcite that fizzes readily when subjected to dilute hydrochloric acid (HCl). Interbedded carbonaceous quartzite and schist (ICQS) and thin bedded quartzite (TQTZT), the latter of which does occur in the Bermingham development area, are also included as their own lithologies, but these units are predominantly composed of schist.

- Greenstone (GNST): Greenstones vary from narrow (0.3 – 2 m wide) to 100 m thick and vary in color from greyish green to dark green. Greenstones occur in conformable elongated lenses and sills as a result of boudinage, particularly within the more ductile schist units. Greenstones units are generally more resistant than the quartzites and schists and appear geomorphologically as the prominent hills in the KHSD. Thin sections show significant variety in mineral composition and texture but generally show a high degree of alteration. The primary mineralogy of the greenstones includes hornblende, actinolite, saussurite (zoisite, epidote, albite, sericite, carbonate), plagioclase (oligoclase to andesine), chlorite, stilpnomelane, biotite, sericite, leucoxene, and carbonate minerals. Quartz, K-feldspar, ilmenite, magnetite, limonite and apatite are minor constituents with some pyrite. Chlorite is also generally present, which is primarily responsible for this rock's color.

3 DATA SOURCES

The data presented in this summary memorandum are primarily sourced from AKHM's growing database of ARD/ML static and kinetic testing of waste rock samples generated from exploration of deposits of interest in the KHSD. These largely comprise waste rock from:

- Bellekeno;
- Lucky Queen;
- Onek;
- Flame & Moth;
- Silver King; and
- Bermingham.

3.1 STATIC TESTING

Static testing of these materials has typically consisted of:

- Acid base accounting (ABA) analyses, including:
 - Paste pH;
 - Siderite-corrected neutralization potential (NP) using the method of Skousen et al. (1997);
 - Total sulphur by Leco;
 - Sulphate sulphur by HCl extraction;
 - Sulphide sulphur by difference, used to calculate acid potential (AP); and
 - Total inorganic carbon (TIC) by HCl leaching.
- Bulk elemental analysis by aqua regia digestion and ICP-MS analysis of digestate; and
- Shake flask extraction (MEND SFE) to determine soluble constituents associated with these materials (Price 2009).

3.2 KINETIC TESTING

Kinetic testing has largely comprised of laboratory-based humidity cells and site-based field leach barrels. Humidity cells tests have all been conducted for the following materials:

- Flame & Moth non-acid generating/metal leaching (N-AML) waste rock composite (98 weeks, completed);
- Birmingham N-AML cover hole waste rock composite HC-01 (57 weeks, completed); and
- Birmingham N-AML advance exploration hole waste rock composite HC-03 (107 weeks, completed).

Five field barrels have also been in operation at the KHSD site since June 2013 and comprise Flame & Moth waste rock drill core (280 to 340 kg) in barrels that are open to atmospheric weathering conditions. The field leach barrels contain a range of N-AML and potentially acid generating/metal leaching (P-AML) waste rock. Precipitation that percolates through the barrels is collected in pails that are sampled on a monthly basis during the ice-free months.

4 STATIC TESTING DATA

ARD/ML data of waste rock samples collected from exploration drill core at prospective production zones shown in Figure 4-1 within the KHSD were compiled. These included the:

- Bellekeno (Altura, 2008);
- Onek (ACG, 2011a);
- Lucky Queen (ACG, 2011b);
- Silver King (ACG, 2011c);
- Flame & Moth (AEG, 2016b); and
- Birmingham zones (AEG, 2018).

The lithological distribution of samples in each production zone is presented in Table 4-1.

Table 4-1: AKHM Prospective KHSD Production Zones Sample Lithologies Sampled for ARD/ML Characterization

Production Zone	Lithology (Number of Samples)									Total
	GNST	GSCH	QTZT	SSCH	TQTZT	ICQS	CQTZTZ	CHSCH	CSCH	
Bellekeno	12	13	12	11	0	0	12	1	0	61
Onek	4	14	17	8	0	0	0	1	0	44
Lucky Queen	0	2	13	0	9	0	0	0	0	24
Silver King	1	2	7	3	7	4	0	0	0	24
Flame & Moth	1	5	28	6	7	0	2	0	1	50
Birmingham ^a	3	26	97	1	51	0	0	0	0	178
Total	21	62	174	29	74	4	14	2	1	381

^a Three fault samples collected from Birmingham not included

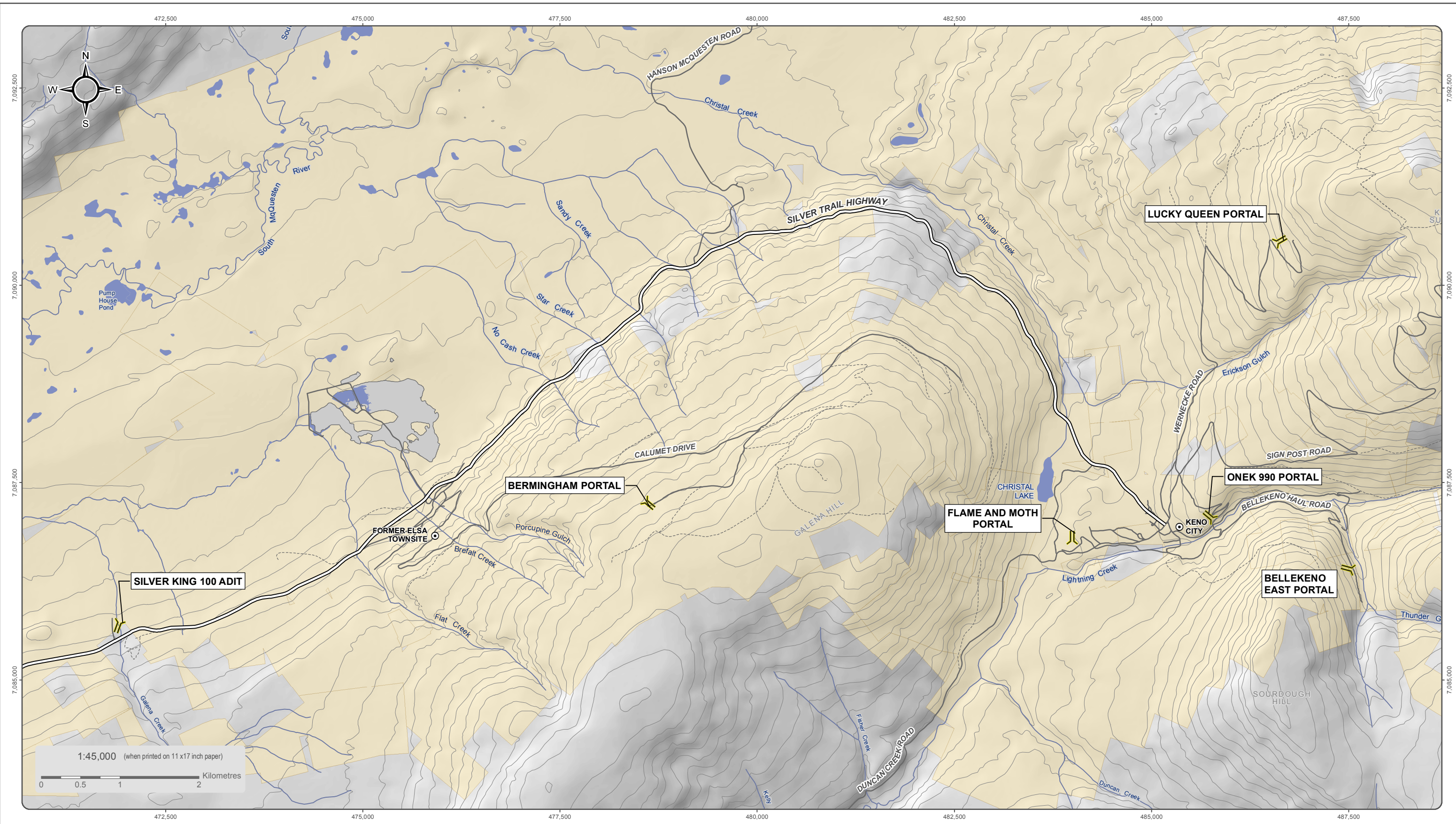









National Topographic Data Base (NTDB) compiled by Natural Resources Canada at a scale of 1:50,000. Cadastral data compiled by Natural Resources Canada. Reproduced under license from Her Majesty the Queen in Right of Canada, Department of Natural Resources Canada. All rights reserved.

Satellite imagery obtained from Yukon Geomatics map service <http://mapservices.gov.yk.ca/ArcGIS/services> on September 2017

Datum: NAD 83; Map Projection: UTM Zone 8N

This drawing has been prepared for the use of Alexco Environmental Group Inc.'s client and may not be used, reproduced or relied upon by third parties, except as agreed by Alexco Environmental Group Inc. and its client, as required by law or for use of governmental reviewing agencies. Alexco Environmental Group Inc. accepts no responsibility, and denies any liability whatsoever, to any party that modifies this drawing without Alexco Environmental

-  Place of Interest
-  Adit
-  Valley Tailings
-  Alexco/ERDC Quartz Claims
-  Waterbody
-  Watercourse
-  Silver Trail Highway
-  Other Road
-  Limited-Use Road

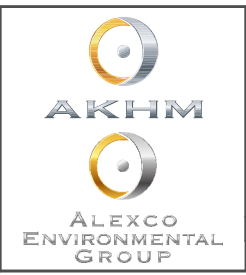

ALEXCO KENO HILL MINING CORP.

FIGURE 4-1
LOCATIONS OF WASTE ROCK ARD/ML STUDIES TO
SUPPORT ALEXCO KHSD DEVELOPMENT

SEPTEMBER 2017

D:\Project\AllProjects\ALEX-05-01\GIS\Map\Overview_Maps\Property_Overview\Alexco_Proposal_Deposits_Overview_20170914.mxd
(Last edited by: amate@alexco; 15/09/2017 12:55 PM)

4.1.1 Acid Base Accounting

The purpose of ABA is to quantify the content and ratio of potentially acid producing and potentially acid consuming minerals in each sample. This provides an indication of the acid generation potential of geologic materials.

Plots of NP versus AP, which provide an overview of the potential for net acid generation, are displayed for all the KHSD production units waste rock samples in Figure 4-2, and broken out by lithology in Figure 4-3 to Figure 4-7. In general, three categories of potential acid generation can be defined based on the NP/AP ratio (or neutralization potential ratio; NPR) of a sample (Price, 2009):

- NPR < 1 samples are classified as potentially acid generating (PAG);
- $1 \leq \text{NPR} \leq 2$ samples are capable of acid generation but with some uncertainty; and
- NPR > 2 samples are considered not potentially acid generating (non-PAG).

In general, the majority of waste rock samples collected from potential production zones across the KHSD are non-PAG (i.e., NPR > 2; Figure 4-2). Samples from Silver King had the highest proportion that were PAG (i.e., NPR < 1; 68%), largely due to their low NP content (Figure 4-2). Twenty-nine percent (29%) of the samples collected from Birmingham were also PAG and 23% fell in the uncertain category largely due to low NP and AP. Onek also had a handful of samples that were PAG (16%); however, these generally had high AP and NP. The majority of the Lucky Queen, Onek, Flame & Moth, Birmingham, and Bellekeno waste rock samples were non-PAG (58%, 73%, 74%, 48%, and 87% of samples, respectively). Overall, the waste rock from the easternmost deposits (e.g., Bellekeno, Onek, and Flame & Moth) tended to have higher NP than that found in samples from the deposits located in the western portion of the KHSD (i.e., Silver King and Birmingham).

Broken down by major lithology, the QTZT, TQTZT, and GSCH samples broadly reflected the general NPR sample distribution (11% to 31% PAG samples; 44% to 76% non-PAG; Figure 4-3 to Figure 4-5), consistent with the numerical dominance of these lithologies. The GNST and SSCH samples are predominantly non-PAG (Figure 4-6 and Figure 4-7).

4.1.2 Bulk Elemental Chemistry

Bulk concentrations of antimony, arsenic, selenium, silver, cadmium, and zinc often exceed their respective average crustal abundance by an order of magnitude (CRC, 2005) in waste rock from the KHSD. Also, elevated lead concentration is notable in a few rock samples from all deposits except Lucky Queen and Flame & Moth. Although the bulk concentration of an element does not offer a direct measure of how mobile an element may be during weathering, it can provide a preliminary indication of constituents that should be monitored for high solubility in subsequent leach and/or kinetic test. The concentrations of these elements in waste rock (as accessed by aqua regia digestion) from the Birmingham, Bellekeno, Onek, Lucky Queen, Silver King, and Flame & Moth deposit areas are displayed in Figure 4-8.

Bulk antimony and silver concentrations were higher than their respective 10x crustal abundance (2 and 0.85 ppm, respectively) for the majority of waste rock samples from Birmingham, Bellekeno, Onek, Lucky Queen, and Silver King. Lower concentrations were observed for Flame & Moth waste rock. Bulk selenium

concentrations were elevated (>10x crustal abundance; 0.5 ppm) in the majority of Birmingham and Flame & Moth samples and exhibited similar distributions. Poor detection limits (10 ppm) prevented interpretation of the Lucky Queen and Silver King selenium dataset, while selenium was not analyzed in the aqua regia digests of Bellekeno or Onek waste rock.

The highest arsenic, cadmium, and zinc concentrations were observed in waste rock from Onek, Birmingham and Bellekeno. The lowest concentrations of these metal(oids), in addition to silver and lead, were returned by Flame & Moth waste rock, which were consistently lower than the crustal abundance for all three elements.

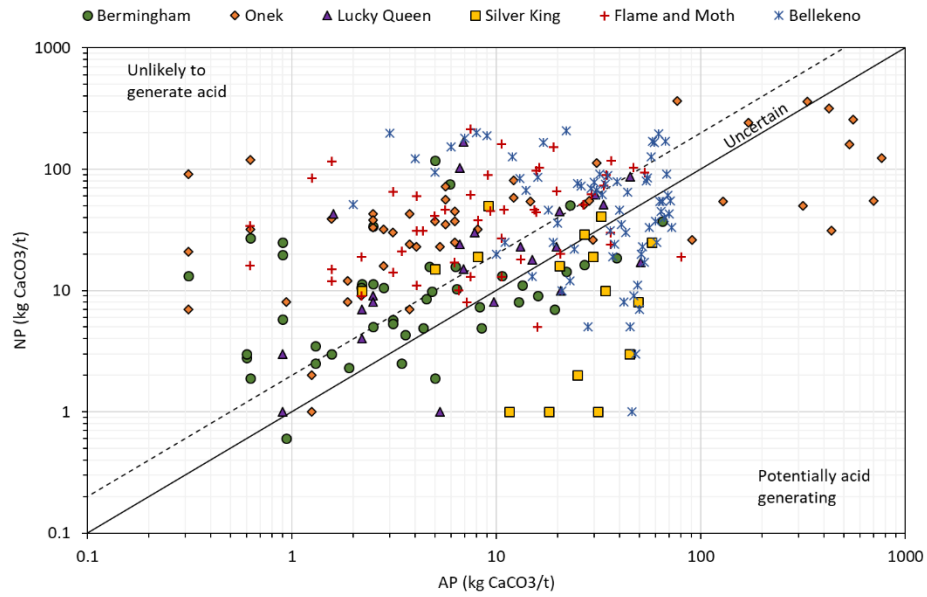

Solid and dashed lines indicate $NPR = 1$ and $NPR = 2$, respectively.

Figure 4-2: Variability in NP and AP of Waste Rock Samples from KHSO Deposits

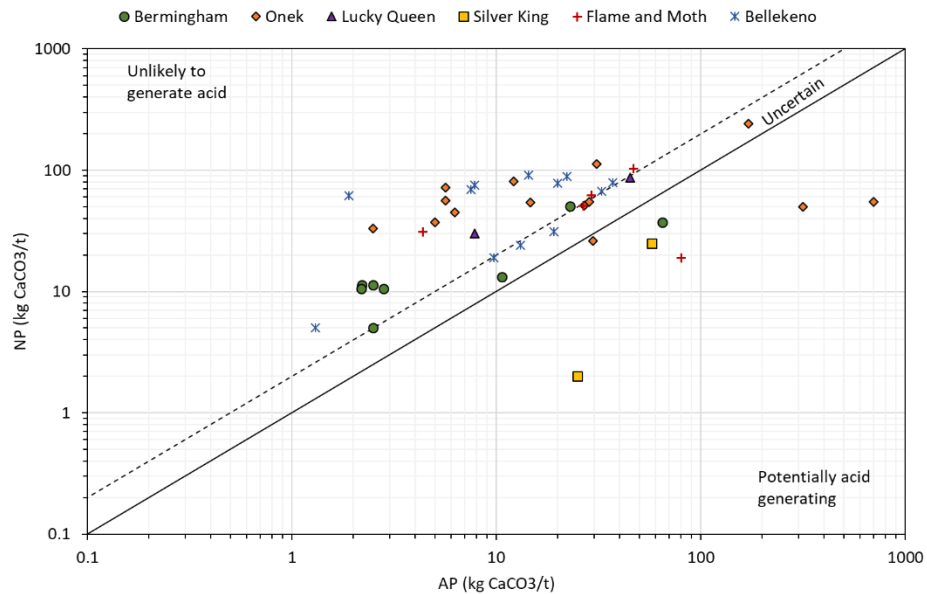

Solid and dashed lines indicate $NPR = 1$ and $NPR = 2$, respectively.

Figure 4-3: Variability in NP and AP of GSCH Lithology Waste Rock Samples from KHSO Deposits

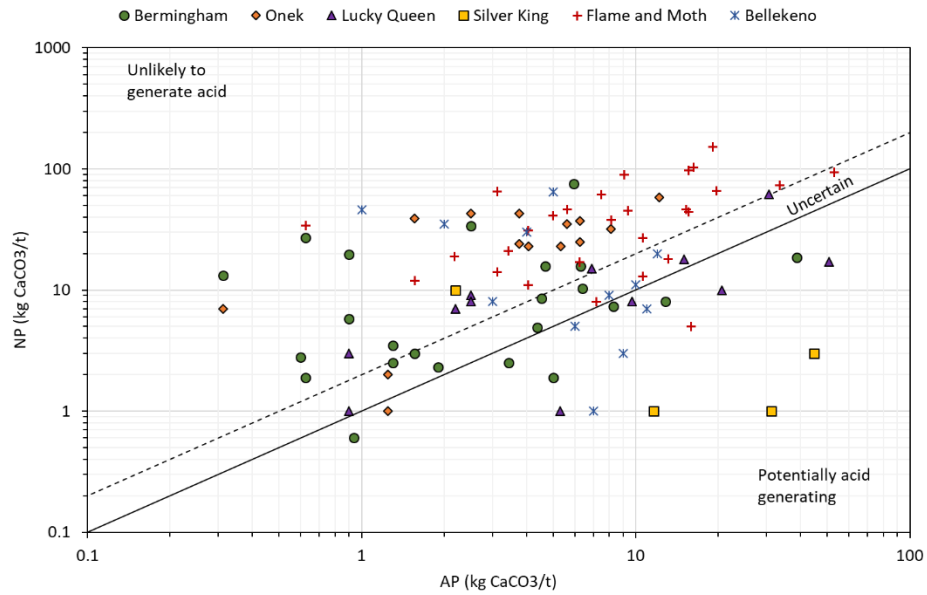

Solid and dashed lines indicate $NPR = 1$ and $NPR = 2$, respectively.

Figure 4-4: Variability in NP and AP of QTZT Lithology Waste Rock Samples from KHSD Deposits

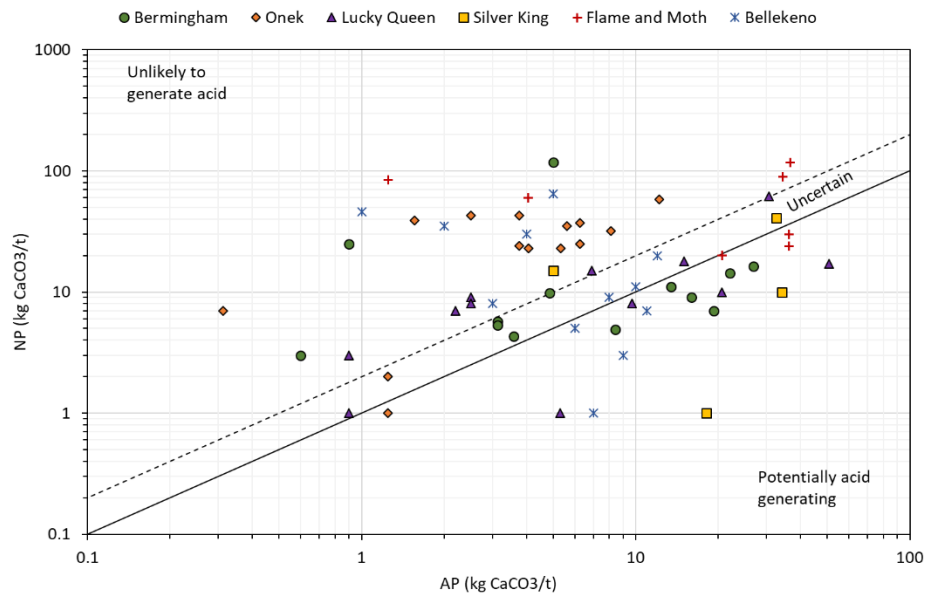

Solid and dashed lines indicate $NPR = 1$ and $NPR = 2$, respectively.

Figure 4-5: Variability in NP and AP of TQTZT Lithology Waste Rock Samples from KHSD Deposits

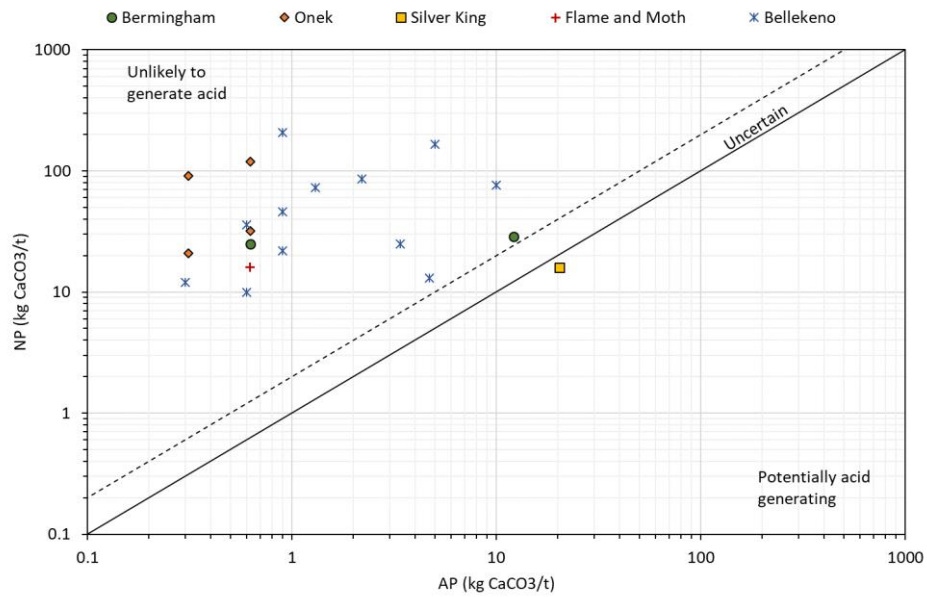

Solid and dashed lines indicate $NPR = 1$ and $NPR = 2$, respectively.

Figure 4-6: Variability in NP and AP of GNST Lithology Waste Rock Samples from KHSD Deposits

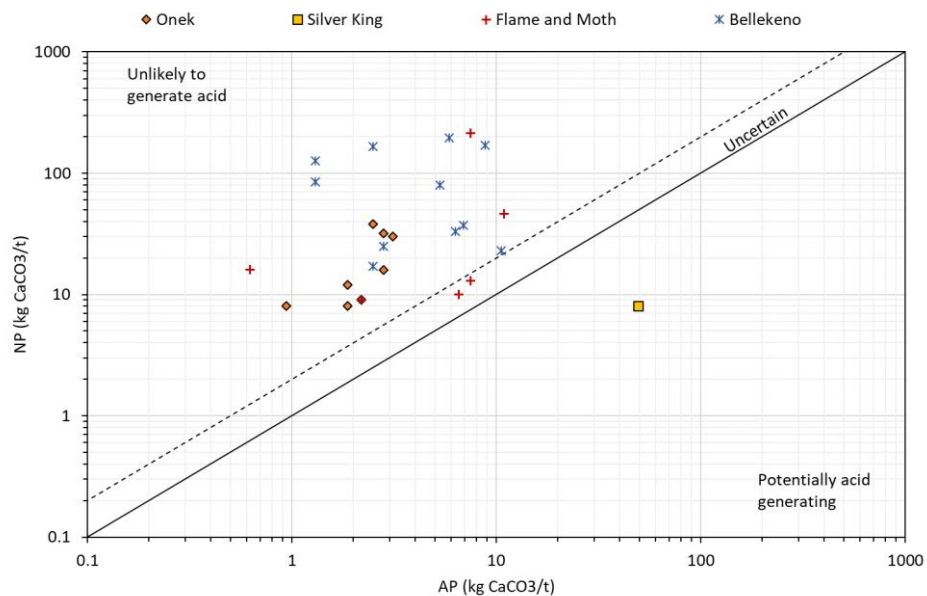

Solid and dashed lines indicate $NPR = 1$ and $NPR = 2$, respectively.

Figure 4-7: Variability in NP and AP of SSCH Lithology Waste Rock Samples from KHSD Deposits

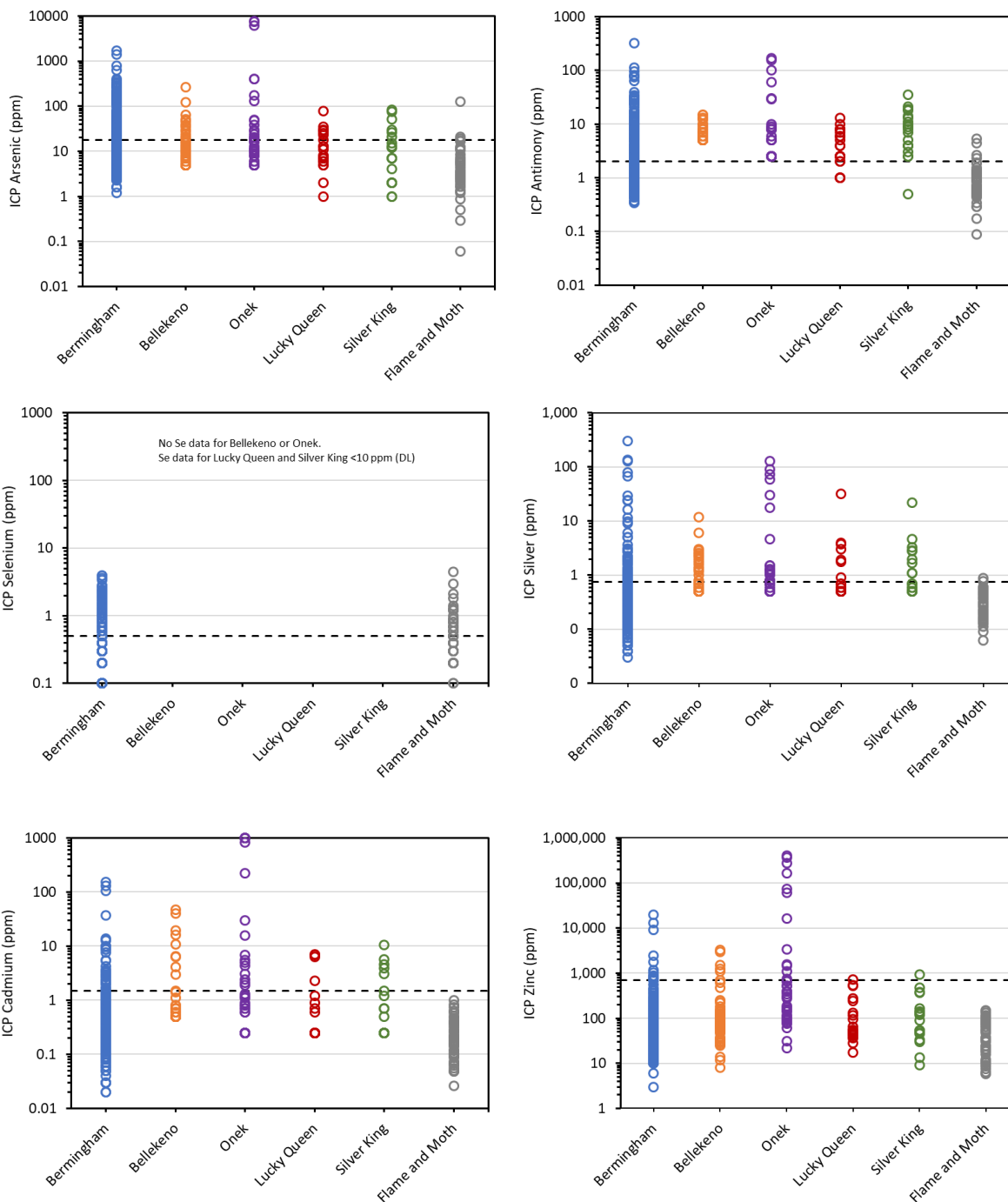

Dashed line represents 10x crustal abundance

Figure 4-8: Distributions of Bulk Concentrations of Antimony, Arsenic, Selenium, Silver, Cadmium, and Zinc by Deposit

4.1.3 Shake Flask Extraction

SFE provides a measure of the soluble metals in the sample that may be mobilized in the short term upon leaching processes. A summary of SFE leach tests carried out on samples from the main lithologies at Flame & Moth zone samples (n=50) and Bermingham (n = 29) are shown in Table 4-2 and Table 4-3, respectively. No SFE data are available for the other deposit areas that have appropriate trace element detection limits.

The discussion of the results is focussed on constituents that were found to be elevated relative to crustal abundance from bulk elemental analysis and/or had SFE test data that were elevated relative to Canadian Council of Ministers of the Environment (CCME, 2017) or British Columbia Ministry of the Environment (BCMOE, 2016) long-term water quality guidelines for freshwater aquatic life. Where both CCME and BCMOE guidelines were available for a constituent, the most recently updated guideline was used since this captures the most recent scientific publication related to environmental risk. Although such short-term leach extractions are not strictly comparable to water quality guidelines, such comparison aids in the identification of elevated concentrations of potentially soluble constituents and the potential for trace element leaching. This comparison is strictly for reference purposes and does not indicate compliance or otherwise with CCME, BCMOE or other water quality guidelines.

The pH of both sets of SFE sample datasets was circumneutral to alkaline, with a few samples (three Bermingham and two Flame & Moth) in exceedance of the upper CCME pH guideline (pH 9.0). Also, four Bermingham samples had SFE pH lower than the CCME pH lower guideline (pH 6.5). Elevated concentrations of SFE leachable fluoride (92% of samples exceeded 0.12 mg/L CCME guideline) and aluminum (76% of samples exceeded 0.1 mg/L CCME guideline) were observed in the Flame & Moth samples, whereas a lower proportion of exceedances (and lower concentrations) were obtained for the Bermingham samples (45% and 31% of samples exceeded guidelines for fluoride and aluminum, respectively).

A high proportion of SFE leachable antimony concentrations exceeded the BCMOE interim guideline (0.009 mg/L; 78% of samples) in the Flame & Moth dataset, whereas only six (21%) exceedances were observed for the Bermingham samples despite higher bulk antimony concentrations in the Bermingham waste rock samples (Figure 4-8 and Figure 4-9). Conversely, a higher proportion of Bermingham samples had SFE leachable arsenic concentrations that exceeded the CCME water quality guideline (0.005 mg/L; 41% of samples) compared with the Flame & Moth SFE results (6% of samples), consistent with the higher bulk arsenic in Bermingham samples (Figure 4-9). On the other hand, a similar proportion of Flame & Moth SFE leachable selenium concentrations exceeded the BCMOE guideline for selenium (0.002 mg/L; 46% of samples) as with the Bermingham dataset (45% of samples), although both sample datasets spanned a similar concentration range (Figure 4-9).

Broadly positive correlations were observed between SFE leachable and aqua regia bulk concentrations of aluminum and selenium (Figure 4-9), although the selenium correlation appears stronger within each deposit area's lithology rather than for the entire dataset.

Overall, the same constituents (fluoride, and selenium) were observed at elevated levels in the SFE leachate from both the Bermingham and Flame & Moth samples. The only notable differences were the elevated arsenic

concentrations observed in 41% of the Birmingham samples, but only 6% of the Flame & Moth samples, and the elevated antimony and aluminum concentrations which were recorded in the majority of Flame & Moth dataset, but which were generally lower than the water quality guidelines in the Birmingham samples.

Table 4-2: Comparison of SFE data from Flame & Moth Zone Samples with Water Quality Guidelines

n = 50	pH	Fluoride	Aluminum	Antimony	Arsenic	Selenium
		mg/L	mg/L	mg/L	mg/L	mg/L
Guideline for Comparison	CCME	CCME	CCME	BCMOE	CCME	BCMOE
Aquatic Life Guideline	6.5 - 9.0	0.12	0.1 ^a	0.009	0.005	0.002
Maximum	9.2	4.49	6.2	0.13	0.012	0.030
3rd Quartile	8.7	0.94	0.63	0.027	0.0018	0.0036
Median	8.6	0.51	0.29	0.013	0.0012	0.0018
1st Quartile	8.4	0.28	0.10	0.0094	<0.0005	0.00085
Minimum	7.9	0.068	0.017	0.00099	<0.0005	0.00025
Samples >CCME/BCMOE	4%	92%	76%	78%	6%	46%
Highlighted Results Exceed CCME/BCMOE						

^a Guideline based on receiving waters with pH>6.5

Table 4-3: Comparison of SFE data from Birmingham Zone Samples with Water Quality Guidelines

n = 29	pH	Fluoride	Aluminum	Antimony	Arsenic	Cadmium	Selenium
		mg/L	mg/L	mg/L	mg/L	mg/L	mg/L
Guideline for Comparison	CCME	CCME	CCME	BCMOE	CCME	CCME	BCMOE
Guideline Value	6.5 - 9.0	0.12	0.1 ^a	0.009	0.005	0.0002 ^b	0.002
Method Detection Limit	-	0.01	0.0005	0.00005	0.00002	0.000005	0.00004
Maximum	9.3	0.80	0.58	0.032	0.066	0.0004	0.03
3rd Quartile	8.8	0.26	0.11	0.005	0.011	0.00004	0.004
Median	8.1	0.10	0.04	0.002	0.003	0.00002	0.002
1st Quartile	7.1	0.07	0.02	0.001	0.002	0.00001	0.0004
Minimum	6.2	0.04	0.004	0.0004	0.0006	0.000003	0.00005
Samples >CCME/BCMOE	7	13	9	6	12	1	13
Percent >10x Crustal Abundance	24%	45%	31%	21%	41%	3%	45%
Highlighted Results Exceed CCME/BCMOE							

^a Guideline based on receiving waters with pH>6.5

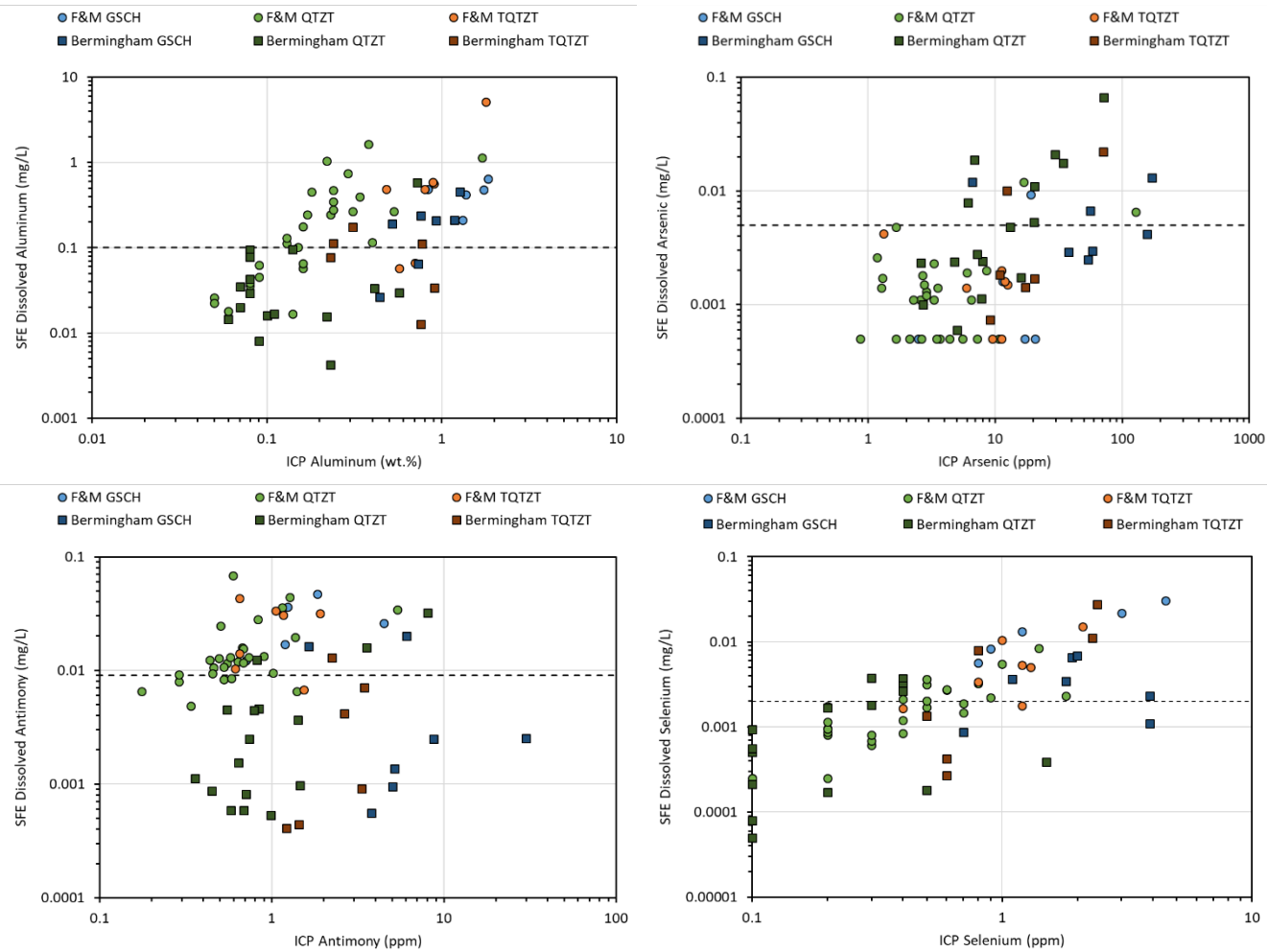

Figure 4-9: Comparison of SFE Leachable and Aqua Regia Bulk Concentrations of Aluminum, Antimony, Arsenic, and Selenium for the main lithologies in Bermingham (squares) and Flame & Moth (circles)

5 KINETIC TESTING DATA

Concentrations of constituents of interest in the leachate from the kinetic experiments conducted using waste rock are presented and discussed here. The effluent quality standards (EQS) set out in water licence QZ09-092, water quality objectives (WQO) at KV-21 for Bermingham, and Canadian Council of Ministers of the Environment (CCME) or British Columbia Ministry of Environment (BCMOE) (whichever is the most recent) water quality guidelines for the protection of aquatic life are also displayed where applicable for comparative purposes. The lower (i.e., 25th) percentile hardness and dissolved organic carbon (DOC) and the upper (i.e., 75th) pH for the nearest receiving environment was used to calculate hardness-dependent guidelines based on the 2013 to 2017 dataset:

- Station KV-51 in Christal Creek was used for Flame & Moth waste rock (25th percentile hardness 527 mg/L; 25th percentile DOC 8.6 mg/L and 75th percentile pH 7.3); and
- Station KV-21 in No Cash Creek was used for Bermingham waste rock (25th percentile hardness 327 mg/L).

5.1 HUMIDITY CELLS

5.1.1 Flame & Moth

One humidity cell was conducted using a composite of N-AML Flame & Moth waste rock and operated for 98 weeks. Details regarding the composition (ABA, metal content, etc.) of this humidity cell can be found in AEG (2016b).

pH, Acidity, Alkalinity and Sulphate

The Flame & Moth N-AML humidity cell leachate remained slightly alkaline, ranging from pH 7.5 to 8.4 (Figure 5-1) throughout the test period. The alkalinity was higher than the acidity generated during the entire test period. But declined from a peak of 127 mg/L CaCO₃ at week 1 to stabilize between 49 and 61 mg/L CaCO₃ since week 60 (Figure 5-1). Acidity was not measured during the first 9 weeks of humidity cell operations. At week 10, acidity was 16.9 mg/L CaCO₃, but since then remained below 6 mg/L CaCO₃, typically ranging between 1 and 2 mg/L CaCO₃ (Figure 5-1). Dissolved sulphate concentrations were the highest during the initial rinse cycle (183 mg/L at week 0) as soluble metal sulphate salts, which likely accumulated during sample storage, were washed out of the cell. Sulphate concentrations then declined slightly before reaching a plateau of between 98.9 and 129 mg/L for weeks 2 to 11 (Figure 5-1), which was likely due to a supply of metal sulphides undergoing weathering within the humidity cell. Sulphate levels declined thereafter, stabilizing between 20 and 28 mg/L since week 66 (Figure 5-1). Sulphate concentrations was below the BCMOE guideline (429 mg/L) at all times.

Trace Elements of Interest

Concentrations of cadmium, zinc, silver, lead, nickel, and copper in the Flame & Moth N-AML humidity cell leachate were typically below their respective detection limits for the majority of the 98 week operation, and well below their respective water quality guidelines (Figure 5-1 and Figure 5-2).

Antimony concentrations were highest during the initial rinse (0.011 mg/L), marginally exceeding the BCMOE working water quality guideline (0.009 mg/L), before they gradually declined over time. Antimony concentration stabilized and remained ≤ 0.001 mg/L since week 41 (Figure 5-3). Arsenic concentrations exhibited a stable concentration between 0.00071 and 0.00091 mg/L between week 0 and week 15 (Figure 5-3). After week 15, arsenic levels began to slowly increase, reaching 0.0024 mg/L by week 54, before declining slightly and stabilizing between 0.0016 and 0.002 mg/L since week 70 (Figure 5-3). Throughout the test period, the humidity cell leachate arsenic concentration was still at least two times lower than the CCME guideline (0.005 mg/L).

Selenium concentrations in the humidity cell leachate showed a different pattern than all other constituents. It initially declined from the initial flush value of 0.0028 mg/L to approximately 0.001 mg/L over the first two weeks before rising sharply to a peak concentration of 0.0031 mg/L at week 8 (Figure 5-3). The selenium peak coincided with the sustained elevated sulphate levels, suggesting that the dissolution of selenium-bearing metal sulphides is the likely source of selenium, and hence result in these higher selenium concentrations. Dissolved selenium concentrations then tailed off sharply as it rose, stabilizing between 0.0003 and 0.0005 mg/L from week 31 onwards (falling below the BCMOE guideline of 0.002 mg/L after week 12).

It is estimated that that the time to sulphides and NP depletion are in order of 16 and 54 years, respectively, indicating that significant portion of NP will remain after the sulphide minerals have been exhausted. The humidity cell was terminated after the concentrations of constituents of interest have stabilized. Preliminary closedown static test results show that the acidity potentially generated from remaining sulphides is less than 0.5 kg CaCO₃/t significantly lower than remaining NP (51 kg CaCO₃/t).

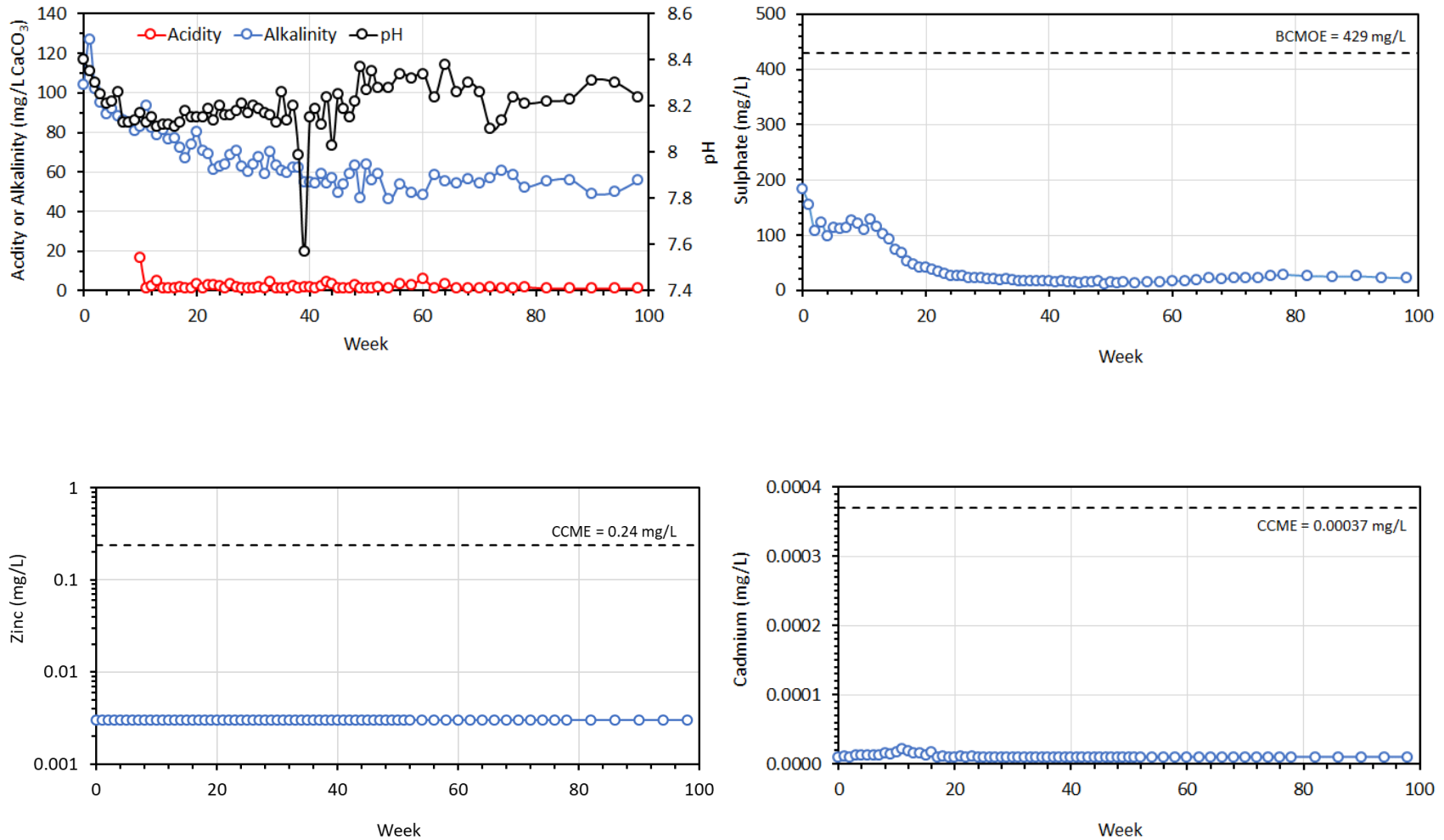

Figure 5-1: Acidity, Alkalinity, pH, Sulphate, Zinc and Cadmium Trends within the Flame & Moth N-AML Waste Rock Humidity Cell

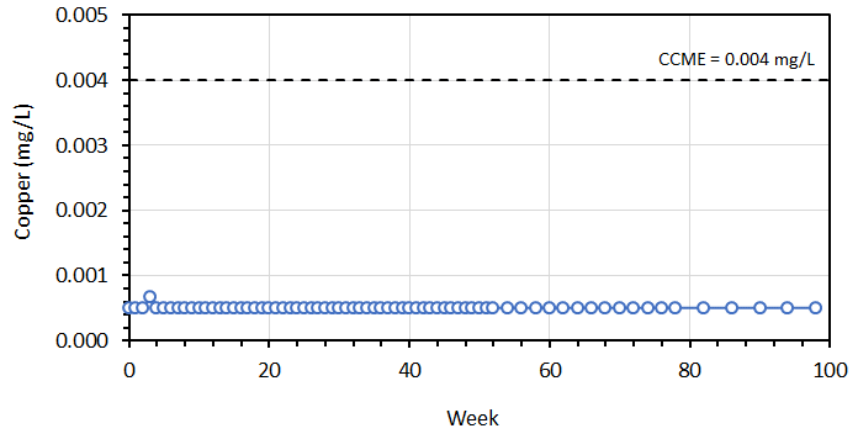
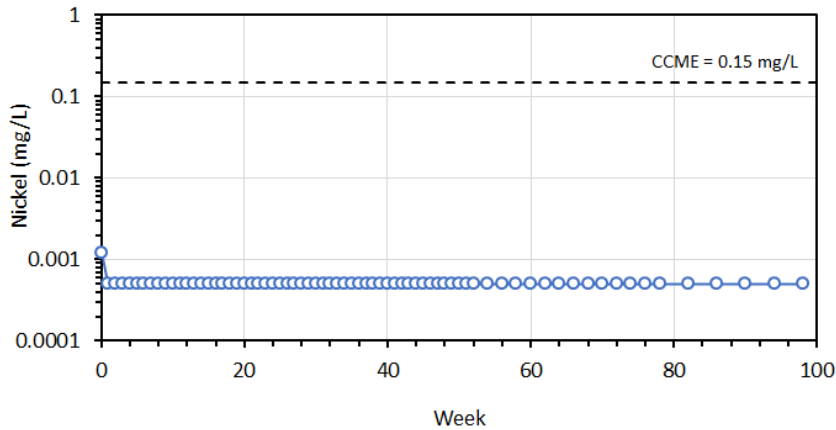
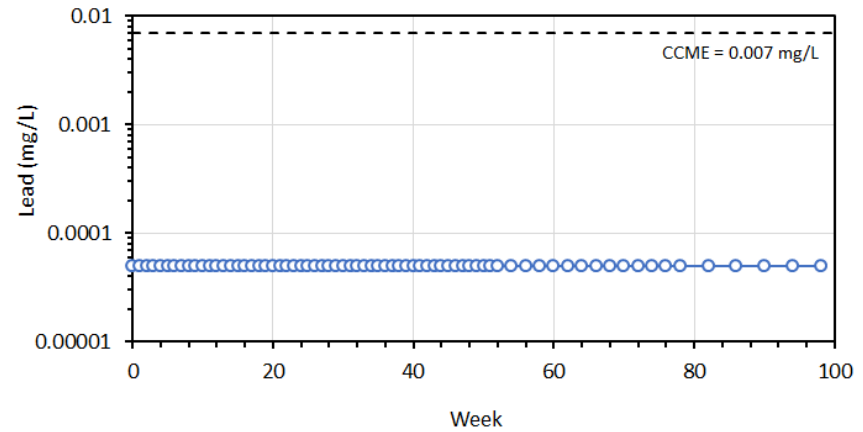
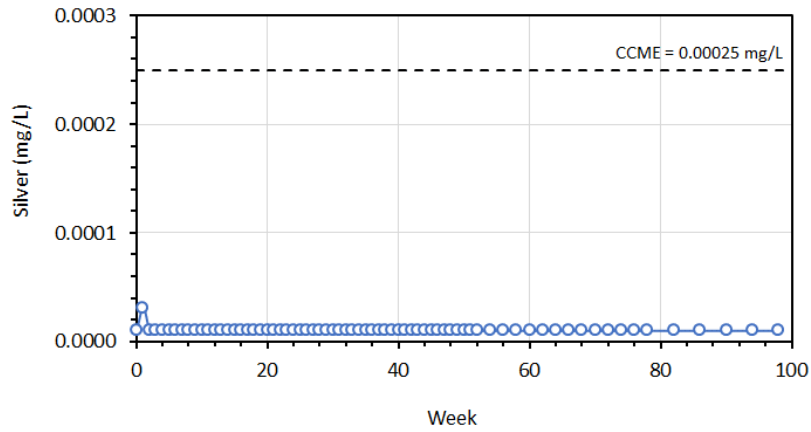

Figure 5-2: Silver, Lead, Nickel, and Copper Trends within the Flame & Moth N-AML Waste Rock Humidity Cell

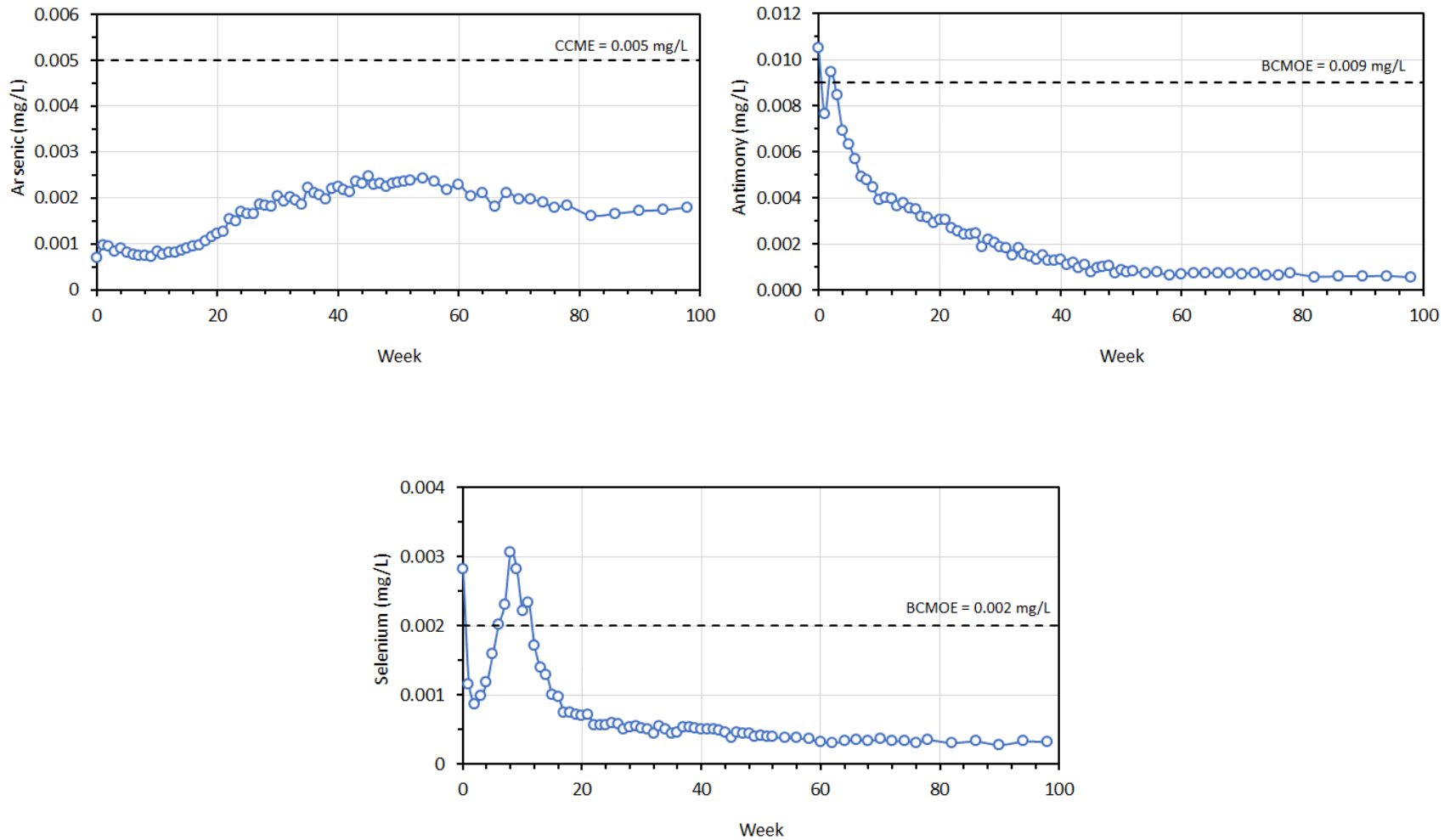

Figure 5-3: Arsenic, Antimony and Selenium Trends within the Flame & Moth N-AML Waste Rock Humidity Cell

5.1.2 Birmingham

Two waste rock humidity cells were operated to understand the potential for acid rock drainage and metal release rates from the Birmingham N-AML waste rock. The first humidity cell (HC-01) was constructed using a composite of N-AML Birmingham waste rock from cover holes with total sulphur and NP closer to the lower percentile (36%), NP close to the median (51%) of ABA data and an NPR of 4.1 (Total sulphur = 0.09 Wt.%; NP= 10.3 kg CaCO₃/t; AP= 2.5 kg CaCO₃/t). The cell also had elevated trace metal contents close to the 70th percentile and was operated for 57 weeks (Table 5-1). The second humidity cell (HC-03) was constructed using a composite of N-AML Birmingham waste rock from advanced exploration drill holes with total sulphur close to the 78th percentile, NP close to the 87% percentile, AP close to the 79% of ABA data and an NPR of 2.6 (Total sulphur = 0.36 Wt.%; NP= 29.0 kg CaCO₃/t; AP= 11.3 kg CaCO₃/t). The second cell also had elevated trace metal content close to the 90th percentile of the elemental data and was operated for 107 weeks (Table 5-2). Figure 5-4 to Figure 5-6 present the humidity cell leachate data collected for constituents of interest.

Table 5-1: Select ABA and Trace Element Composition of N-AML Humidity Cell Material HC-01

	Paste pH	Total Inorganic Carbon	Carbonate NP	Total Sulphur	Sulphate Sulphur	Sulphide Sulphur	AP	NP	Neutralization Potential Ratio
	pH Units	wt%	kg CaCO ₃ /t	wt%	wt%	wt%	kg CaCO ₃ /t	kg CaCO ₃ /t	N/A
	8.00	0.21	4.8	0.09	0.01	0.08	2.5	10.3	4.1
Percentile:	37%	63%	53%	36%	48%	36%	36%	51%	68%
	Arsenic	Antimony	Cadmium	Copper	Lead	Nickel	Selenium	Silver	Zinc
	ppm	ppm	ppm	ppm	Ppm	ppm	ppm	ppm	ppm
	41	2.4	0.39	12	12	15	1.1	0.38	76
Percentile:	81%	66%	65%	69%	66%	54%	80%	69%	69%

Table 5-2: Select ABA and Trace Element Parameter Composition of High Sulphide N-AML Humidity Cell Material HC-03

	Paste pH	Total Inorganic Carbon	Carbonate NP	Total Sulphur	Sulphate Sulphur	Sulphide Sulphur	AP	NP	Neutralization Potential Ratio
	pH Units	wt%	kg CaCO ₃ /t	wt%	wt%	wt%	kg CaCO ₃ /t	kg CaCO ₃ /t	N/A
	8.58	1.25	28.4	0.36	0.01	0.36	11.3	29.0	2.6
Percentile:	82%	95%	92%	78%	48%	79%	79%	87%	60%
	Arsenic	Antimony	Cadmium	Copper	Lead	Nickel	Selenium	Silver	Zinc
	ppm	ppm	ppm	ppm	ppm	ppm	ppm	ppm	ppm
	17	2.2	1.03	16	32	13	0.6	0.61	115

	Paste pH	Total Inorganic Carbon	Carbonate NP	Total Sulphur	Sulphate Sulphur	Sulphide Sulphur	AP	NP	Neutralization Potential Ratio
Percentile:	59%	62%	89%	77%	90%	47%	61%	79%	84%

pH, Acidity, Alkalinity and Sulphate

The Bermingham humidity cell HC-01 leachate was circumneutral (pH 6.7 to 7.6; Figure 5-4), with relatively low levels of alkalinity (4.5 to 16 mg/L CaCO₃) and negligible acidity (below or at the detection limit of 0.5 mg/L CaCO₃). Sulphate concentrations were also low, ranging between 2.5 and 15.3 mg/L, over an order of magnitude lower than the sulphate WQO (524 mg/L; Figure 5-4).

The leachate from the higher sulphur cell HC-03 was also neutral to slightly alkaline (pH 7.3 to 8.1; Figure 5-4) with relatively low levels of alkalinity (9.0 to 42.1 mg/L CaCO₃) and acidity mostly below the detection limit except in a few cases (<0.5 to 1.1 mg/L CaCO₃). These parameters reflect the higher sulphide-sulphur and NP content of this cell compared to HC-01. Sulphate concentrations from HC-03 were also higher than HC-01, ranging between 10.9 and 42.8 mg/L, reflecting its elevated sulphur content. The sulphate concentration difference between the two cells has gradually widened after cycle 16. Sulphate concentration of the HC-03 was also several times lower than WQO (524 mg/L; Figure 5-4).

The sulphate release trends of the Bermingham cells were comparable to that of Flame & Moth but the concentrations released were different. Sulphate content of HC-01 was an order of magnitude lower due to its lower sulphide content compared to the Flame & Moth humidity cell composite sample. Bermingham HC-03 also had lower sulphate than Flame & Moth during the first 20 cycles, then the sulphate release rate increased resulting in higher sulphate in HC-03 over Flame & Moth after the 25th week until week 65 after which the concentration decreased below the Flame & Moth. Sulphate leached from HC-03 has decreased gradually since week 35 (37 mg/L) reaching sulphate level of 14.5 mg/L at the last week of testing.

Trace Elements of Interest

Aside from selenium in HC-01, antimony and copper in HC-03 the concentrations of all constituents of interest in the leachates of Bermingham N-AML humidity cells were consistently well below their respective WQO, EQS, CCME or BCMOE values (Figure 5-4 to Figure 5-6). Selenium in HC-01 concentrations peaked at 0.009 mg/L after week one, then continued to decline gradually such that by week 11 (0.0018 mg/L) they were below the BCMOE (0.002 mg/L). Selenium concentration in HC-03 had a similar pattern as HC-01, but with concentrations constantly below HC-01 and the WQO. Selenium concentrations in HC-03 gradually decreased since the peak measured at week 03. It is worth noting that among all constituents of interest analyzed only selenium concentrations were regularly higher in the Bermingham HC-01 leachate compared to Flame & Moth, except during weeks 8-9. Selenium concentrations in HC-03 were comparable to the Flame and Moth except between cycles 6 and 16 when the concentration in the Flame & Moth peaked. Copper concentration in HC-01 and HC-03 were consistently more than one order of magnitude below the WQO except for two isolated peaks at weeks 83 and 87 (0.0147 – 0.0175 mg/L) where the concentration exceeded the WQO. Copper concentration was consistently below the detection limit (0.0005 mg/L) in the Flame & Moth. Cadmium concentration in HC-01 and HC-03 were two to three orders of magnitude lower than the Bermingham EQS. Cadmium concentrations were higher in the Bermingham leachates than Flame & Moth during the first ~40 weeks before

declining and becoming comparable with Flame & Moth concentrations then lower during the last weeks of testing for HC-01 and HC-03. Arsenic concentrations in HC-01 and HC-03 were also more than an order of magnitude lower than the WQO. The arsenic concentrations were also higher in the Bermingham leachates than Flame & Moth during the first ~20 weeks, before gradually declining below the Flame & Moth concentrations thereafter (Figure 5-6)

The concentrations of arsenic, cadmium, zinc, lead, nickel, and copper in the Bermingham N-AML humidity cell HC-01 and HC-03 were relatively low and more than an order of magnitude below their water quality guidelines (Figure 5-4 through Figure 5-6). The concentrations of these elements in the Bermingham humidity cell leachates were initially lower or became lower during the last cycles than those observed in the Flame & Moth humidity cell; however, this is largely due to the better detection limits available for the Bermingham test work and the high detection limit used in Flame & Moth. Silver was below the detection limit in all humidity cells.

Aside from selenium, HC-03 had higher (pH, sulphate, zinc, cadmium, nickel, antimony, and molybdenum) or comparable (copper) leachate concentrations compared to HC-01 reflecting its higher sulphur and bulk metal contents. HC-03 had lower lead, arsenic and selenium at during the last 20 weeks of operation of HC-01.

The time to sulphide and NP depletion in the Bermingham N-AML waste rock humidity cell HC-01 was calculated to be 21 and 39 years, respectively, while HC-03 provided shorter sulphide depletion times (18 years) and NP depletion time (21 years). This indicates that a significant portion of NP will remain in HC-01 after the sulphide minerals have been depleted but only a limited amount of NP will remain after HC-03 is depleted from its sulphide sulphur. Both humidity cells were terminated after the concentrations of constituents of interest had stabilized. Closedown static test data for HC-01 and HC-03 indicated that the acidity potentially from the remaining sulphides was less than 2 and 8.8 kg CaCO₃/t, respectively, significantly lower than the remaining NP (7.3 and 49 kg CaCO₃/t, respectively), consistent with the sulphide and NP depletion calculations. The results are also consistent with the mineralogical data showing low sulphides (0.6 - 0.7wt.%) and the presence of reactive carbonates (0.4 - 2.0 wt.%) in the cell residues

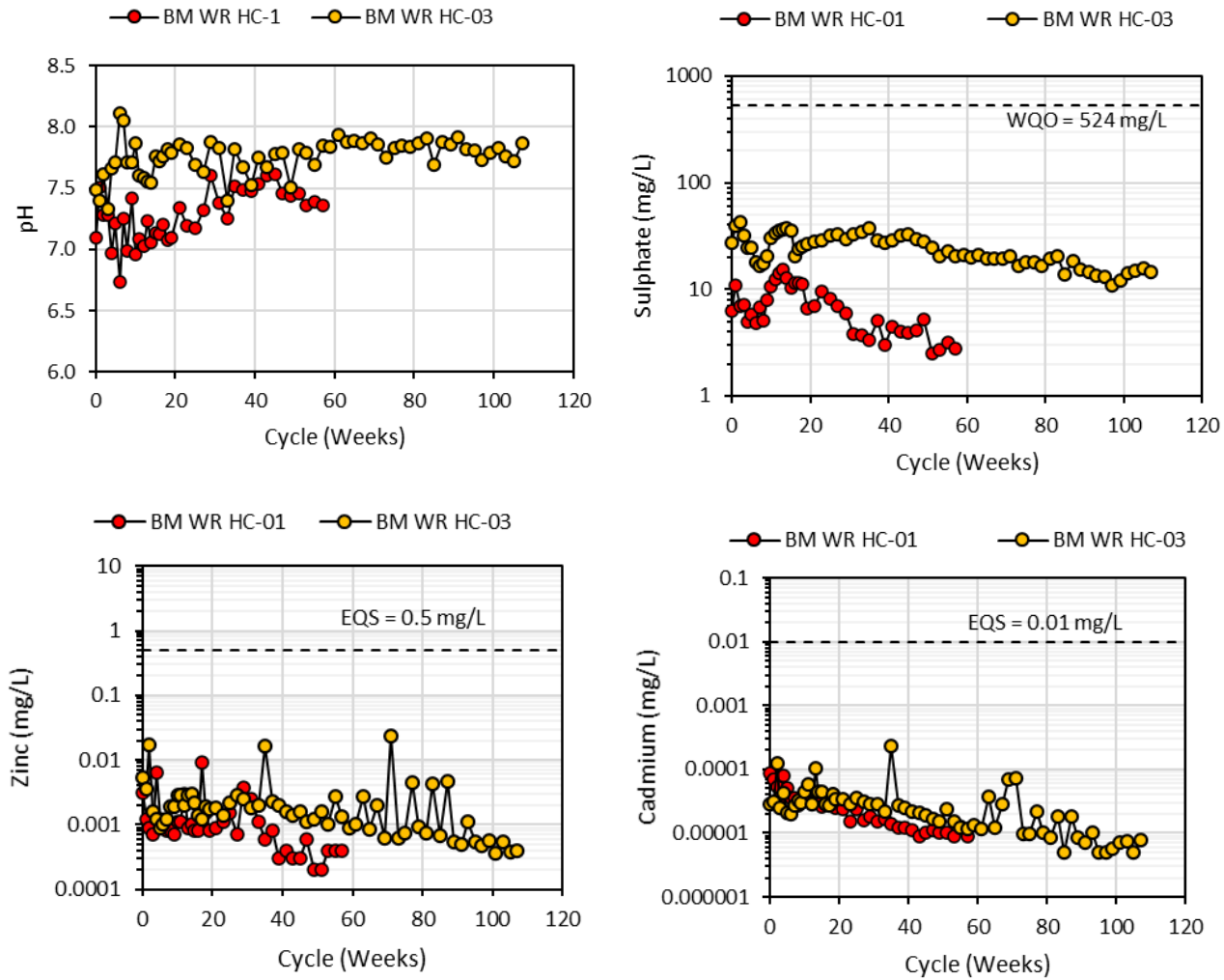

Figure 5-4: pH, Sulphate, Zinc and Cadmium Trends within the Bermingham N-AML Waste Rock Humidity Cells

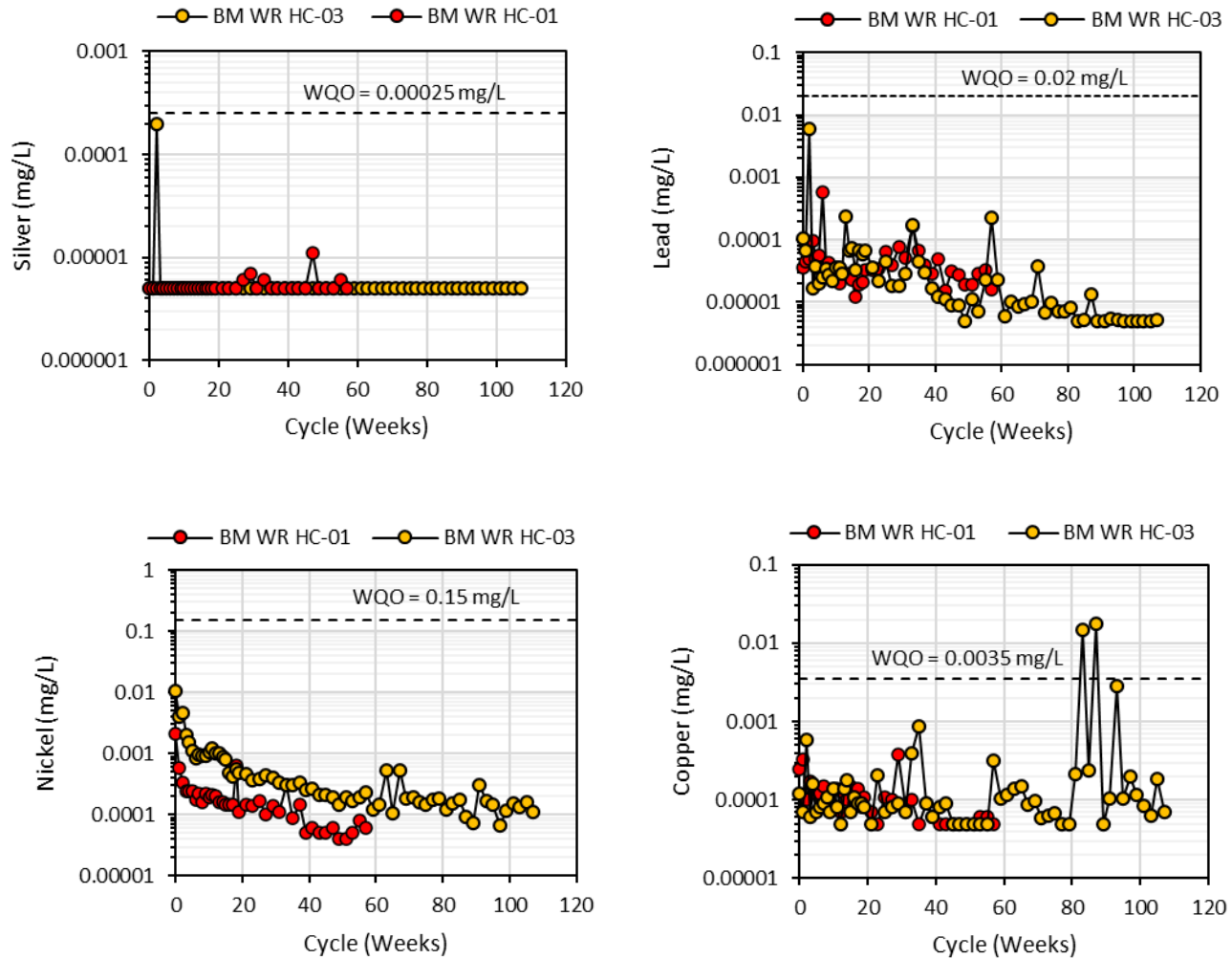

Figure 5-5: Silver, Lead, Nickel, and Copper Trends within the Birmingham N-AML Waste Rock Humidity Cells

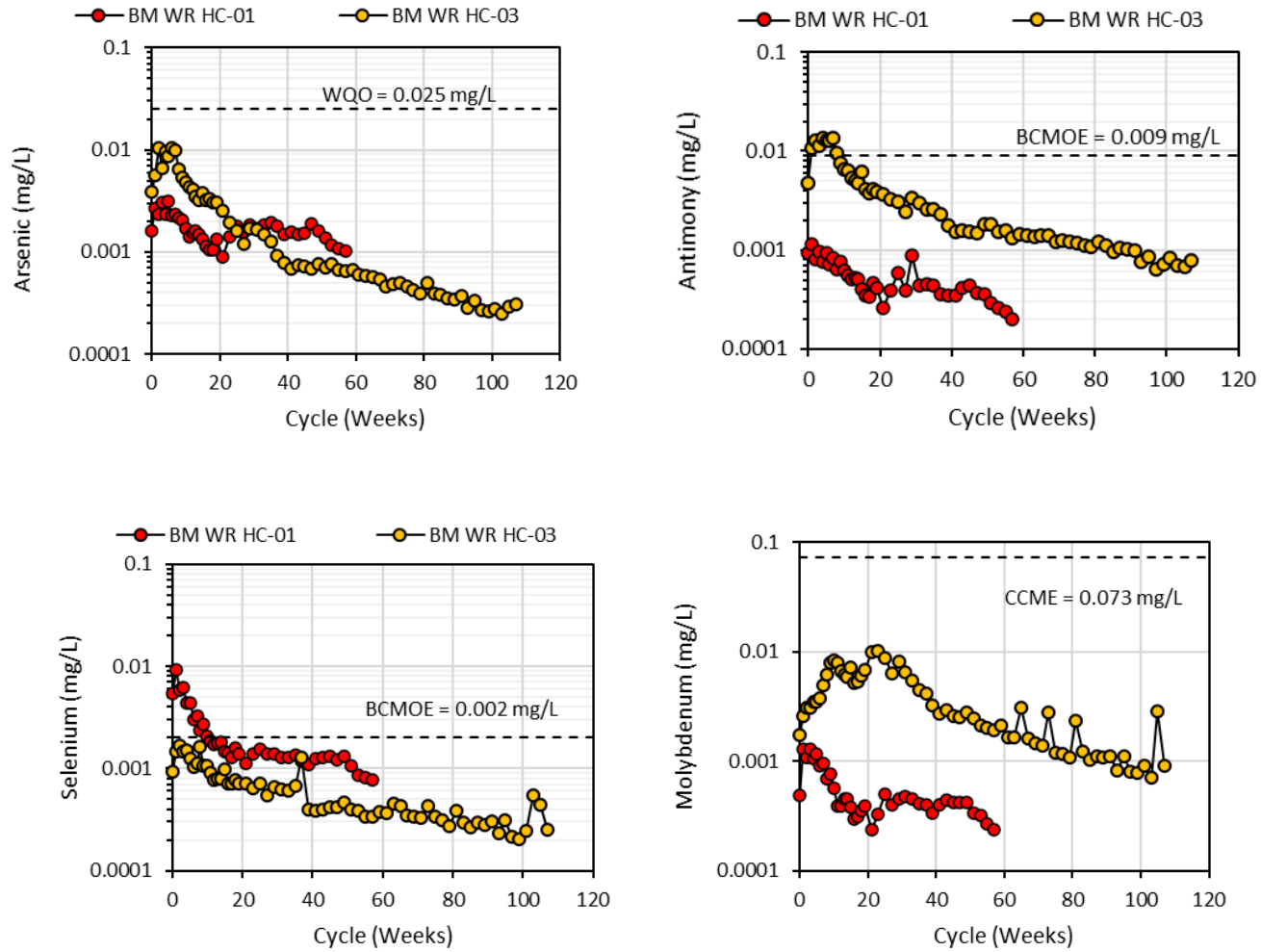

Figure 5-6: Arsenic, Antimony Selenium and Molybdenum Trends within the Bermingham N-AML Waste Rock Humidity Cells

5.2 FIELD BARRELS

Five field barrels containing Flame & Moth waste rock were constructed onsite in the June 2013 and continue to be monitored to date. Only field leach barrels 1 to 4 are used to evaluate the proposed Flame & Moth geochemical waste rock management screening criteria and their results are discussed and displayed here. The bulk composition of field bin 5 is not representative of the material to be generated by the screening criteria proposed for Flame & Moth; therefore, the results are not discussed in this memorandum.

Field barrels 1 through 4 were built to examine P-AML and N-AML from the dominant lithologies to be encountered in the development of the Flame & Moth deposit, specifically in the area of the decline. Field barrel 1 (FMB1) was filled with P-AML rock as indicated by its elevated sulphur content (median 2.79% sulphur), median NPR <1, and high maximum metal concentrations. Field barrel 2 (FMB2) was filled entirely with N-AML rock using the Bellekeno geochemical screening criteria, and has the highest median NP, relatively low sulphur content and lowest median and maximum metal content of all the field bins. Field barrels 3 and 4 (FMB3 and FMB4) were filled with N-AML rock using the proposed Flame & Moth screening criteria, but which according to the Bellekeno screening criteria contained portions of P-AML designated waste rock. This is primarily reflected in the sulphur content (median 0.39% and 0.43% for FMB3 and FMB4, respectively) and NPR (median 1.9 and 3.1 for FMB3 and FMB4, respectively) for these field barrels. These field leach barrels were constructed to examine the impact of P-AML rock on the overall acid rock drainage/metal leaching (ARD/ML) behaviour from the dominantly N-AML waste rock materials that would be extracted and stored within surface waste rock dumps during the development of the Flame & Moth decline/deposit. Further details regarding the composition of the field barrels can be found in AEG (2016b). All the barrels are generally sampled at least four times a year except in 2019 when they were only sampled twice due to dry conditions and lack of leachate in the collection bins.

pH, Acidity, Alkalinity and Sulphate

The field barrel leachate pH fluctuated but has remained circumneutral to slightly alkaline during most of the monitoring period until 2016. Since 2016, leachate pH below 6.5 was constantly observed in FMB1 and occasionally observed (three times) in FMB2. FMB1 generally displayed the lowest pH values (below pH 6.0 since September 2017) consistent with its P-AML designation, whereas the highest pH values were often recorded in the leachate from FMB3 although its pH decreased below 6.5 during the September 2018 and 2019 samplings events. All N-AML barrels had leachate pH <6.5 during the September 2018 and 2019 sampling events except FMB4 that had a pH of 7.6 in 2019.

This trend was reversed for the acidity levels, where FMB1 consistently exhibited significantly higher acidity (<1.0 – 226 mg/L CaCO₃) than observed for FMB2, FMB3 and FMB4 (<1.0 – 4.8 mg/L CaCO₃; Figure 5-7). The acidity difference between FMB1 and the N-AML barrels increased significantly as the test progressed reaching about 200 mg/L CaCO₃ during the 2018 last two sampling events then the gap decreased to 40 mg/L in May 2019. The September 2019 acidity result for FMB1 was unusually high as the concentration reached 1560 mg/L CaCO₃. Since the cell had remained undrained since May 2019, it is believed that soluble products had accumulated in the barrel between May and July and were flushed out in September 2019. Alkalinity levels showed some limited correlation with pH, as FMB1, which was had the lowest leachate pH range also had the

lowest alkalinity (<0.5 – 56 mg/L CaCO₃). This is consistent with the P-AML bulk rock materials composition that comprised FMB1. In general, alkalinity levels were the highest at the start of the field barrel experiment and declined gradually as the test progressed. FMB1 alkalinity was below the detection limit during the last six sampling events indicating a depletion of buffering capacity and explaining the acidic leachate pH observed.

FMB1 and FMB3 showed the highest and lowest dissolved sulphate concentrations, respectively (Figure 5-7). Dissolved sulphate concentrations were typically highest in the warmer summer months (July-September) and lowest for the spring and fall sampling events, except for the 2017 and 2018 datasets, which showed a general increase in sulphate concentrations through the year (Figure 5-7). Indeed, leachate from the P-AML FMB1 recorded its highest sulphate concentration to date (4,930 mg/L) in the September 2019 sampling event. FMB1 sulphate concentrations always exceeded the BCMOE guideline (429 mg/L), leachate from FMB3 generally had sulphate concentrations below the BCMOE guideline, whereas the sulphate concentration in FMB2 and FMB4 oscillated about the BCMOE guideline. All field barrel samples exceeded the BCMOE sulphate guidelines in September 2019 likely due to the build up of soluble products in the field barrels between May and July and subsequent flushing in September.

Trace Elements of Interest

The trace element leaching trends were broadly consistent with the P-AML / N-AML classification of the rock that comprised each field barrel. FMB1 was composed of P-AML material and the leachate from this bin regularly contained the highest concentrations of zinc, cadmium, nickel, lead, copper, and silver (Figure 5-8 and Figure 5-9) with cadmium and zinc constantly exceeding the EQS and nickel and copper in exceedance since August 2016. FMB2, FMB3, and FMB4 were primarily composed of N-AML rock. These field barrels generally exhibited much lower zinc, cadmium, nickel, lead, copper, and silver leachate concentrations, and did not exceed any QZ09-092 EQS except six copper exceedances in FMB4 between 2016 and 2019, one copper exceedance in FMB2 in 2017, and one cadmium and zinc exceedance in FMB3 in 2019 (Figure 5-8 and Figure 5-9).

Zinc

Leachate from the N-AML rock-bearing materials found within FMB4 had the lowest zinc concentrations, which were consistently below the CCME guideline (0.24 mg/L; Figure 5-8). Leachate zinc concentrations from FMB2 were also typically lower than the CCME guideline although higher than FMB4. Leachate zinc concentrations from FMB3 were higher than FMB2 and FMB4, recurrently higher than the CCME guideline but constantly lower than the EQS for zinc (0.5 mg/L) except during the last sampling event when unusually high sulphate and low pH were observed. FMB1 consistently showed the highest zinc concentrations (0.4 – 105 mg/L) between 2013 and 2018 and an unusually high zinc release in September 2019 (722 mg/L). Almost all the FMB1 samples exceeded the EQS for zinc and were one to two orders of magnitude higher than the zinc levels recorded in the other field barrels. Zinc concentrations observed in 2017 and 2018 in FMB1 had comparable patterns and the leachate zinc levels were generally higher than in previous years, consistent with the higher sulphate (2017) and acidity levels (2017 and 2018). This metal leaching behaviour is in line with the predominantly P-AML rock that comprises FMB1. The zinc concentration in leachates collected from the N-AML field leach barrels FMB1, FMB2, and FMB3 have not exceeded the EQS to date except for the last sampling event for FMB3 (September

2019). The high zinc release in 2019 coincided with the highest sulphate release indicating a common source, likely the flushing of soluble weathering products stored in the field barrels since May 2019 sampling event.

Cadmium

Cadmium concentrations followed remarkably similar trends to those of zinc (Figure 5-8). The cadmium concentration in the leachate for all the field barrels FMB1 and FMB3 exceeded the CCME guideline (0.00037 mg/L) for all samples collected to date. FMB2 leachate cadmium concentrations also regularly exceeded the CCME guideline with one decrease below the CCME guideline in 2015. FMB4 cadmium concentrations were regularly lower or slightly higher than CCME (Figure 5-8) except in September 2019 when the concentration was almost one order of magnitude higher than CCME guideline. FMB1 displayed the highest leachate cadmium levels (0.01 – 1.5 mg/L), all of which exceeded the EQS (0.1 mg/L), further confirming the P-AML nature of the rock used for this field barrel. Like zinc, cadmium concentrations observed in 2017 and 2018 in FMB1 leachate had similar patterns and were generally higher than in previous years, consistent with the higher sulphate (2017 and 2019) and acidity levels (2017 – 2019) observed. Leachate from the other three N-AML rock filled field barrels contained cadmium levels that were below the EQS except the last sampling event of FMB3 where the concentration exceeded the EQS (0.0315 mg/L) Like zinc and sulphate, unusually high cadmium concentrations were recorded in all field barrels in September 2019.

Nickel

Nickel concentrations were highest in the leachate from the P-AML rock-bearing materials in FMB1 (Figure 5-8). The nickel level exceeded the CCME threshold (0.15 mg/L) for all FMB1 samples collected since June 2015, with the EQS nickel threshold (0.5 mg/L) exceeded in three consecutive sampling events in the summer and fall of 2015, and the majority of sampling events since July 2016. Like zinc and cadmium, nickel concentrations observed in 2017 and 2018 in FMB1 leachate were generally higher than in previous years, consistent with higher sulphate (2017 and 2019) and acidity levels (2017 – 2019). The nickel concentrations in the leachate collected from the three N-AML field barrels (FMB2, FMB3 and FMB4) have gradually declined over the monitoring period until September 2019 when relatively high nickel concentrations were recorded. Nickel concentrations in leachate from FMB2, FMB3 and FMB4 never exceed the CCME guideline or the EQS (Figure 5-8). Like zinc, sulphate, and cadmium, unusually high nickel concentrations were measured in all field barrels in September 2019 likely due to accumulation of soluble nickel-bearing weathering products over the summer.

Lead

The leachate from FMB1 generally contained the highest lead concentrations (0.0013 – 0.74 mg/L), which constantly exceeded the CCME threshold (0.007 mg/L; Figure 5-8) since August 2016, and hence confirmed the P-AML nature of the rock materials used in this field barrel. Like other metal(oids), lead concentrations observed in 2017, 2018, and 2019 in FMB1 leachate were generally higher than in previous years, consistent with the higher sulphate (2017 and 2019) and acidity levels (2017, 2018 and 2019). Lead concentrations in FMB1 exceeded the EQS (0.2 mg/L) in July 2018 and September 2019. Lead concentrations in the leachate from the three N-AML field barrels (FMB2, FMB3 and FMB4; 0.00017 – 0.027 mg/L) were typically below the CCME guideline (0.007 mg/L) except in a few instances for FMB2 (June and July sampling events of 2015 – 2017 and September 2019) and one instance for FMB4 (September 2019). Like previous elements of interest and sulphate, the highest lead concentrations observed to date were recorded in September 2019, likely related to

flushing of soluble lead-bearing minerals that accumulated during weathering of the P-AML material over the summer. The lead concentrations from the N-AML field barrels in September 2019 was largely consistent with historical levels.

Copper

Copper concentrations followed a similar trend to those observed for lead except there was a higher rate of exceedances of the CCME copper guideline and EQS in leachates from N-AML barrels. The P-AML rock-bearing field leach barrel FMB1 (0.003 – 7.7 mg/L) generally exhibited the highest copper concentrations over the monitoring period, exceeding the EQS (0.1 mg/L) in the first three monitoring events in 2013 and for the majority or all of the 2017 – 2019 sampling events (Figure 5-9). Copper concentrations in leachate from N-AML FMB3 remained below both the EQS and CCME guideline (0.004 mg/L) for the majority of sampling events since late 2014 except in August 2018 and September 2019 when the leachate concentration surpassed the CCME guideline. Conversely, FMB2 exceeded the copper EQS once in 2017 and FMB4 periodically exceeded the EQS since 2016. Leachate copper concentrations from both FMB2 and FMB4 frequently exceeded the CCME threshold since the beginning of each test (Figure 5-9). Like other metals, an unusually high copper concentration was measured in FMB1 in September 2019 due to flushing of accumulated secondary weather products. The copper concentrations observed in the leachate from the N-AML field barrels in September 2019 were broadly consistent with historical levels.

Silver

The P-AML FMB1 displayed the highest silver concentration in its leachate (<0.00005 – 0.001 mg/L). It was not particularly elevated compared to the other N-AML field barrels (<0.00001 - 0.0001 mg/L; Figure 5-9) until September 2017 after which the silver concentration in the leachate from N-AML field barrels was typically below the detection limit whereas the P-AML silver concentration remained an order of magnitude higher. Only the initial sampling event and the September 2019 sample (0.00046 and 0.001 mg/L, respectively) exceeded the silver CCME guideline (0.00025 mg/L). The silver levels in leachate from other FMB1 sampling events and all the N-AML field barrels were below the CCME threshold and more than two orders of magnitude lower than the EQS (0.02 mg/L).

Arsenic

The leachate from FMB1 and FMB3 contained comparable levels of arsenic (typically 0.0005 – 0.012 mg/L), which were below the CCME threshold (0.005 mg/L) for all but three FMB1 samples collected to date (Figure 5-9). Arsenic concentrations in leachate from FMB2 and FMB4 were also comparable (0.006 – 0.019 mg/L), higher than FMB1 and FMB3, and exceeded or were comparable to the CCME limit for the majority of samples collected to date (Figure 5-9). The arsenic concentrations in all the field barrel leachates were well below the EQS (0.1 mg/L). Unlike all elements of interests discussed thus far, no increase of arsenic concentration was observed in any of the N-AML field barrels in September 2019.

Antimony

The antimony leaching behaviour was similar to that of arsenic. The lowest antimony concentrations were observed in leachate from FMB1 and FMB3 (0.0013 – 0.026 mg/L), in which the majority of the samples

collected to date were at, or below the BCMOE working guideline (0.009 mg/L) (Figure 5-9). The antimony levels in the leachate from FMB4 and FMB2 were all above or comparable to the BCMOE guideline, with the latter field barrel showing the highest antimony concentrations (0.012 – 0.071 mg/L). A declining trend in the leachate antimony concentration from the field barrels was broadly observed for all barrels. Like arsenic no increase of antimony concentration was observed in any of the N-AML field barrels in September 2019.

Selenium

The leachate selenium concentrations exceeded the BCMOE guideline (0.002 mg/L) for all samples collected to date from the FMB2 and FMB4 field barrels, and for the majority of samples collected from FMB1 and FMB3 (Figure 5-10). The lowest (FMB3: 0.00037 – 0.0087 mg/L) and highest (FMB2: 0.002 – 0.065 mg/L; FMB4: 0.0037 – 0.034 mg/L) selenium concentrations were observed in the leachate from the N-AML field barrels, suggesting that the leaching behaviour of this element cannot be predicted based on AML classification. It is however worth noting that an identical selenium pattern was observed for all field barrels since June 2016 despite the difference in selenium absolute concentrations. Also, an increase in leachate selenium concentration was observed in all field barrels in September 2019.

The similar patterns of zinc, cadmium, nickel, copper, and lead and their high concentration in the P-AML leach barrel FMB1, coincident with high sulphate and acidity levels, indicate a common source via sulphide oxidation. Conversely, the low concentrations of arsenic, antimony, and selenium in FMB1 leachate compared with the N-AML field barrels may suggest lower release rate of oxyanions under acidic conditions of the P-AML rock drainage compared with circumneutral N-AML drainage. A decrease of pH below 6.5 was observed in FMB3 in September 2018 and 2019. This tendency toward acidic pH may explain the low concentrations of arsenic, antimony and selenium in this barrel similar to that observed for the P-AML FMB1.

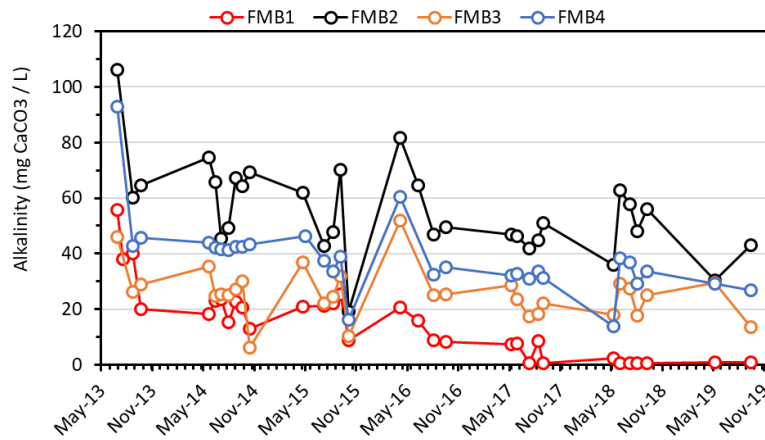
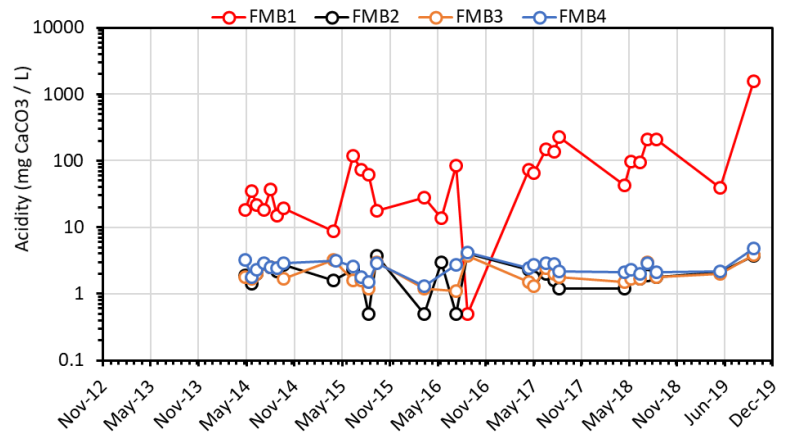
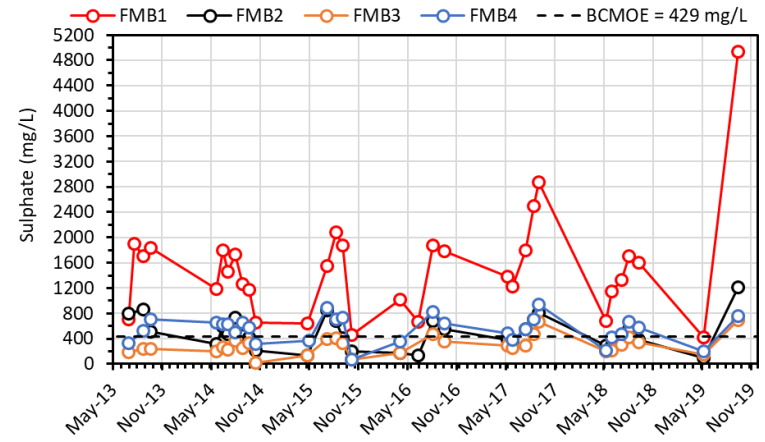
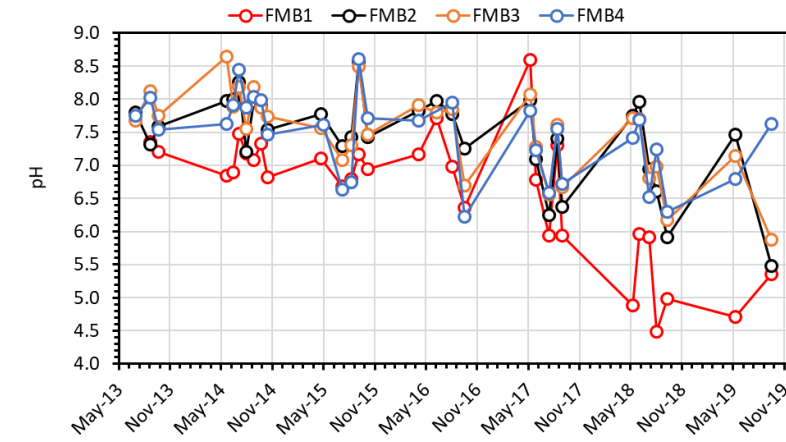

Figure 5-7: Trends in Flame & Moth Waste Rock Field Barrel pH, Sulphate, Alkalinity and Acidity Levels

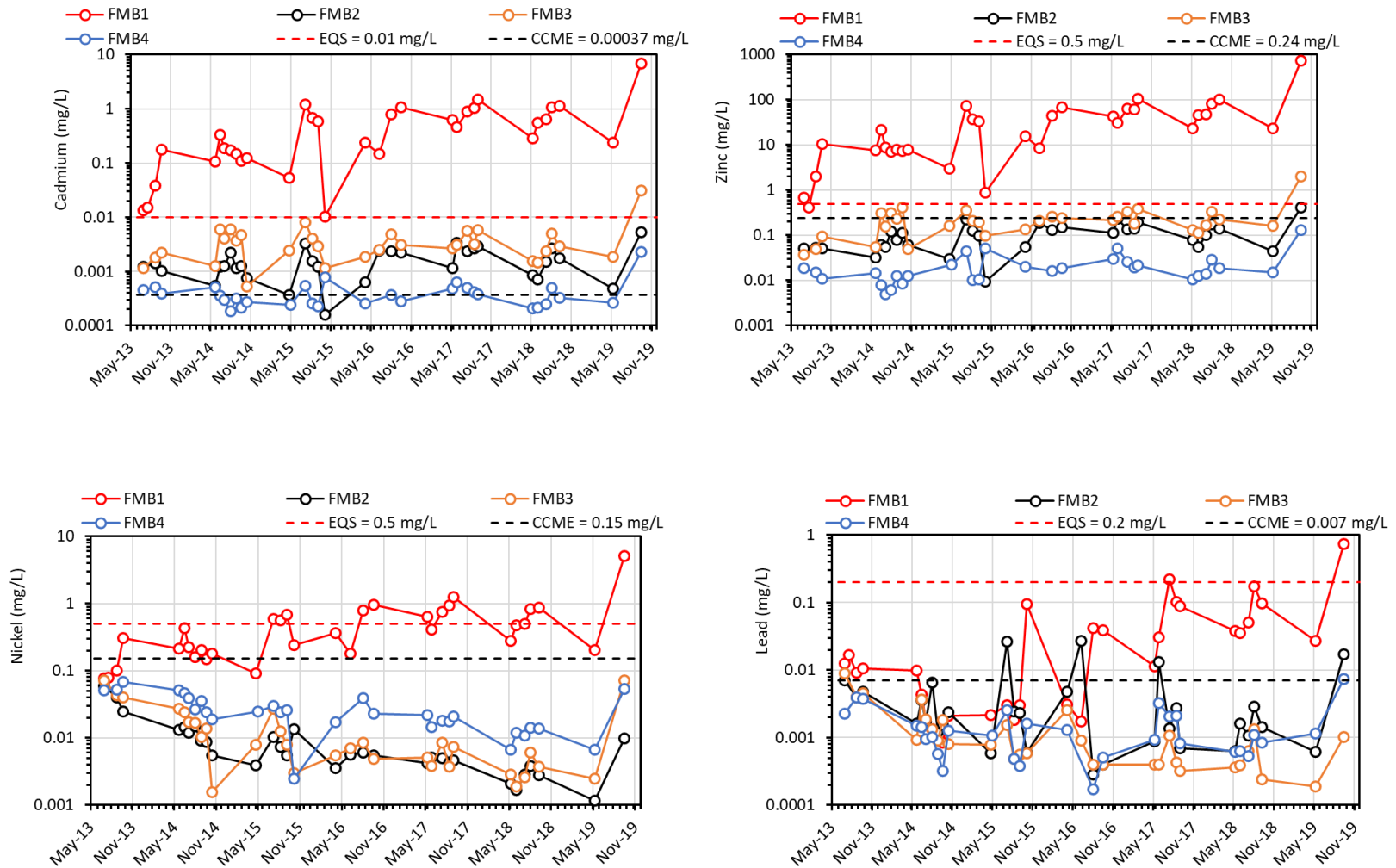

Figure 5-8: Trends in Flame & Moth Waste Rock Field Barrel Cadmium, Zinc, Nickel, and Lead Concentration

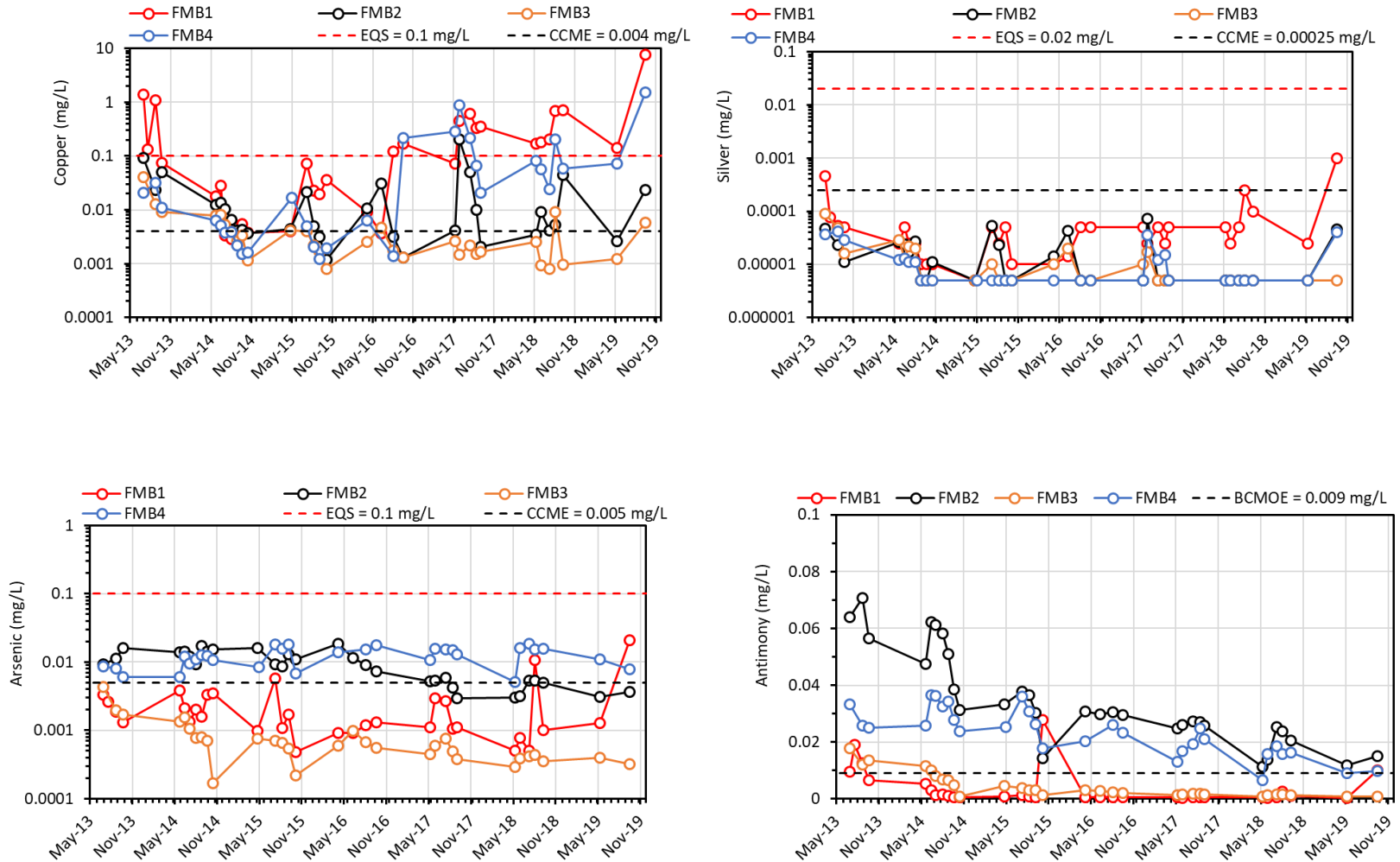

Figure 5-9: Trends in Flame & Moth Waste Rock Field Barrel Copper, Silver, Arsenic, and Antimony Concentrations

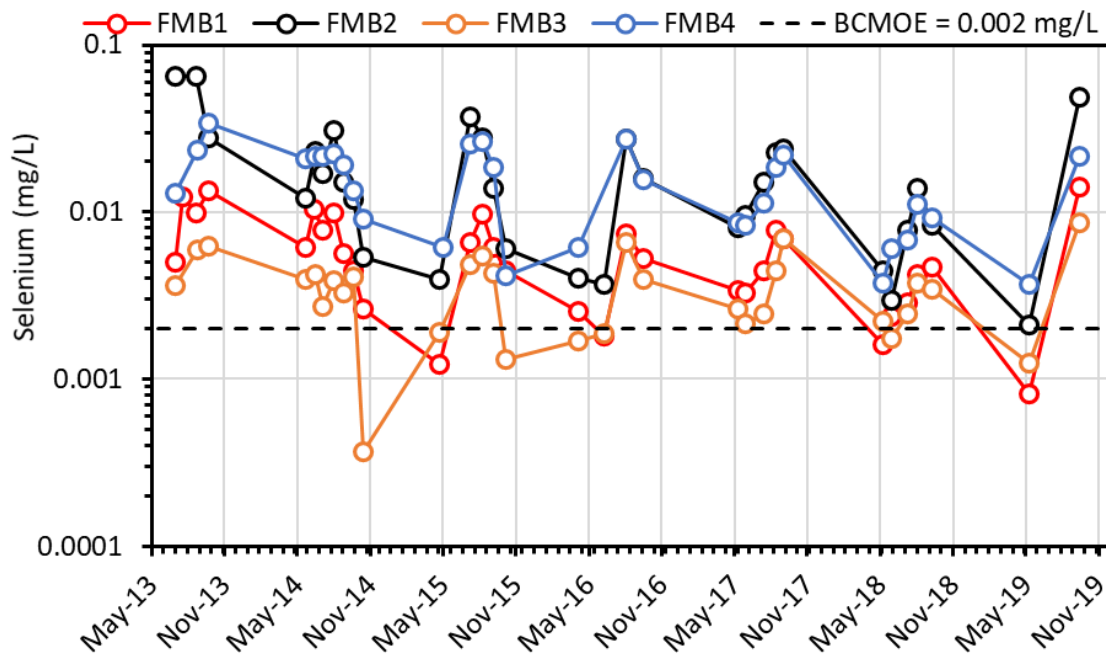

Figure 5-10: Trends in Flame & Moth Waste Rock Field Barrel Selenium Concentrations

6 SUMMARY

- Waste rock generated from deposits of interest within the KHSD is expected to be predominantly non-acid generating. Only waste rock from Silver King and Birmingham is expected to have a sizeable (68% and 29 %, respectively) PAG component, perhaps reflecting a regional control on waste rock ARD potential;
- SFE test suggested elevated soluble concentrations of fluoride, aluminum, antimony, arsenic, and selenium and potential exceedances of the CCME and BC MOE guidelines. Antimony predominantly exceed in samples from Flame & Moth, while the exceedances of arsenic were more recurrent at Birmingham;
- Humidity cell testing indicated higher pH and higher concentration release from the Flame & Moth compared to Birmingham waste rock cells except for arsenic (first 20 cycles only), antimony and cadmium with only antimony and selenium potentially exceeding the generic guidelines during early flushing events. Unlike HC-01, the high sulphur Birmingham cell HC-03 exceeded the sulphate released from the Flame & Moth after 5 months of testing then declined to half of Flame & Moth during the last cycles.
- Field kinetic testing of N-AML waste rock indicated that long-term metal leaching was expected to be low, although antimony, arsenic and selenium concentrations in leachate from some Flame & Moth N-

AML field barrels exceeded CCME and BCMOE guidelines by up to an order of magnitude. On the other hand, P-AML waste rock is expected to release elevated acidity and concentrations of sulphate, cadmium, nickel, lead, copper and zinc in excess of water quality guidelines. Abnormally elevated leachate acidity, sulphate, and metal concentrations were observed in most of the field barrels, especially in P-AML FMB1, for the September 2019 sampling event. This is a sporadic release likely due to poor flushing conditions during this dry year resulting in the storage of weathering products in the barrels following the May 2019 sampling event and their subsequent flushing in September.

7 REFERENCES

- Access Consulting Group (ACG) (2011a). Geochemical Rock Characterization, Onek. Memorandum prepared for Alexco Keno Hill Mining Corp., December 2011.
- Access Consulting Group (ACG) (2011b). Geochemical Rock Characterization, Lucky Queen, Keno Hill District, Yukon. Memorandum prepared for Alexco Keno Hill Mining Corp., December, 2011.
- Access Consulting Group (ACG) (2011c). Preliminary Geoenvironmental Rock Characterization, Silver King. Memorandum prepared for Alexco Keno Hill Mining Corp., August, 2011.
- Alexco Environmental Group Inc. (AEG) (2016a). Environmental Conditions Report, Keno Hill Silver District. Report prepared for Elsa Reclamation and Development Company, June 2016.
- Alexco Environmental Group Inc. (AEG) (2016b). Geochemical Rock Characterization, Flame & Moth Project, Keno Hill District, Yukon. Report prepared for Alexco Keno Hill Mining Corp. March 4, 2016.
- Alexco Environmental Group Inc. (AEG) (2018). Bermingham Waste Rock Geochemical Characterization. Report prepared for Alexco Keno Hill Mining Corp. October 31, 2018.
- Altura Environmental Consulting (2008a). Geoenvironmental Rock Characterization, Bellekeno Zone. Report prepared for Access Consulting Group, January 8, 2008.
- British Columbia Ministry of Environment (BCMoE) (2016) British Columbia Approved Water Quality Guidelines: Aquatic Life, Wildlife & Agriculture. Summary Report. Water Protection & Sustainability Branch, Ministry of Environment, March 2016.
- Canadian Council of Ministers of the Environment (CCME) (2017) Canadian Water Quality Guidelines for the Protection of Aquatic Life. Accessed at <http://st-ts.ccme.ca/>, September 2017.
- CRC (2005) *Handbook of Chemistry and Physics, 85th Edition*. CRC Press. Boca Raton, Florida.
- Minnow Environmental Inc. (2015) Draft Memorandum: Proposed Water Quality Goals for United Keno Hill Complex Watersheds. February 23, 2015.
- Price, W. (2009). Prediction Manual for Drainage Chemistry from Sulphidic Geologic Materials. MEND Report 1.20.1. CANMET – Mining and Mineral Science Laboratories, Smithers, BC.
- Roscoe Postle and Associates Inc. (2017). Technical Report Preliminary Economic Assessment of the Keno Hill Silver District Project, Yukon Territory, Canada.
- Skousen, J., Renton, J., Brown, H., Evans, P., Leavitt, B., Brady, K., Cohen, L. and Ziemkiewicz (1997) Neutralization Potential of Overburden Samples Containing Siderite. *Journal of Environmental Quality*, 26, 673-681.

APPENDIX B

REVIEW OF NET ACID GENERATION AND METAL LEACHING CONTROLLING AND CORRELATING FACTORS - KENO HILL SILVER DISTRICT

Memorandum

To: Brad Thrall, Alexco Keno Hill Mining Corp.

From: Ethan Allen and Kai Woloshyn

CC: Scott Davidson

Date: November 15, 2012

Re: Review of Net Acid Generation and Metal Leaching Controlling and Correlating Factors – Keno Hill District

1 INTRODUCTION

Criteria for Alexco Keno Hill Mining Corporation's (AHKM) waste rock management plan (WRMP) was derived primarily from analysis of Keno Hill District (KHD) static testing results by Altura Environmental Consulting Inc. (Altura 2008a) and geoenvironmental characterization of the Bellekeno deposit also by Altura, (2008b). These studies were used to derive geochemical and field screening criteria to distinguish between rock with the potential to generate net acidity or metal leaching (P-AML) and rocks with low potential for generating net acidity or metal leaching (N-AML).

During AHKM's Lucky Queen-Onek new mine permitting YESAB assessment 2011-0315, Ecometrix Inc. (2012) suggested that "AKHM evaluate the risk of using N-AML waste rock with elevated zinc content as construction and upgrade materials and establish appropriate mitigation measures for the use of these materials near waterways, criteria for use may include factors such as a zinc content limit or minimum distance requirement from surface water."

The purpose of this review is to re-examine correlating and controlling factors for net acid generation and metal leaching (AML) in the KHD and assist with selection of a more stringent criteria for waste rock from development with elevated zinc concentrations to be used for infrastructure construction near water bodies (e.g. road construction at creek crossings).

2 METHODS

Thresholds for metal leaching of zinc and lead in Altura (2008a) were based on the distribution of samples of 24-hour shake flask extraction (SFE) testing results of 47 samples from district wide historical waste rock and pit dumps. Criteria of 10 mg/kg Zn and 3 mg/kg Pb were selected based on the logarithmic distribution plots and horizontal inflection points which indicated division between populations of samples which showed higher and lower metal leaching.

In addition to the 47 samples used by Altura (2008a), additional static testing data from SRK, 2012 (78 samples) and Access Consulting Group (ACCESS, 2012), 40 samples for a total of 165 samples were used in this

study. The 78 samples analyzed reported by SRK (2012) reported results after 18 hours. The remaining data used 24 hour shake flask extraction. Deionized water as the extracting fluid and used a 3:1 liquid to solids ratio. Corresponding ICP metals data by ICP-MS or ICP-OES was used for each sample. ABA data was also available for most samples but was not used in the analysis.

3 RESULTS

Prior to combining the data, 18 hour SFE test results for selected parameters of interest were compared with the 24 hour tests in order to determine if there was any significant increase in dissolution and apparently leachability in the 24 hour tests. Box plots comparing 18 hour and 24 hour test results for calcium, lead and zinc leaching are presented in Figure 1. Median values for all of these parameters are similar to, or greater in the 18 hour tests. This indicates that the additional time does not increase leachability, and that the test results are comparable.

Fresh samples (N =29) were compared with weathered samples (N= 136) in order to determine if fresh samples contained higher contained calcium, as Altura (2008b) adjusted the calcium criteria by a factor of 1.5 since correlation factors were derived using weathered rock while the waste rock management plan was implemented for fresh rock. Figure 2 shows that fresh samples contain significantly more calcium than weathered samples.

3.1 SAMPLE REACTIVITY CRITERIA

Following the methodology of Altura (2008a), the leachate extraction dataset was examined to determine levels of leachate pH, Zn loading and Pb loading that serve to divide populations and determine potential alternative, more conservative population breaks existed from those used by Altura (2008a). Figure 2 through Figure 5 in Attachment 1 show histograms and cumulative distribution plots for leachate pH and leachate concentration (converted to mg/kg) for zinc, lead and cadmium.

Net Acidity: Leachate pH criteria of <5.5 was selected by Altura (2008a) to differentiate samples generating net acidity. Although the additional data presented in Figure 3 do not show two distinct populations, pH 5.5 is located at the edge of a horizontal inflection point in the cumulative relative frequency curve. These results confirm that the leachate pH criteria of <5.5 is appropriate for differentiating the samples generating net acidity.

Metal Leaching: Altura (2008a) used 10 mg/kg zinc and 3 mg/kg lead as the criteria for metal leaching based on logarithmic distribution plots. The additional data presented in Figure 3 result in a less clear division in populations than was found by Altura (2008a). However, a distinct inflection point still exists between 2 and 3 mg/kg on the cumulative distribution plot, indicating that 3 mg/kg is still appropriate for dividing populations between low and high lead leaching.

Figure 5 shows that the additional data still indicate an inflection point at 10 mg/kg leachable zinc. Another inflection point exists at 2 mg/kg. 2 mg/kg is chosen as a second, more conservative threshold to distinguish between populations and can be used to determine a lower contained zinc threshold for waste rock to be used for construction near water courses.

3.2 REVIEW OF KEY CONTROLLING AND CORRELATING FACTORS FOR SAMPLE REACTIVITY

Contained calcium and sulphur via trace metals ICP are plotted in Figure 6 and Figure 7 with color as leachate pH and leachate dissolved zinc, respectively. Color gradient inflection points were chosen to be the same as those used by Altura (2008a) for ease of comparison. Figure 6 shows that the upper left quadrant bound by 0.25% sulphur and 0.51% contains the majority of samples with leachate pH below 5. This quadrant also contains a number of samples with pH > 5.5. The threshold for calcium was increased to 0.75% by Altura (2008b) for application to waste rock management criteria in order to account for the difference between the weathered rock (on which the ARD/ML study was based on) and fresh rock, which contains more calcium. The expanded dataset includes both weathered and fresh rock samples. Figure 7 shows that samples with zinc leaching greater than 2 mg/kg are largely constrained to samples with greater than 0.25% sulphur and less than 0.75% calcium. 9 of 79 samples with < 0.25% S and > 0.51% Ca showed zinc leaching above 1 mg/kg, with 3 of samples greater than 10 mg/kg. Of these samples, 7 had contained zinc of greater than 1100 ppm.

Figure 8 shows leachable zinc versus contained zinc with color gradient as leachate pH. Criteria of 10 mg/kg (Altura, 2008a) and 2 mg/kg ppm zinc are shown with corresponding cut-offs of 5000 and 1100 ppm zinc. As can be seen in Figure 8, 9 samples with contained zinc of between 5000 and 1100 ppm with pH > 5.5 exhibit zinc leaching of greater than 10 mg/kg with one sample reaching 224.1 mg/kg. Reducing the zinc criteria to 1100 ppm eliminates all but one sample with pH > 5.5 which shows zinc leaching of greater than 2 mg/kg.

Figure 9 shows that a cut-off of 5000 ppm eliminates all samples with leachable lead of >3 mg/kg and pH < 5.5. A number of samples (16) exhibit pH < 5.5 but do not show lead leaching over 3 mg/kg.

In summary, key controlling and correlating factors for sample reactivity derived by Altura to identify samples with the potential for generating net acidity (pH > 5.5) remain accurate when including the additional data. Derived ICP criteria of 5000 ppm lead were accurate for identifying samples with elevated leachable lead of >3 mg/kg for the additional data. The derived ICP criteria of 5000 ppm zinc was largely accurate but did not identify all samples with neutral pH and leachable zinc of <10 mg/kg zinc (9 samples with leachable zinc >10 mg/kg vs. 101 samples <10 mg/kg).

A lower zinc cutoff of 1100 ppm resulted in selection of all samples below 2 mg/kg zinc leaching with pH > 5.5 except for one sample which showed 3.15 mg/kg leachable zinc. This lower contained zinc threshold is recommended where selective identification of rock with ultra-low leachable zinc is desirable, i.e. for construction near water bodies.

4 INPUT TERMS FOR MASS LOADING MODELS

GoldSim mass loading modelling has been completed for the Christal Creek and Lightning Creek watersheds. The predictive modeling has included the proposed deposition of N-AML waste rock from Bellekeno, Onek and Lucky Queen. The potential metal leaching load for the contaminants of concern, cadmium and zinc, from the N-AML waste rock was calculated using 50% of the Waste Rock Management Plan N-AML metal leaching criteria thresholds (10 mg zinc /kg waste rock and 1.1 mg cadmium /kg waste rock). This approach is an overly conservative estimation in metal leaching the mean capability for N-AML waste rock for cadmium and zinc. Table 1 provides summary statistics for N-AML waste rock in the KHSD.

In addition, geochemical data sets tend to be positively skewed (Scott and Pain, 2008) which can result in the highest (threshold) value in being orders of magnitude higher than the median or geometric mean. With a

positively skewed data set, half the threshold value is also likely to be significantly higher than the median or geometric mean value.

In order to come up with more representative terms for potential loading from waste rock, the data were filtered as per the waste rock management plan for Bellekeno and Onek for all of the geochemical thresholds (screening criteria) as above. With the samples filtered for these criteria, 75 of 165 were selected. Summary statistics for this subset are shown in Table 1 below:

Table 1: Summary statistics for key parameters, filtered as N-AML

Statistic	LCH_Pb (mg/kg)	LCH_Zn (mg/kg)	LCH_Cd (mg/kg)	Pb (ppm)	Zn (ppm)	Cd (ppm)	Ca (%)	S (%)
No. of observations	75	75	75	75	75	75	75	75
Minimum	0.000	0.009	0.0000	1.000	11.000	0.050	0.020	0.010
Maximum	1.626	224.100	5.4300	3506.370	3221.700	55.140	8.320	1.280
1st Quartile	0.001	0.014	0.0002	9.450	108.500	0.300	0.085	0.020
Median	0.007	0.030	0.0013	79.000	276.000	2.900	0.970	0.050
3rd Quartile	0.058	0.254	0.0181	674.500	596.800	9.300	2.470	0.230
Mean	0.090	3.974	0.1133	519.038	509.384	7.251	1.920	0.179
Variance (n-1)	0.058	685.897	0.4246	727183	504541	110	5.858	0.064
Standard deviation (n-1)	0.242	26.190	0.6516	852.751	710.311	10.477	2.420	0.253
Skewness (Pearson)	4.510	8.106	7.5552	2.104	2.550	2.391	1.431	1.993
Skewness (Fisher)	4.603	8.272	7.7102	2.147	2.602	2.440	1.460	2.034
Skewness (Bowley)	0.789	0.863	0.8667	0.791	0.314	0.422	0.258	0.714
Geometric mean	0.009	0.071	0.0015	79.268	228.024	1.989	0.562	0.070

As can be seen in Table 1, after filtering the dataset according to the waste rock management plan geochemical screening criteria, for N-AML samples, the maximum value for leachable zinc is 224.1mg/kg while the median is 0.036 mg/kg and the geometric mean is 0.075 mg/kg, or approximately 4 orders of magnitude apart. The geometric mean for leachable cadmium is 0.0015 and the median is 0.0013 for this subset. It is suggested that the geometric mean might be more appropriate for a realistic estimate of potential N-AML waste rock pore water concentration. Significant positive skewness is noted for all parameters but particularly leachable lead, cadmium and zinc.

Filtering the data according to the waste rock management plan geochemical screening criteria but with the zinc threshold of 1100 ppm results in 67 of 165 samples selected. Summary statistics for this subset are shown in Table 2:

Table 2: Summary statistics for key parameters, filtered as N-AML and samples <1100 ppm zinc

Statistic	LCH_Pb (mg/kg)	LCH_Zn (mg/kg)	LCH_Cd (mg/kg)	Pb (ppm)	Zn (ppm)	Cd (ppm)	Ca (%)	S (%)
No. of observations	67	67	67	67	67	67	67	67
Minimum	0.000	0.009	0.0000	1.000	11.000	0.050	0.020	0.010
Maximum	1.626	38.100	1.6200	3506.370	1100.000	27.430	8.320	0.710
1st Quartile	0.001	0.011	0.0002	7.450	100.500	0.265	0.070	0.020
Median	0.006	0.030	0.0008	48.000	182.000	2.000	0.810	0.040
3rd Quartile	0.042	0.134	0.0072	530.450	439.500	7.650	2.470	0.175
Mean	0.089	0.894	0.0406	439.827	299.700	4.673	1.898	0.133
Variance (n-1)	0.064	23.094	0.0415	681547	71341	36.078	6.258	0.032
Standard deviation (n-1)	0.254	4.806	0.2036	825.559	267.097	6.006	2.502	0.178
Skewness (Pearson)	4.390	7.204	7.2132	2.413	1.025	1.750	1.417	1.713
Skewness (Fisher)	4.492	7.370	7.3795	2.469	1.049	1.790	1.450	1.752
Skewness (Bowley)	0.758	0.683	0.8167	0.845	0.519	0.530	0.383	0.742
Geometric mean	0.007	0.051	0.0010	58.646	174.765	1.465	0.492	0.058

Using the geochemical screening criteria in the waste rock management plan with a lower zinc cutoff of 1100 ppm results in a maximum value of 38.1 mg/kg leachable zinc with a median value of 0.03 mg/kg and geometric mean value of 0.051 mg/kg zinc. The geometric mean for leachable cadmium is 0.001 and the median is 0.0008 for this subset.

5 CONCLUSIONS

- Leachate pH of <5.5 is appropriate for differentiating samples generating net acidity although a significant proportion of samples with >0.25% S and <0.75% Ca do not demonstrate pH < 5.5
- Sample reactivity criteria for lead leaching of 3 mg/kg is indicated by the distribution of samples and corresponds well with a contained lead content of 5000 ppm, excluding samples with pH < 5.5
- Sample reactivity criteria for zinc leaching of 10 mg/kg is indicated by the distribution of samples. A second inflection point at 2 mg/kg can be used to derive a more conservative criterion for zinc. The contained zinc threshold >5000 ppm identifies most samples with pH >5.5 having leachable zinc of >10 mg/kg. However, approximately 10% of the samples with <5000 ppm and pH >5.5 show zinc leaching above 10 mg/kg. The lower contained zinc threshold of >1100 ppm identifies all but one sample with pH >5.5 above 2 mg/kg leachable zinc.
- Modified waste rock management geochemical criteria with a lower contained zinc threshold of <1100 ppm is recommended to select waste rock to be used near (within 30m) of a water course. This corresponds with a field screening criterion of 0.165% sphalerite (trace to no visible sphalerite is recommended). If waste rock from Lucky Queen is selected for construction near a water course, specific waste rock management criteria derived for Lucky Queen (Access, 2011b) are recommended.

Lucky Queen waste rock management criteria differ in that a lower sulphur criterion of 0.15% is used because available neutralizing potential is lower at Lucky Queen.

- The use of the geometric mean values for samples filtered according to all criteria of the geochemical screening criteria is recommended for calculating a representative or realistic estimate of potential concentrations and metal loads from N-AML waste rock disposal areas.

References:

- Access (2011a). Geochemical Rock Characterization, Lucky Queen. Memorandum prepared for Alexco Keno Hill Mining Corp, December 2011.
- Access Consulting Group (2011a). Geochemical Rock Characterization, Onek. Memorandum prepared for Alexco Keno Hill Mining Corp, December 2011.
- Altura Environmental Consulting (2008a). Review of Historic Keno Static Test Data to Define ARD/ML – Controlling and Correlating Factors. Letter report prepared for Access Consulting Group, January 4, 2008.
- Altura Environmental Consulting (2008b). Geoenvironmental Rock Characterization, Bellekeno Zone. Letter report prepared for Access Consulting Group, January 8, 2008.
- Ecometrix (2012) Lucky Queen and Onek Deposit Production Project – Review of Effects on Aquatic Resources. Report prepared for Yukon Environmental and Socio-economic Assessment Board Mayo Designated Office, July 2012.
- Scott, K.M., Pain, C.F. (2008). *Regolith Science*. Springer. Collingwood, Australia.
- SRK Consulting Canada Inc. (2012). Supplemental Waste Rock Characterization. Memorandum prepared for Access Consulting Group, April 25, 2012

Attachments:

Attachment 1: Figures



ATTACHMENT 1

FIGURES

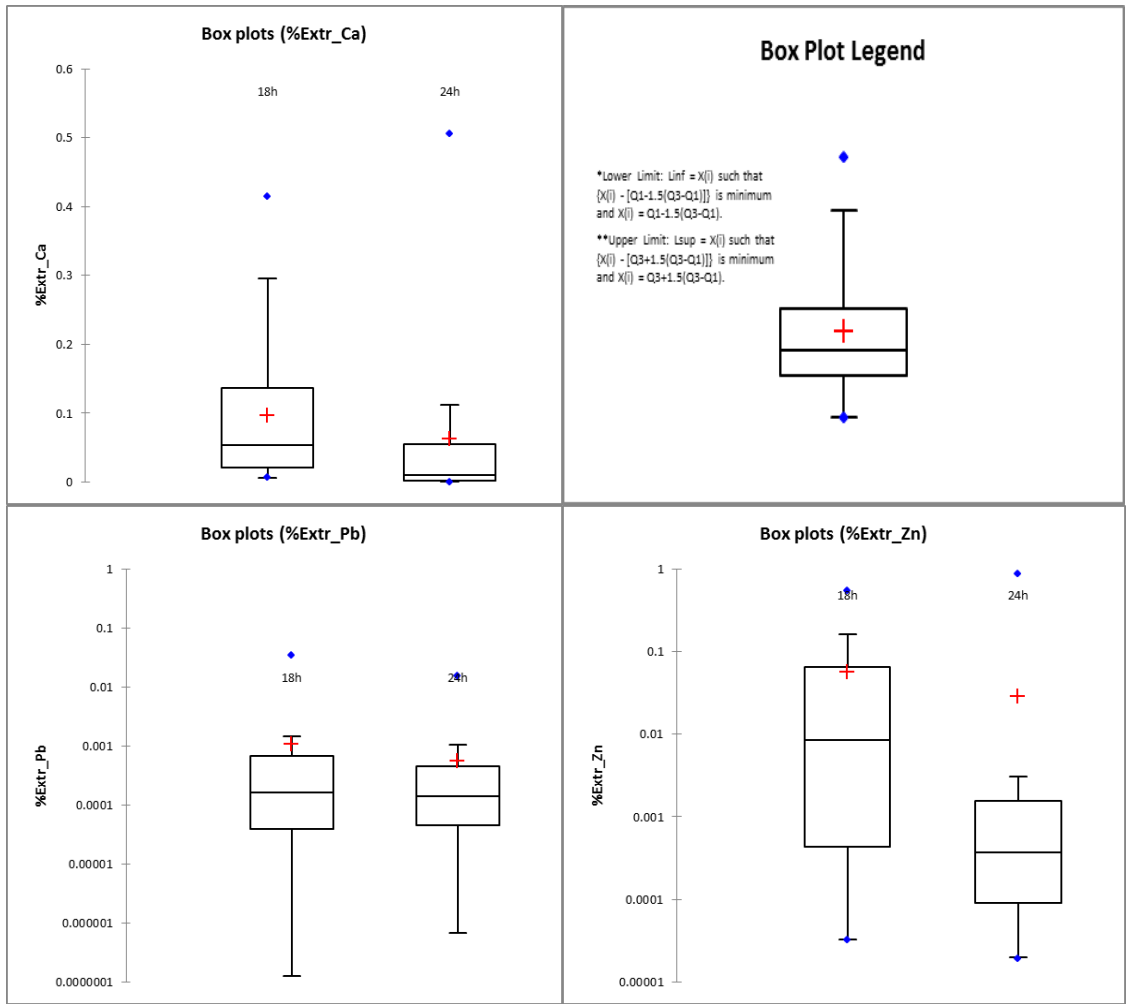

Figure 1: Percent extraction for select parameters, 18 hour vs. 24 hour shake flask extraction tests

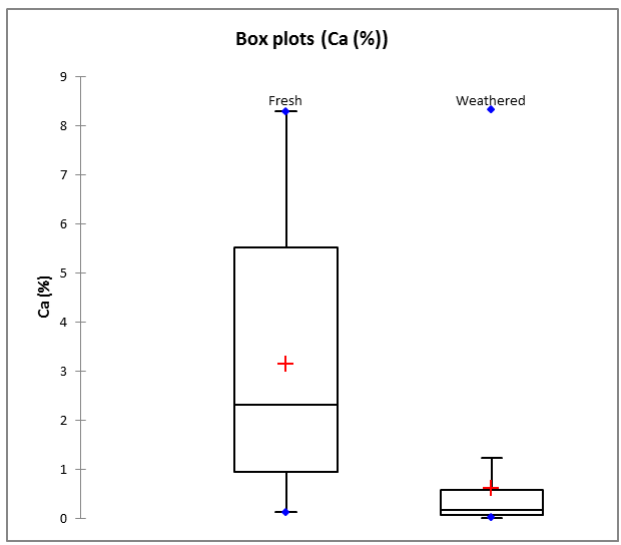

Figure 2: Contained calcium in fresh vs. weathered samples

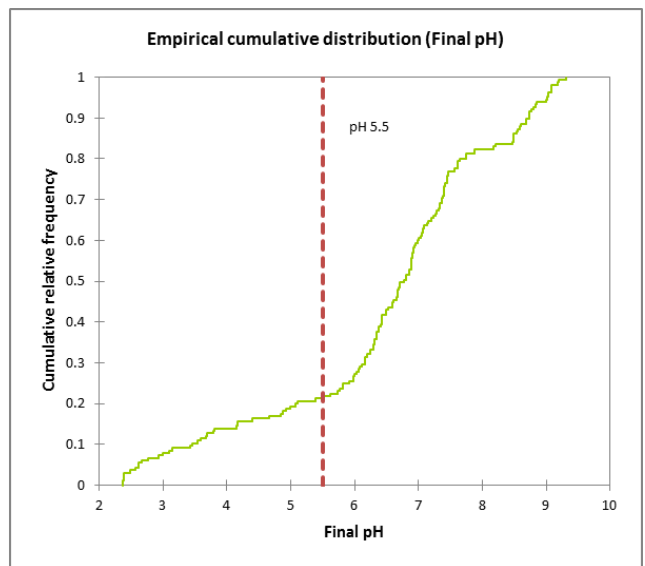
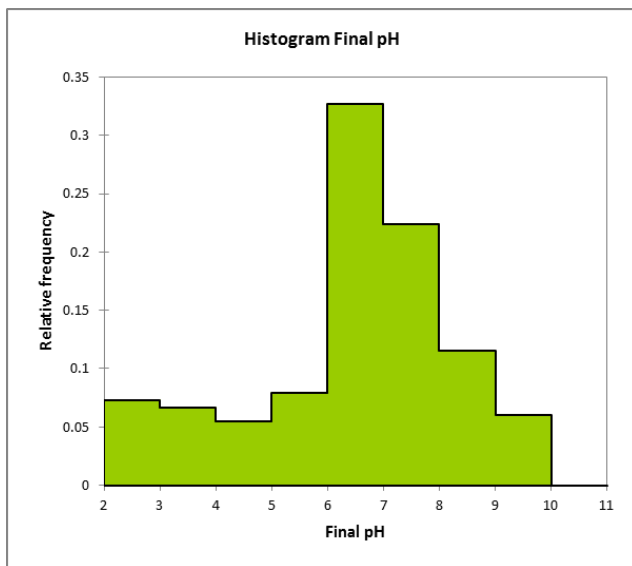

Figure 3: Histograms and cumulative distribution curve for pH

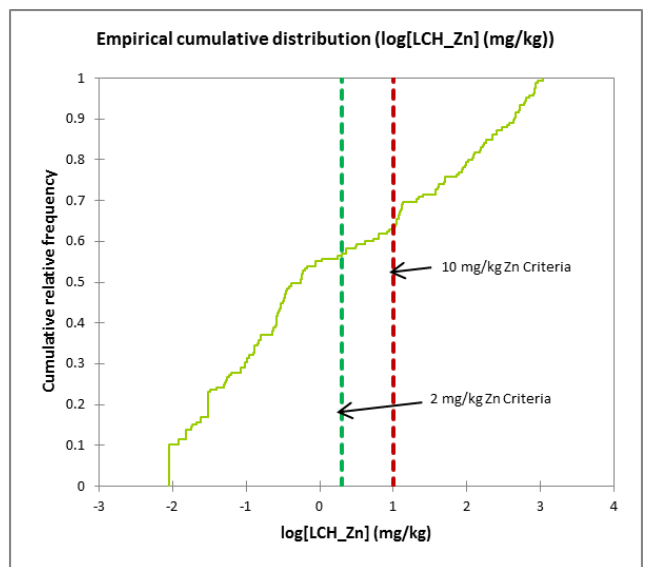
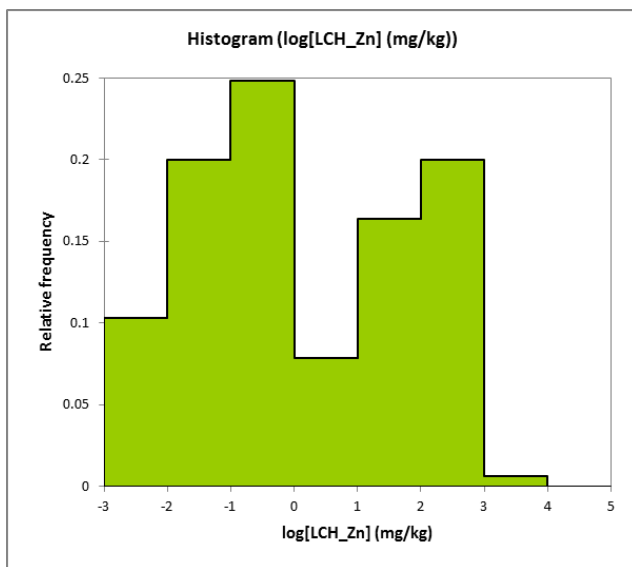

Figure 4: Histograms and cumulative distribution curve for leachable zinc

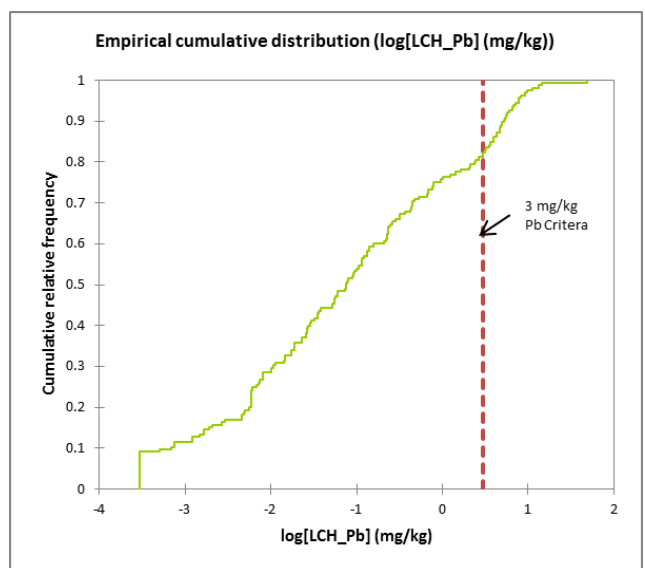
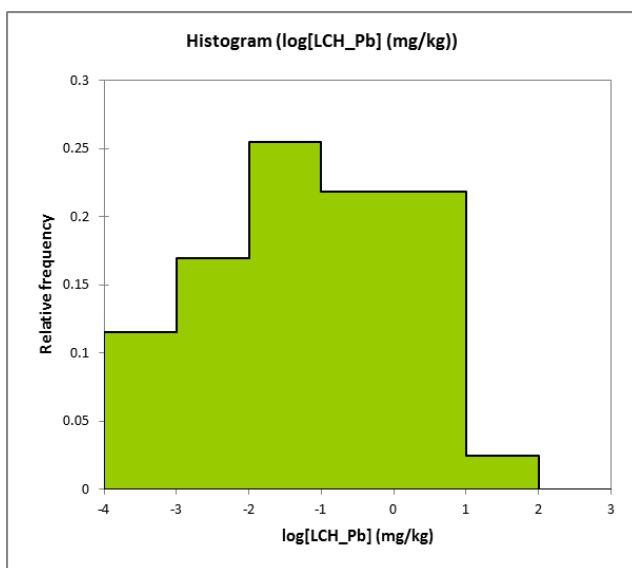

Figure 5: Histograms and cumulative distribution curve for leachable lead

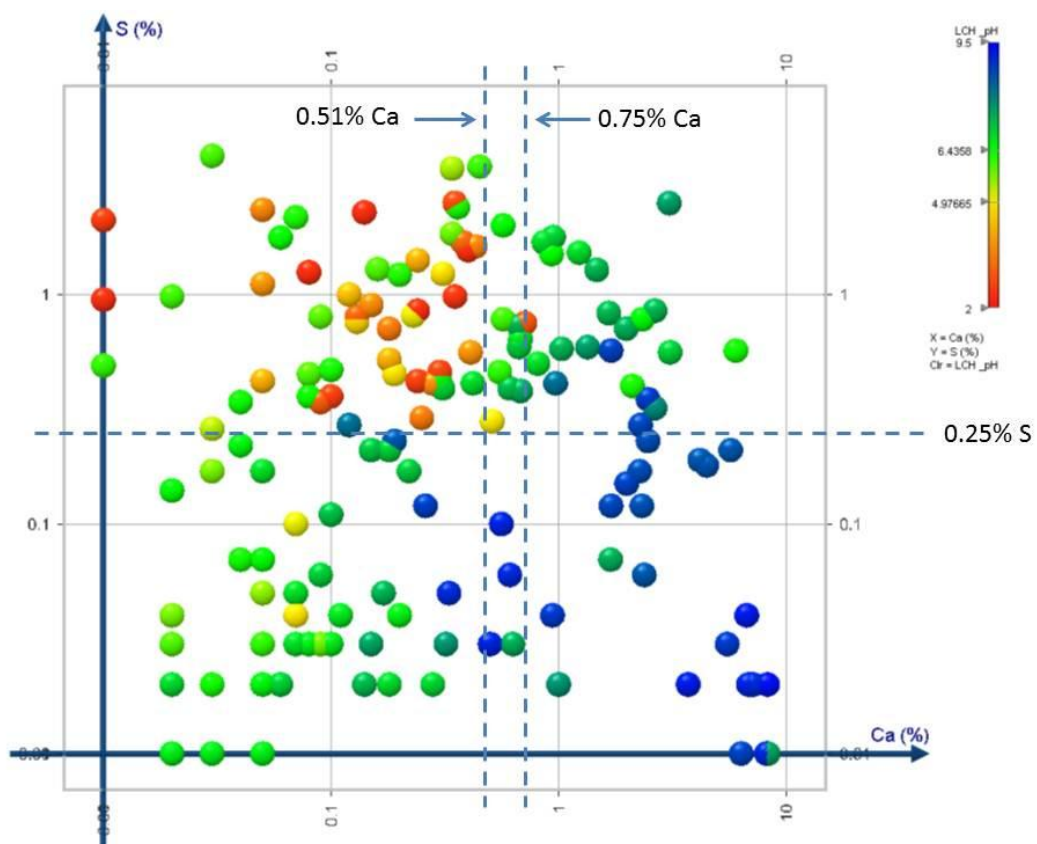

Figure 6: Calcium vs Sulphur rock analyses with leachate pH color gradient

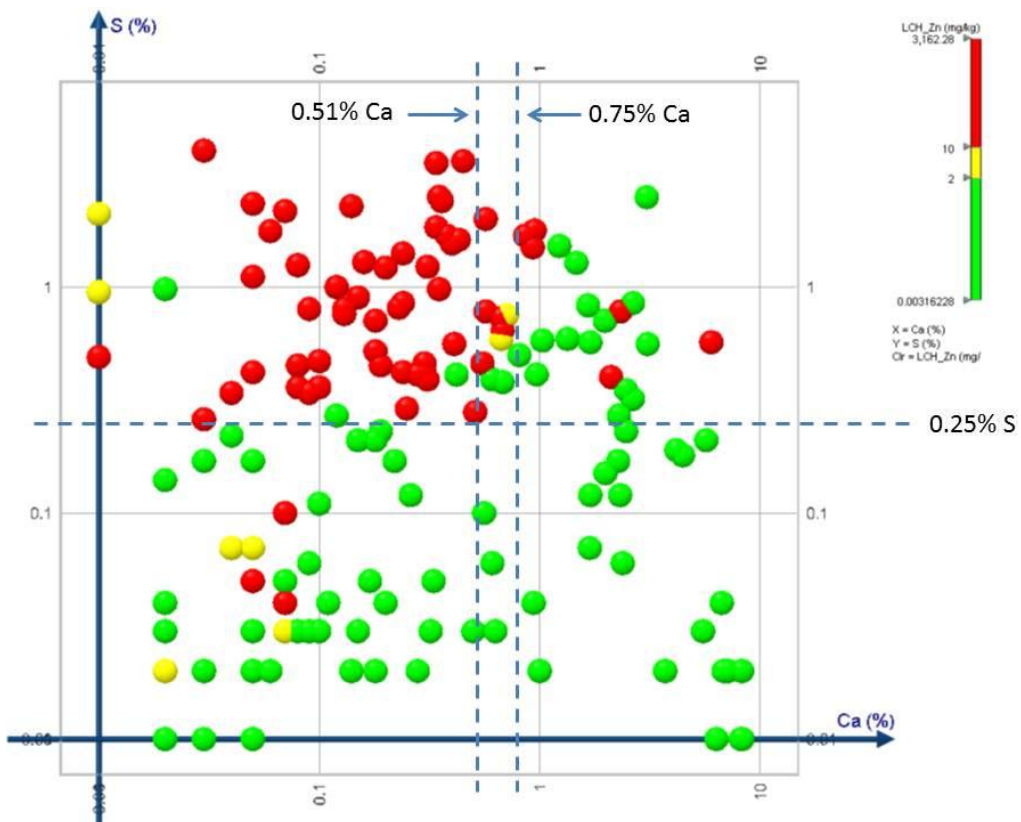

Figure 7: Calcium vs Sulphur rock analyses with leachate dissolved zinc as color interval

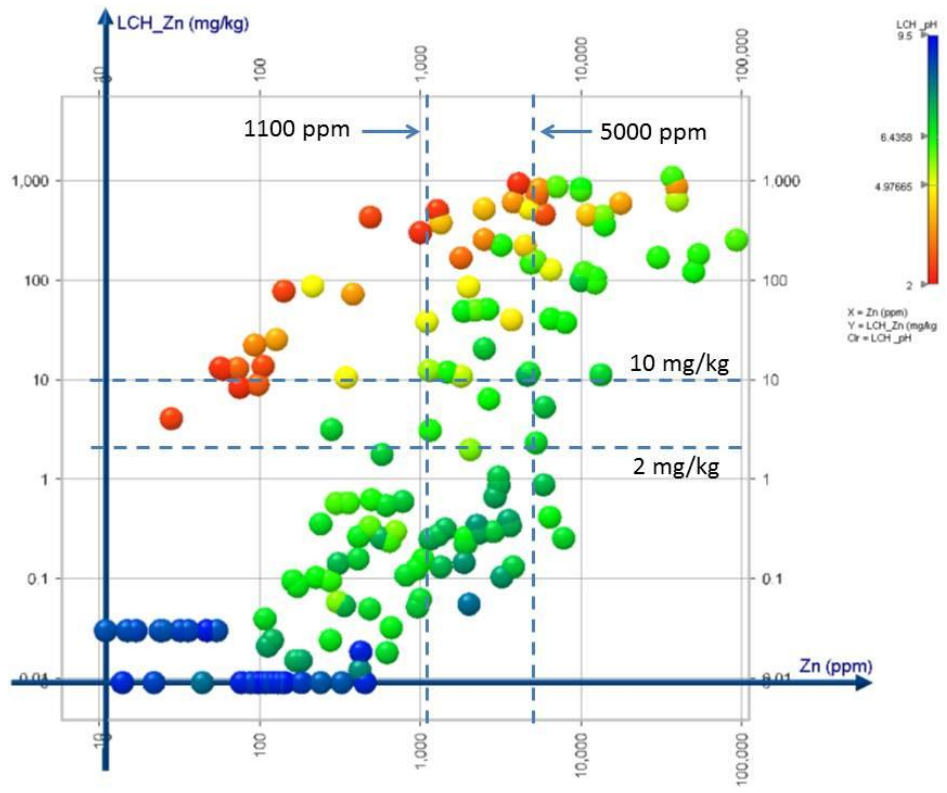

Figure 8: Leachate dissolved zinc vs. contained zinc with leachate pH as color gradient

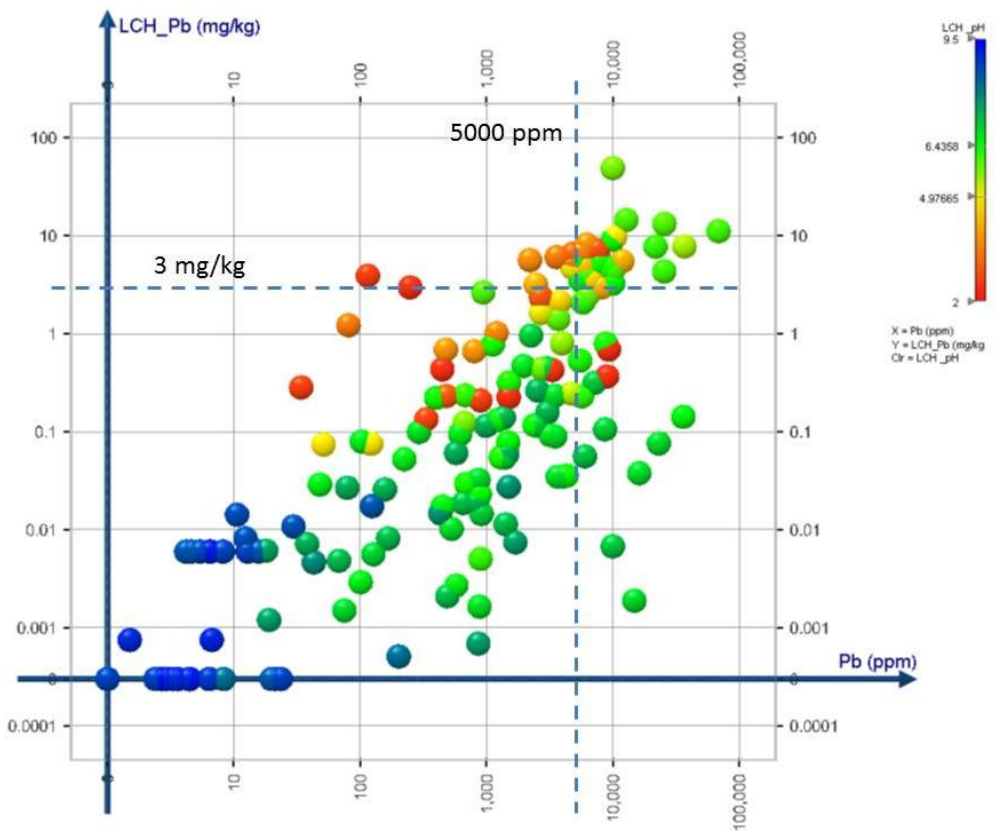

Figure 9: Leachate dissolved lead vs. contained lead with leachate pH as color gradient

APPENDIX C

**TYPICAL WASTE CONTAINMENT FACILITY DESIGN, KENO HILL SILVER
DISTRICT, YT, CONSTRUCTION SPECIFICATIONS, ISSUED FOR USE**

Alexco Resource Canada Corp.

TYPICAL WASTE CONTAINMENT FACILITY DESIGN
KENO HILL SILVER DISTRICT, YT
CONSTRUCTION SPECIFICATIONS
ISSUED FOR USE

W14101142

July 2008





TABLE OF CONTENTS

<u>Section</u>		<u>Number of Pages</u>
Section 1001	Definitions	1
Section 1002	General	2
Section 1003	Fill Materials	2
Section 1004	Fill Placement	2
Section 1005	Liner System	11
Section 1006	Quality Assurance	5
Section 1007	Design Alternatives	2
Section 1008	Operation and Maintenance	2





APPENDICES

Appendix A Construction Drawings



Section 1001

DEFINITIONS

DEFINITIONS

1.0□ General

- .1 Definitions of terms used throughout the Construction Specifications are presented in this Section.

2.0□ Definitions

Construction Drawings:	the drawings, as issued for construction, of the Typical Waste Containment Facility Design.
Construction Specifications:	this document.
Contract:	the legal and binding agreement between the Contractor and Alexco Resource Corp. regarding construction of the Waste Containment Facility.
Contractor:	the general contractor responsible for constructing the Waste Containment Facility.
Engineer:	the Professional Geotechnical Engineer registered in the Yukon who is associated with the construction process.
Owner:	Alexco Resource Corp.
Site:	the area in which construction of the Waste Containment Facility or related activity is occurring.
Unsuitable:	not meeting the requirements stated herein or not receiving the Engineer's approval.
Facility:	all components of the Waste Containment Facility.

END OF SECTION



Section 1002

GENERAL

GENERAL

1.0 □ General

- .1 Alexco Resource Canada Corp. intends to construct a containment facility to store waste rock from the Bellekeno advanced underground exploration and development program. As the company advances through the Keno Hill Silver District, it is anticipated further underground exploration and development programs will require similar containment facilities. Therefore, a typical design has been developed to account for the various potential site and construction material conditions.
- .2 The Facility is to be located within previously disturbed areas, all of which will be incorporated within a district wide closure plan. This district wide closure plan is required under the water license QZ06-074.
- .3 Site specific conditions and Facility location have not been provided or considered. Once Facility location and site specific conditions are known, they must be reviewed by the Engineer. Furthermore, the base of the Facility must be approved by the Engineer prior to fill placement.
- .4 The Facility will be lined with a suitable geomembrane. Water in the Facility will flow towards the vertical culvert and pond within the voids of the waste material.
- .5 Water in the Facility will be monitored and tested on a regular basis. Based on water quality analysis, the waste water will be extracted via pump truck and discharged to the environment or treated in a designated treatment facility.
- .6 Once the Facility reaches its ultimate capacity, the Facility will be capped and reclaimed.

2.0 □ Scope of Work

- .1 The scope of work for the construction of the Facility is as follows:
 - a. Construct the liner subgrade and berms with Zone B material at the specified grade. This could include cut/fill operations should the foundation material be satisfactory;
 - b. If required, install a geotextile layer to act as separator for Zone A and Zone B materials;
 - c. Construct the liner bedding with Zone A material;

- d. Install the liner system consisting of a suitable liner material and if required, protective geotextile layers above and below the liner, and a geocomposite reinforcing layer;
- e. Place and compact cover material, Zone A material, over the liner system;
- f. Install vertical culvert as specified on the Construction Drawings;
- g. Place and compact the waste material;
- h. Regrade the waste material and place and compact capping material;
- i. Install vegetative cover.

END OF SECTION



Section 1003

FILL MATERIALS

FILL MATERIALS

1.0□ General

- .1 This section describes the construction material specifications for the Waste Containment Facility.

2.0□ Reference Standards

- .1 The most recent copy of American Society for Testing Materials, ASTM C136, Standard Test Method for Sieve Analysis of Fine and Coarse Aggregate.

3.0□ Material Sources

- .1 No material of any type shall be borrowed or excavated without the Owner's prior approval.
- .2 Pits and quarries shall be maintained and managed in accordance with the requirements set out in the Owner's Land Use and Quarry Permits.
- .3 Zone A material shall be obtained from sources approved by the Owner, provided the final product meets the requirements specified herein. Processing may be required to achieve the specified gradation.
- .4 Zone B material shall be obtained from sources approved by the Owner, provided the final product meets the requirements specified herein. Processing may be required to achieve the specified gradation.
- .5 The parent rock from which all fill materials are derived shall consist of sound, hard, durable material free from soft, thin, elongated or laminated particles and shall contain no unsuitable substances. The potential quarry source shall be approved by the Engineer.
- .6 The quarry source for the Facility fill materials shall be inspected by the Engineer throughout material processing to ensure the product meets the requirements stated herein.

4.0 □ Material Specifications

.1 Zone A Material

The Zone A material shall consist of hard, durable particles, shall be free of roots, topsoil, and deleterious material and shall have a particle size distribution, as measured by ASTM C136, as presented in Table 1003.1.

TABLE 1003.1: ZONE A MATERIAL (10 MM MINUS) - PARTICLE SIZE DISTRIBUTION LIMITS

Sieve Size (mm)	% Passing Fine Limit	% Passing Coarse Limit
10	100	100
5	80	100
2	55	100
0.63	25	65
0.25	10	40
0.08	2	15

.2 Zone B Material

The Zone B material shall be free of roots, topsoil and other deleterious material and shall have a particle size distribution within the limits presented in Table 1003.2.

TABLE 1003.2: ZONE B MATERIAL (200 MM MINUS) - PARTICLE SIZE DISTRIBUTION LIMITS

Sieve Size (mm)	% Passing Fine Limit	% Passing Coarse Limit
200	100	100
100	85	100
50	65	100
25	40	100
5	20	55
2	0	20

END OF SECTION



Section 1004

FILL PLACEMENT

FILL PLACEMENT

1.0 □ General

- .1 The fill placement methods to be used during construction of the Waste Containment Facility are described in this Section.
- .2 Construction shall be performed in accordance with the best modern practice and with equipment best adapted to the work being performed. Embankment materials shall be placed so that each zone is homogeneous; free of stratifications; ice chunks, lenses or pockets; and layers of material with different texture grading not conforming to the requirements stated herein.
- .3 No fill material shall be placed on any part of the foundation until it has been prepared, as specified herein. Placement of fill material shall conform to the lines, grades and elevations shown on the Construction Drawings.
- .4 Embankment construction shall not proceed when the work cannot be performed in accordance with the requirements of the Construction Specifications. Any part of the embankment that has been damaged by the action of rain, snow or any other cause shall be removed and replaced with the appropriate material conforming to the requirements stated herein.
- .5 Stockpiling, loading, transporting, placing, and spreading of all materials shall be carried out in such a manner to avoid segregation. Segregated materials shall be removed and replaced with the materials meeting the requirements stated herein.
- .6 The Contractor shall remove all debris, vegetation or any other material not conforming to the requirements stated herein. The Contractor shall dispose of these materials in an area approved by the Owner.

2.0 □ Zone B Material Placement

- .1 The Zone B material shall be placed to the design elevation as specified in the Construction Drawings in lifts no greater than 500 mm in uncompacted thickness.
- .2 The design elevation for the top of the Zone B berm material shall be no less than 0.5 m above original ground.
- .3 Moisture condition and compact using the minimum number of passes established in accordance with section 1006.4.2.

3.0 Zone A Material Placement

- .1 The Zone A material shall be placed as bedding for the liner system (minimum 300 mm thick) to the design grade specified in the Construction Drawings.
- .2 Subsequent to the liner installation, the Zone A material shall be placed as liner system cover material. The liner system cover material shall be placed to the minimum thickness specified in Table 1004.1 dependent on the type of liner selected.

TABLE 1004.1: RECOMMENDED MINIMUM COVER THICKNESSES

Liner Material	Minimum Required Thickness
Enviro Liner® 4040 (Without Geocomposite)	1.3 m
Enviro Liner® 4040 (With Geocomposite)	0.3 m
HDPE 60	0.3 m
PVC 40 (With Geocomposite)	0.3 m

- .3 The Construction Drawings are based on the selection of Enviro Liner® 4040 with the installation of a geocomposite reinforcing material. Other design alternatives are detailed in Section 1007.
- .4 Zone A material shall be placed in lifts not exceeding 300 mm in uncompacted thickness. Vehicle traffic is prohibited from maneuvering within the Facility until the cover material has reached the minimum thickness required as specified in Table 1004.1.
- .5 Moisture condition and compact with using the minimum number of passes established in accordance with section 1006.4.1.
- .6 Equipment with ground pressures higher than 380 kPa should not be permitted inside the Facility once the liner system has been placed. Care is required to provide the appropriate thickness of fill beneath a vehicle when placing material above the liner system to ensure it is not damaged. Traffic in the area should be restricted to low ground pressure equipment.

END OF SECTION



Section 1005

LINER SYSTEM

LINER SYSTEM

1.0 □ General

- .1 The product and installation specifications for the non-woven geotextile, liner systems and geocomposite materials to be used in the Waste Containment Facility are presented in this section.
- .2 The liner system will be provided by the Owner and installed by the Contractor.

2.0 □ Reference Standards

- .1 The most recent copy of the following American Society for Testing Materials standards:
 - a. ASTM D638 Standard Methods for Tensile Properties of Plastics.
 - b. ASTM D792 Standard Test Methods for Density and Specific Gravity (Relative Density) of Plastics by Displacement.
 - c. ASTM D1004 Standard Test Methods for Initial Tear Resistance of Plastic Film and Sheeting.
 - d. ASTM D1603 Standard Test Methods for Carbon Black in Olefin Plastics.
 - e. ASTM D1777 Standard Test Methods for Thickness of Textile Materials.
 - f. ASTM D4533 Standard Test Methods for Trapezoidal Tearing Strength of Geotextiles.
 - g. ASTM D4632 Standard Test Methods for Grab Breaking Load and Elongation of Geotextile.
 - h. ASTM D4751 Standard Test Methods for Determining Apparent Opening Size of a Geotextile.

- i. ASTM D4833 Standard Test Methods for Index Puncture Resistance for Geotextile, Geomembranes, and Related Products.
 - j. ASTM D5199 Standard Test Methods for Measuring the Nominal Thickness of Geosynthetics.
 - k. ASTM D5261 Standard Test Methods for Measuring Mass per Unit Area of Geotextiles.
 - l. ASTM D5994 Standard Test Methods for Measuring Core Thickness of textured Geomembranes
- .2 Federal Test Method
- a. FTM Standard 101.

3.0 Materials

.1 Geotextile

- a. The non-woven geotextile shall have a weight of 542 g/m². The manufacturer shall, prior to shipment of materials, provide to the Engineer a signed manufacturing certification that materials to be shipped to site have test values that meet or exceed the requirements listed in Table 1005.1.

TABLE 1005.1: RECOMMENDED MINIMUM GEOTEXTILE PROPERTIES

Physical Property	Minimum Average Roll Value (Weakest Principle Direction)
Thickness – Typical (ASTM D5199)	3.6 mm
Grab Tensile Strength (ASTM D4632)	1690 N
Elongation at Failure (ASTM D4632)	50 %
Trapezoidal Tear Strength (ASTM D4533)	645 N
Puncture (ASTM D4833)	1070 N
Apparent Opening Size (ASTM D4751)	150 microns
Weight – Typical (ASTM D5261)	542 g/m ²

- b. Any visible damage to the shipment of geotextile shall be noted on the freight receipt and project records.
- c. Storage of geotextile rolls on site shall be in a secure location that will minimize exposure to the elements, UV light and physical damage.

.2 Enviro Liner® 4040

- a. The Enviro Liner® shall be 1.0 mm (40 mil) thick geomembrane or equivalent. The manufacturer shall, prior to shipment of materials, provide to the Engineer a signed manufacturing certification that materials to be shipped to site have test values that meet or exceed the requirements listed in Table 1005.2.

TABLE 1005.2: RECOMMENDED MINIMUM GEOMEMBRANE PROPERTIES

Property	Enviro Liner® 4040
Minimum Average Thickness (ASTM D5994)	1.0 mm
Relative Density (ASTM D792)	0.939
Tensile Strength at Yield (ASTM D638)	26.6 N/mm
Elongation at Yield (ASTM D638)	800 %
Tear Resistance (ASTM D1004)	98 N
Puncture Resistance (FTMS 101)	271 N
Carbon Black Content (ASTM D1603)	2.0 – 3.0 %

- b. The liner material supplied under the specifications shall not have any blisters, holes, undispersed raw materials or any signs of contamination or inclusions of foreign matter. Such defects shall be repaired using techniques in accordance with manufacturer's recommendations. Excessive defects may be grounds for rejecting the entire roll of liner.
- c. Storage of geomembrane rolls on site shall be in a secure location that will minimize exposure to the elements and physical damage.
- d. Enviro Liner® geomembrane is suitable for secondary containment of hydrocarbons and other chemicals, and primary containment of water and water based effluents or as approved by manufacturer.

.3 HDPE Liner

- a. The HDPE geomembrane shall be 1.5 mm (60 mil) thick geomembrane or equivalent. The manufacturer shall, prior to shipment of materials, provide to the Engineer a signed manufacturing certification that materials to be shipped to site have test values that meet or exceed the requirements listed in Table 1005.3.

TABLE 1005.3: RECOMMENDED MINIMUM GEOMEMBRANE PROPERTIES

Property	Textured HDPE 60
Minimum Average Thickness (ASTM D5994)	1.5 mm
Relative Density (ASTM D792)	0.94
Tensile Strength at Yield (ASTM D638)	22.0 kN/m
Elongation at Yield (ASTM D638)	12 %
Tear Resistance (ASTM D1004)	187 N
Puncture Resistance (FTMS 101)	480 N
Carbon Black Content (ASTM D1603)	2.0 – 3.0 %

- b. The liner material supplied under the specifications shall not have any blisters, holes, undispersed raw materials or any signs of contamination or inclusions of foreign matter. Such defects shall be repaired using welding techniques in accordance with manufacturer's recommendations. Excessive defects may be grounds for rejecting the entire roll of liner.
- c. Extrusion resin used for extrusion joining of sheets and for repairs should be HDPE from the same resin batch as the sheet resin. Physical properties must be the same as the liner sheets.
- d. HDPE liner is suitable for containment of hydrocarbons and chemicals as well as water and water based effluents or as approved by manufacturer.
- e. Storage of geomembrane rolls on site shall be in a secure location that will minimize exposure to the elements and physical damage.

.4 PVC Liner

- a. The PVC geomembrane shall be 0.95 mm (38 mil) thick geomembrane or equivalent. The manufacturer shall, prior to shipment of materials, provide to the

Engineer a signed manufacturing certification that materials to be shipped to site have test values that meet or exceed the requirements listed in Table 1005.4.

TABLE 1005.4: RECOMMENDED MINIMUM GEOMEMBRANE PROPERTIES

Property	PVC 40
Minimum Average Thickness (ASTM D5994)	0.95 mm
Tensile Strength at Yield (ASTM D638)	17 N/mm
Elongation at Yield (ASTM D638)	430 %
Tear Resistance (ASTM D1004)	44 N

- b. The liner material supplied under the specifications shall not have any blisters, holes, undispersed raw materials or any signs of contamination or inclusions of foreign matter. Such defects shall be repaired using techniques in accordance with manufacturer’s recommendations. Excessive defects may be grounds for rejecting the entire roll of liner.
 - c. PVC liner is suitable for containment of water and water based effluents or as approved by manufacturer. It is not suitable for containment of hydrocarbons.
 - d. Storage of geomembrane rolls on site shall be in a secure location that will minimize exposure to the elements, UV light and physical damage.
- .5 Geocomposite
- a. The geocomposite reinforcing material shall be 5 mm (200 mil) thick or equivalent. The manufacturer shall, prior to shipment of materials, provide to the Engineer a signed manufacturing certification that materials to be shipped to site have test values that meet or exceed the requirements listed in Table 1005.5.

TABLE 1005.5: RECOMMENDED MINIMUM GEOCOMPOSITE PROPERTIES

Property	Geo-Comp 5
Minimum Average Thickness (ASTM D5994)	5 mm
Relative Density (ASTM D792)	0.94
Tensile Strength at Yield (ASTM D638)	79 N/cm
Puncture Resistance (FTMS 101)	489 N
Carbon Black Content (ASTM D1603)	2.0 %

- b. The geocomposite material supplied under the specifications shall not have defects or any signs of contamination or inclusions of foreign matter. Excessive defects may be grounds for rejecting the entire roll of geocomposite.

4.0□ Installation - Enviro Liner® 4040 Design (with Geocomposite)

- .1 The liner system consists of the following layers (starting from the top layer):
 - Geo-Comp 5 or equivalent geocomposite
 - Enviroliner 4040 or equivalent geomembrane
- .2 The liner should line the entire surface of the Facility, which includes the crest of the berms, inside slopes, and floor. The geocomposite material is only required on the floor and approach berm of the Facility.
- .3 The Contractor shall ensure that the integrity of the liner system and its components are not compromised during construction. Precautions the Contractor may take to avoid damaging the liner system may include, but will not be limited to, providing light plants in the work area to improve visibility or using pylons to mark the lift/liner system interface.
- .4 Any damage to the liner system and/or its components shall be repaired as soon as possible. Fill placement shall cease immediately in an area where the integrity of the liner system has been compromised. Fill surrounding the damaged liner system may have to be excavated, without further damaging the integrity of the liner, to permit repairs to be made. Hand excavation shall be used to expose damaged portions of the liner for repair.
- .5 The liner system shall be anchored at the top of the berm so that movement downslope does not occur during backfilling at any stage of construction.
- .6 The Contractor shall take the necessary steps to ensure that backfilling does not induce tensile stress in the liner system. Care shall be taken to avoid making sharp turns, sudden stops or sudden starts adjacent to the liner system. Non-essential heavy equipment traffic in the immediate vicinity of the liner system shall not be permitted.

Enviro Liner® Installation

- .7 The Enviro Liner® should be deployed subsequent to the placement of Zone A bedding material.

- .8 The Engineer should walk the liner to observe for any defects caused by on-site equipment and tools. Any liner area showing injury due to excessive scuffing, puncture, or distress from any cause should be replaced or repaired with an additional piece of Enviro Liner® installed as per the manufacturer's specifications over the defective area. All patches should have rounded edges and extend a minimum of 150 mm beyond the affected area.
- .9 Low ground pressure equipment should be used to deploy the liner material. No equipment shall be allowed on the liner.

Geocomposite Reinforcing Installation

- .10 The geocomposite material should be deployed subsequent to the placement of the Liner.
- .11 No equipment is permitted on the liner material during the placing of the geocomposite reinforcing material. The geocomposite reinforcing material must be rolled out by hand and the cover material placed in accordance with Section 1004.

Material Quantities

- .12 Estimated material quantities required for the lined pad are listed in Table 1005.6

TABLE 1005.6: MATERIAL QUANTITY ESTIMATES

Material	Total Area (m ²)
Enviro Liner® 4040	1900
Geo-Comp 5	905

5.0 □ Installation - HDPE 60 Design

- .1 The liner system consists of the following layers (starting from the top layer):
 - HDPE 60 mil or equivalent geomembrane
- .2 The liner should line the entire surface of the Facility, which includes the crest of the berms, inside slopes, and floor.
- .3 The Contractor shall ensure that the integrity of the liner system and its components are not compromised during construction. Precautions the Contractor may take to

avoid damaging the liner system may include, but will not be limited to, providing light plants in the work area to improve visibility or using pylons to mark the lift/liner system interface.

- .4 Any damage to the liner system and/or its components shall be repaired as soon as possible. Fill placement shall cease immediately in an area where the integrity of the liner system has been compromised. Fill surrounding the damaged liner system may have to be excavated, without further damaging the integrity of the liner, to permit repairs to be made. Hand excavation shall be used to expose damaged portions of the liner for repair.
- .5 The liner system shall be anchored at the top of the berm so that movement downslope does not occur during backfilling at any stage of construction.
- .6 The Contractor shall take the necessary steps to ensure that backfilling does not induce tensile stress in the liner system. Care shall be taken to avoid making sharp turns, sudden stops or sudden starts adjacent to the liner system. Non-essential heavy equipment traffic in the immediate vicinity of the liner system shall not be permitted.

HDPE Liner Installation

- .7 The HDPE liner should be deployed subsequent to the placement of Zone A bedding material. The liner should be placed with no horizontal seams on the slopes. Tie-in seams should be located on the floor at a minimum of 1.5 m from the toe of the slopes.
- .8 The liner panels shall be welded together along the full length of the seam to the top of the berm.
- .9 Both the wedge and the extrusion welding equipment should be qualified by conducting trial seam tests prior to start-up each day and at approximately 4-hour intervals during seaming operations. During the trial seam, the minimum peel and shear strength criteria set by the manufacturer for the 60 mil HDPE geomembrane should be met. The industry-accepted peel and shear strengths for 60 mil HDPE geomembrane are 78 ppi (pounds/inch) and 120 ppi, respectively.
- .10 The Engineer should walk the liner to observe for any defects caused by on-site equipment and tools. Any liner area showing injury due to excessive scuffing, puncture, or distress from any cause should be replaced or repaired with an additional

piece of HDPE liner extrusion welded over the defective area. All patches should have rounded edges and extend a minimum of 150 mm beyond the affected area.

- .11 Low ground pressure equipment should be used to deploy the liner material. No track-wheel equipment shall be allowed on the liner. Equipment travel on the liner material should be kept to a minimum.

Material Quantities

- .12 Estimated material quantities required for the lined pad are listed in Table 1005.7

TABLE 1005.7: MATERIAL QUANTITY ESTIMATES

Material	Total Area (m ²)
HDPE 60 Liner	1900

6.0 Installation - PVC 40 Design

- .1 The liner system consists of the following layers (starting from the top layer):
 - Geo-Comp 5 or equivalent geocomposite
 - PVC 40 mil or equivalent geomembrane
- .2 The liner system should line the entire surface of the Facility, which includes the crest of the berms, inside slopes, and floor. The geocomposite material is only required on the floor and approach berm of the Facility.
- .3 The Contractor shall ensure that the integrity of the liner system and its components are not compromised during construction. Precautions the Contractor may take to avoid damaging the liner system may include, but will not be limited to, providing light plants in the work area to improve visibility or using pylons to mark the lift/liner system interface.
- .4 Any damage to the liner system and/or its components shall be repaired as soon as possible. Fill placement shall cease immediately in an area where the integrity of the liner system has been compromised. Fill surrounding the damaged liner system may have to be excavated, without further damaging the integrity of the liner, to permit repairs to be made. Hand excavation shall be used to expose damaged portions of the liner for repair.

- .5 The liner system shall be anchored at the top of the berm so that movement downslope does not occur during backfilling at any stage of construction.
- .6 The Contractor shall take the necessary steps to ensure that backfilling does not induce tensile stress in the liner system. Care shall be taken to avoid making sharp turns, sudden stops or sudden starts adjacent to the liner system. Non-essential heavy equipment traffic in the immediate vicinity of the liner system shall not be permitted.

PVC Liner Installation

- .7 The PVC liner should be deployed subsequent to the placement of Zone A bedding material.
- .8 The Engineer should walk the liner to observe for any defects caused by on-site equipment and tools. Any liner area showing injury due to excessive scuffing, puncture, or distress from any cause should be replaced or repaired with an additional piece of PVC liner installed as per the manufacturer's specifications over the defective area. All patches should have rounded edges and extend a minimum of 150 mm beyond the affected area.
- .9 Low ground pressure equipment should be used to deploy the liner material. No equipment shall be allowed on the liner.

Geocomposite Reinforcing Installation

- .10 The geocomposite material should be deployed subsequent to the placement of the Liner.
- .11 No equipment is permitted on the liner material during the placing of the geocomposite reinforcing material. The geocomposite reinforcing material must be rolled out by hand and the cover material placed in accordance with Section 1004.

Material Quantities

.12 Estimated material quantities required for the lined pad are listed in Table 1005.8

TABLE 1005.8: MATERIAL QUANTITY ESTIMATES

Material	Total Area (m ²)
PVC 40 Liner	1900
Geo-Comp 5	905

END OF SECTION



Section 1006

QUALITY ASSURANCE

QUALITY ASSURANCE

1.0□ General

- .1 The quality assurance testing suggested is described in this section.

2.0□ Reference Standards

- .1 The most recent edition of the following American Society for Testing Materials standards:
 - a. ASTM C136 – Standard Test Method for Sieve Analysis of Fine and Coarse Aggregates.
 - b. ASTM D698 – Standard -Standard Test Methods for Laboratory Compaction Characteristics of Soil Using Standard Effort (12,400 ft-lbf/ft³ (600 kN-m/m³))
 - d. ASTM D4437 – Standard Practice for Determining the Integrity of Field Seams Used in Joining Flexible Polymeric Sheet Geomembranes.
- .2 Geosynthetic Research Institute
 - a. GRI Test Method GM6 – Pressurized Air Channel Test for Dual Seamed Geomembranes.

3.0□ Fill Particle Size Testing Requirements

- .1 Zone A Material
 - a. Samples of the Zone A material should be evaluated from locations within the borrow source prior to construction. One sample will be evaluated every 500 m³ placed during construction to ensure the placed gradation meets the specification stated herein. The required tests and testing frequency for the Zone A material are presented in Table 1006.1.

TABLE 1006.1: TESTING AND FREQUENCY OF ZONE A MATERIAL

Test	Test Frequency
Particle Size Analysis	One (1) test every 500 m ³ during construction.

.2 Zone B Material

- a. Samples of the Zone B material will be evaluated from the foundation material within the Facility prior to construction and every 2000 m³ placed during construction to ensure the placed gradation meets the specification stated herein. The required tests and testing frequency for the Zone B material are presented in Table 1006.2.

TABLE 1006.2: TESTING AND FREQUENCY OF ZONE B MATERIAL

Test	Test Frequency
Particle Size Analysis	One (1) location within the Facility and One (1) test every 2000 m ³ during construction.

4.0 □ Fill Compaction Testing Requirements

.1 Zone A Material

- a. Compact each lift with a minimum of six passes using a large smooth-drum, vibratory compactor. The optimum vibratory frequency and number of passes should be determined during construction using proof-roll tests, which demonstrate optimum compaction. The Engineer should inspect the compaction effort to ensure that this effort results in a density equivalent to about 95% MDD.

.2 Zone B Material

- a. Compact each lift with a minimum of six passes using a large smooth-drum, vibratory compactor. The optimum vibratory frequency and number of passes should be determined during construction using proof-roll tests, which demonstrate optimum compaction. The Engineer should inspect the compaction effort to ensure that this effort results in a density equivalent to about 98% MDD.
- b. The foundation material (Zone B or subcut material) should also be compacted as specified in section 1006.4.1.

5.0□ Geomembrane Testing Requirements

.1 General

- a. The Contractor is responsible for obtaining mill certificates from the manufacturer and forwarding them to the Engineer.
- b. If applicable, the Contractor shall record all seam parameters (i.e. time, date, operator, welding speed and temperature) on the liner.
- c. If applicable, the Contractor shall be responsible for completing the vacuum box testing and pressure testing for the appropriate seams. The Contractor shall mark the test number and parameters on the liner.
- d. If applicable, the Contractor shall supply and use a field tensiometer for testing liner seams for shear and peel strength.
- e. The Contractor is responsible for maintaining testing records.
- f. All coupons and test specimens remain the property of the Owner.

.2 Qualifying Welds

- a. Qualifying seams shall be conducted on fragmented pieces of material at the following times:
 - At the start of each shift of production seaming, and at 4 hour intervals during production seaming;
 - When a new operator or new machine starts welding;
 - When a machine is restarted after repairs;
 - When welding is stopped for sixty (60) minutes or more;
 - When there is a change in the ambient conditions; and
 - At the discretion of the Engineer.
- b. Qualifying seams shall be 1 m long, and shall be subject to shear and peel testing. The test seam shall meet the minimum requirements stated herein for seam strength, when tested on a field tensiometer. If a qualifying seam fails, the seaming procedure shall be reviewed and the test shall be repeated.

.3 Non-Destructive Testing

- a. Test all wedge-welded seams over their full length using a vacuum unit or air pressure test.
 - Seam intersections will also be subject to vacuum box testing, regardless of seaming method employed.
 - The Contractor shall supply all apparatus and personnel for this type of test.
 - The tests shall be witnessed and documented by the Engineer.
- b. Clean all seams to permit proper inspection.
- c. Repair any seams which fail non-destructive testing in accordance with this Specification. Repairs shall be fully documented by the Contractor.

.4 Vacuum Box Testing

- a. Extrusion welded seams should be tested using either vacuum box testing or pick-testing. Vacuum box testing involves placing the extrusion weld under a vacuum. The weld is first coated with a soapy water solution and any holes in a weld would be indicated by a stream of bubbles when vacuum is applied.
- b. No leaks shall be permitted while conducting vacuum box testing.
- c. Pick-testing is conducted on uneven surfaces where a vacuum cannot be maintained. During pick testing, attention should be paid to the following specific items:
 - The width of the weld;
 - Weld bond to the underlying geomembrane;
 - Joints between three panels (“T” joints);
 - Defects such as bubbles created within the weld due to moisture; and
 - Textured weld surfaces due to temperature fluctuation in the extrusion welder.

.5 Air Pressure Testing

- a. Wedge welded seams should be air-pressure tested over their full lengths using an air pressure test. Air pressure testing involves pressurizing the air channel located between the dual tracks of the seams to a minimum pressure of 40 psi for a period of five minutes.
- b. During the test, the air pressure is not allowed to drop more than 4 psi (10% allowance). Any leaks and bubbling in the seams found during the non-destructive tests must be repaired by extruding a patch of HDPE material over the defect.
- c. Air pressure testing shall be carried out according to GRI Test Method GM6, Pressurized Air Channel Test for Dual Seamed Geomembranes.

.6 Destructive Testing for Production Seams

- a. Cut-out coupons shall be taken at a minimum frequency of one (1) per 150 m of seam, or once per seam. Coupons shall be cut by the contractor at the location directed by the Engineer. Coupons shall generally be taken from a location that does not affect the performance of the liner. All cut-outs shall have rounded corners. Care shall be taken to ensure that no slits penetrate the parent liner.
- b. All holes left by cut outs shall be patched immediately.

.7 Testing of Repairs

- a. All repairs shall be tested using the Vacuum Box in accordance with test method ASTM 4437.

END OF SECTION



Section 1007

DESIGN ALTERNATIVES

DESIGN ALTERNATIVES

1.0 □ General

- .1 This section provides design alternatives for the Facility should the fill materials available on or near site not adhere to the gradation specifications stated in Tables 1003.1 and 1003.2.
- .2 Should Zone A, Zone B or both materials not meet the gradation specifications stated in Tables 1003.1 and 1003.2 then the recommended design alternatives are available in Table 1007.1.

TABLE 1007.1: RECOMMENDED DESIGN ALTERNATIVES FOR GRADATION NON-COMPLIANCE				
		Zone B		
		Meets Specifications	Gradation Below Fine Limit	Gradation Above Coarse Limit
Zone A	Meets Specifications	This section does not apply	This section does not apply	See Section 1007.2
	Gradation Below Fine Limit	See Section 1007.2	See Section 1007.2	See Section 1007.2
	Gradation Above Coarse Limit	See Section 1007.3	See Section 1007.3	See Section 1007.4

2.0 □ Detailed Design Alternatives – Non-Compliance Criteria I

- .1 If the fill materials do not comply with gradation specifications as per Table 1007.1 geotextile material is required at the interface between Zone A and Zone B materials.
- .2 The geotextile material should be deployed prior to the placement of Zone A material.
- .3 The geotextile should be placed with a minimum overlap of 150 mm and connected at the seam by heat bonding. If heat bonding is not available an overlap of 300 mm should be used. Horizontal seams should be kept to a minimum on the side slopes. If a horizontal seam is unavoidable, the overlap shall be capped with a 300 mm wide strip of the same geotextile and heat bonded to the underlying material.
- .4 Any tears or holes made in the geotextile should be repaired by placing a patch of geotextile on the defect and held in place by heat bonding. The patch should extend at least 300 mm beyond the damage, in all directions.

3.0□ Detailed Design Alternatives – Non-Compliance Criteria II

- .1 If the fill materials do not comply with gradation specifications as per Table 1007.1 geotextile material is required above and below the liner system.
- .2 The geotextile material should be deployed prior to the deployment of the liner system as well as subsequent to the deployment of the liner system.
- .3 The geotextile should be placed with a minimum overlap of 150 mm and connected at the seam by heat bonding. If heat bonding is not available an overlap of 300 mm should be used. Horizontal seams should be kept to a minimum on the side slopes. If a horizontal seam is unavoidable, the overlap shall be capped with a 300 mm wide strip of the same geotextile and heat bonded to the underlying material.
- .4 Any tears or holes made in the geotextile should be repaired by placing a patch of geotextile on the defect and held in place by heat bonding. The patch should extend at least 300 mm beyond the damage, in all directions.

4.0□ Detailed Design Alternatives – Non-Compliance Criteria III

- .1 If the fill materials do not comply with gradation specifications as per Table 1007.1 geotextile material is required above and below the liner system as well as at the interface between Zone A and Zone B materials.
- .2 The geotextile material should be placed prior to the placing of Zone A material, prior to the deployment of the liner system as well as subsequent to the deployment of the liner system.
- .3 The geotextile should be placed with a minimum overlap of 150 mm and connected at the seam by heat bonding. If heat bonding is not available an overlap of 300 mm should be used. Horizontal seams should be kept to a minimum on the side slopes. If a horizontal seam is unavoidable, the overlap shall be capped with a 300 mm wide strip of the same geotextile and heat bonded to the underlying material.
- .4 Any tears or holes made in the geotextile should be repaired by placing a patch of geotextile on the defect and held in place by heat bonding. The patch should extend at least 300 mm beyond the damage, in all directions.

END OF SECTION



Section 1008

OPERATION AND MAINTENANCE

OPERATION AND MAINTENANCE

5.0□ General

- .1 This section provides a general guideline for the operation and maintenance of the Waste Containment Facility.

6.0□ Geomembrane Lined Pad

- .1 Structure Maintenance
 - a. This section refers to the structure as the berm, side slopes, and floor of the Facility.
 - b. The structure shall be inspected regularly. Attention shall be concentrated on the following:
 - Eroded and/or damaged granular slope and floor surfaces and
 - Exposed liner material
 - c. Any identified problems should be repaired immediately. The repair can be conducted by reconstructing the damaged or eroded slopes with a material of similar gradation to Zone A material. Any exposed liner material can be recovered with Zone A material; however, if the liner material is damaged, liner installation personnel shall be retained to repair the liner.
- .2 Surface Water Management
 - a. The Facility is designed to drain all surface water to the installed vertical culvert. Each month, the water level must be inspected, pumped and disposed of appropriately.
 - b. The frequency of monitoring must be increased during times of high precipitation or snow melt within the Facility.

7.0□ Filling Procedure

- .1 The filling procedure for the Facility is as follows:
 - a. Waste material is not to exceed a height of 3.0 m above the level of the top of the berm unless approved by the Engineer;
 - b. Waste material is not to be placed higher than relative elevation 0.5 m below the crest of the liner unless approved by the Engineer.

8.0 Closure

- .1 Upon reaching capacity the Facility will be capped with material meeting the specifications outlined in Table 1008.1 or as approved by the Engineer.

TABLE 1008.1: CAPPING MATERIAL- PARTICLE SIZE DISTRIBUTION LIMITS

Sieve Size (mm)	% Passing Fine Limit	% Passing Coarse Limit
100	100	100
50	95	100
25	90	100
20	85	100
5	65	90
0.63	35	60
0.08	5	20

- .2 The capping material shall have a minimum thickness of 0.5 m.
- .3 The vegetative cover must be capable of self-regeneration without continuous dependence on fertilizer or re-seeding.
- .4 The vegetative cover must have sufficient density and species diversity to stabilize the surface against the effects of long term erosion.
- .5 Closure monitoring should include inspection for any ponding water. If ponded water is present capping material should be added or re-graded.

END OF SECTION



APPENDIX

APPENDIX A CONSTRUCTION DRAWINGS

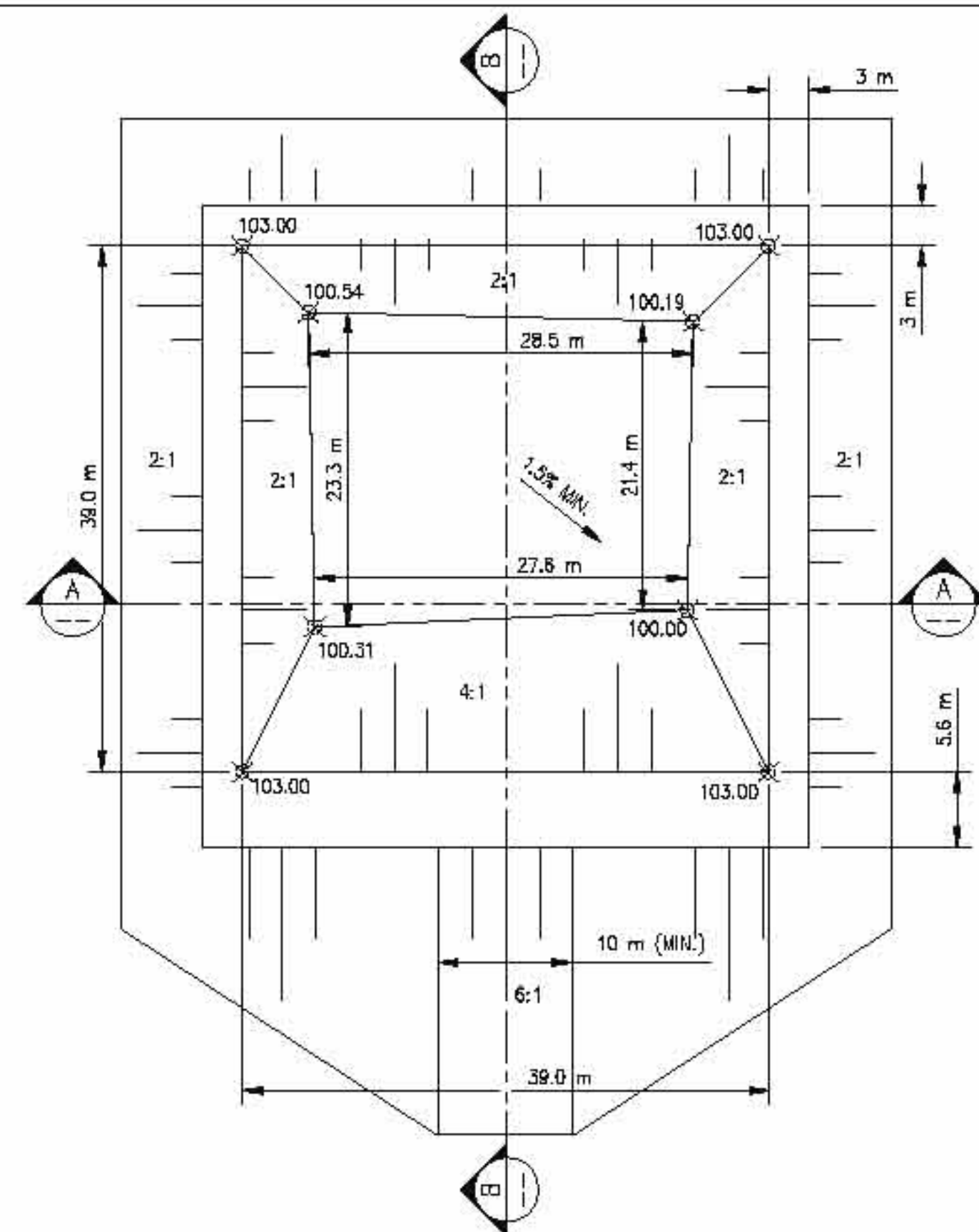

PLAN - ZONE B MATERIAL
SCALE 1 : 400

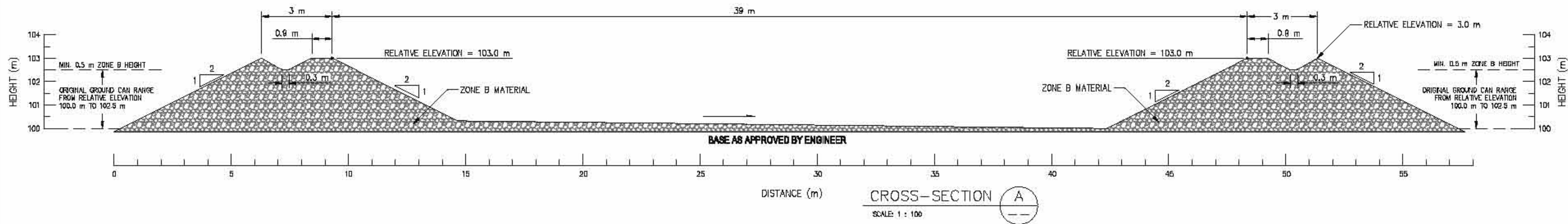

CROSS-SECTION A
SCALE 1 : 100

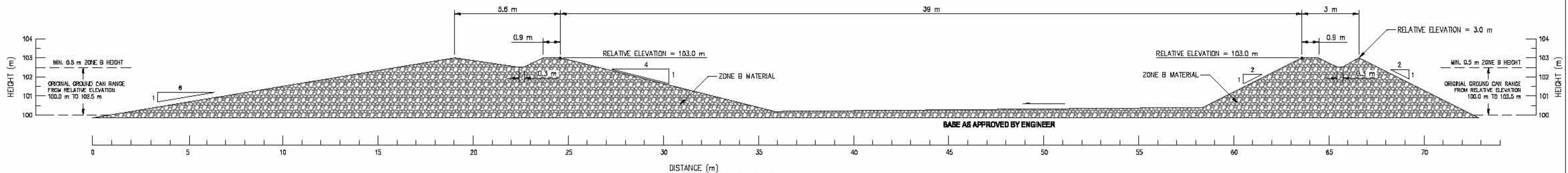

CROSS-SECTION B
SCALE 1 : 100

ISSUED FOR CONSTRUCTION

NOTES

1. CONTAINMENT FACILITY SIZED FOR 1000 m³ OF GEOMEMBRANE. CONFIGURATION OF BASE AREA CAN BE MODIFIED SHOULD SITE CONDITIONS WARRANT. HOWEVER, SPECIFIED BERM CROSS-SECTION, FILL MATERIALS, LINER SYSTEM AND GENERAL DESIGN CRITERIA MUST BE ADHERED TO.
2. SPECIFIC CONDITIONS AND FACILITY LOCATION HAVE NOT BEEN PROVIDED OR CONSIDERED. ONCE FACILITY LOCATION AND SITE SPECIFIC CONDITIONS ARE KNOWN, THEY MUST BE APPROVED BY THE ENGINEER PRIOR TO CONSTRUCTION.
3. ALL ELEVATIONS ON PLAN ARE FOR TOP OF ZONE B MATERIAL.

NUM	DATE	DWN	CKD	APR	DESCRIPTION
B	06/07/08	JPS			ISSUED FOR CONSTRUCTION
A	06/09/08	JPS			ISSUED FOR REVIEW
		APR			DESCRIPTION

ORIGINAL
SIGNED AND SEALED

Permit: J. Richard Trinkle, P.Eng. Date: July 8, 2008
Seal: Jason Barkers, P.Eng. Date: July 9, 2008

The signed Professional Seal and Permit to Practice
source reside on the associated drawing which is held
and controlled by EBA Engineering Consultants Ltd.

PERMIT

PROFESSIONAL SEAL

CLIENT



EBA Engineering
Consultants Ltd. eba

TYPICAL WASTE CONTAINMENT FACILITY DESIGN
KENO HILL, SILVER DISTRICT, YT

ZONE B MATERIAL PLAN & CROSS SECTIONS

PROJECT NO.	OFFICE	DES.	CHK.	REV.	DRAWING
W14101142	WHSE	JTP	JPS	0	WCF-1
DATE:	SHEET NO.	DWN.	APP.	BY/DATE	
June 26, 2008	1 of 4	KJT	JRT	B	

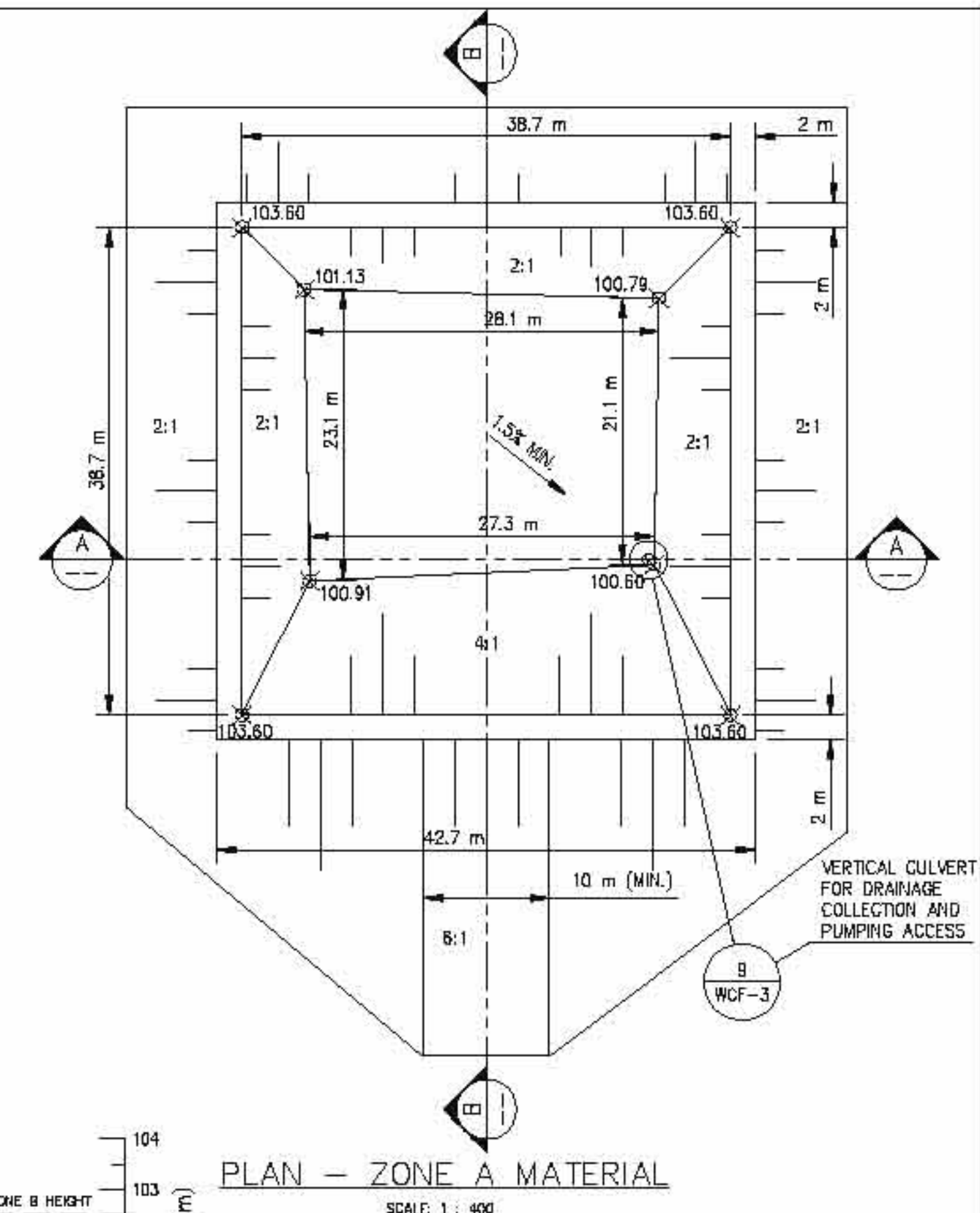

PLAN - ZONE A MATERIAL
SCALE: 1 : 400

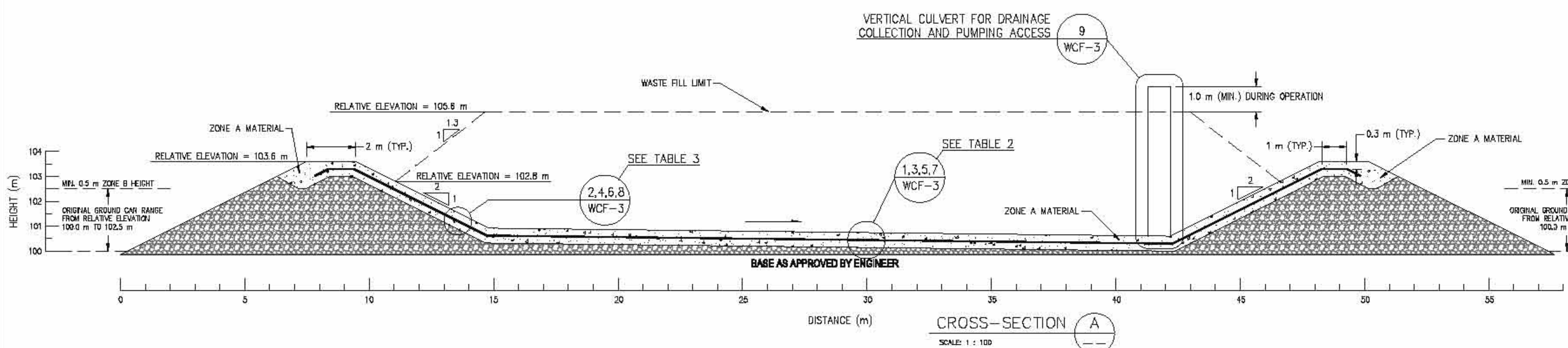

CROSS-SECTION A
SCALE: 1 : 100

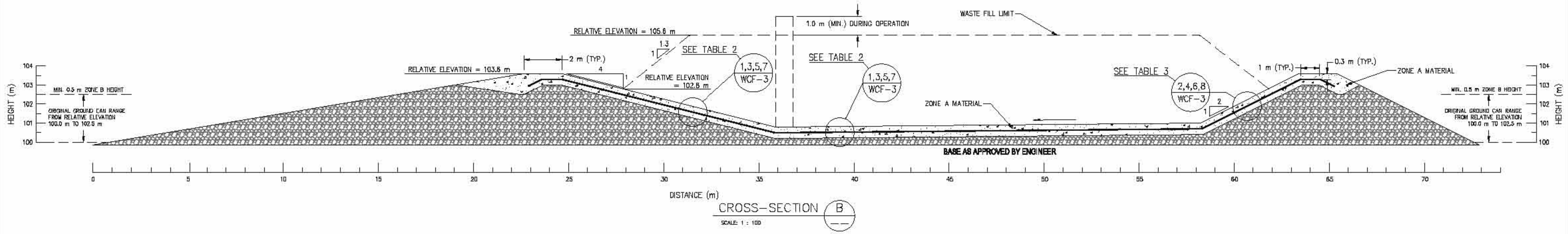

CROSS-SECTION B
SCALE: 1 : 100

ISSUED FOR CONSTRUCTION

- NOTES**
1. CONTAINMENT FACILITY SIZED FOR 1000 m² OF GEOMEMBRANE. CONFIGURATION OF BASE AREA CAN BE MODIFIED SHOULD SITE CONDITIONS WARRANT. HOWEVER, SPECIFIED BERM CROSS-SECTION, FILL MATERIALS, LINER SYSTEMS AND GENERAL DESIGN CRITERIA MUST BE ADHERED TO.
 2. SPECIFIC CONDITIONS AND FACILITY LOCATION HAVE NOT BEEN PROVIDED OR CONSIDERED. ONCE FACILITY LOCATION AND SITE SPECIFIC CONDITIONS ARE KNOWN, THEY MUST BE APPROVED BY THE ENGINEER PRIOR TO CONSTRUCTION.
 3. ALL ELEVATIONS ON PLAN ARE FOR TOP OF ZONE A MATERIAL.

NUM	DATE	DWN	CKD	APR	DESCRIPTION
B	08/07/08	JPS			ISSUED FOR CONSTRUCTION
A	08/02/08	JPS			ISSUED FOR REVIEW
		APR			DESCRIPTION

ORIGINAL SIGNED AND SEALED

Permit: J. Richard Trinkle, P.Eng. Date: July 8, 2008
 Seal: Jason Barkers, P.Eng. Date: July 8, 2008

The signed Professional Seal and Permit to Practice (where applicable) are on the associated drawing which is held and controlled by EBA Engineering Consultants Ltd.

ALEXCO

EBA Engineering Consultants Ltd.

TYPICAL WASTE CONTAINMENT FACILITY DESIGN
KENO HILL SILVER DISTRICT, YT

ZONE A MATERIAL PLAN & CROSS SECTIONS

PROJECT NO: W14101142
 OFFICE: WHSE
 DATE: June 26, 2008

DWG: JTP
 APP: KJT

REV: 0
 DATE: 08/07/08

DRAWN BY: JPS
 CHECKED BY: JRT

WCF-2

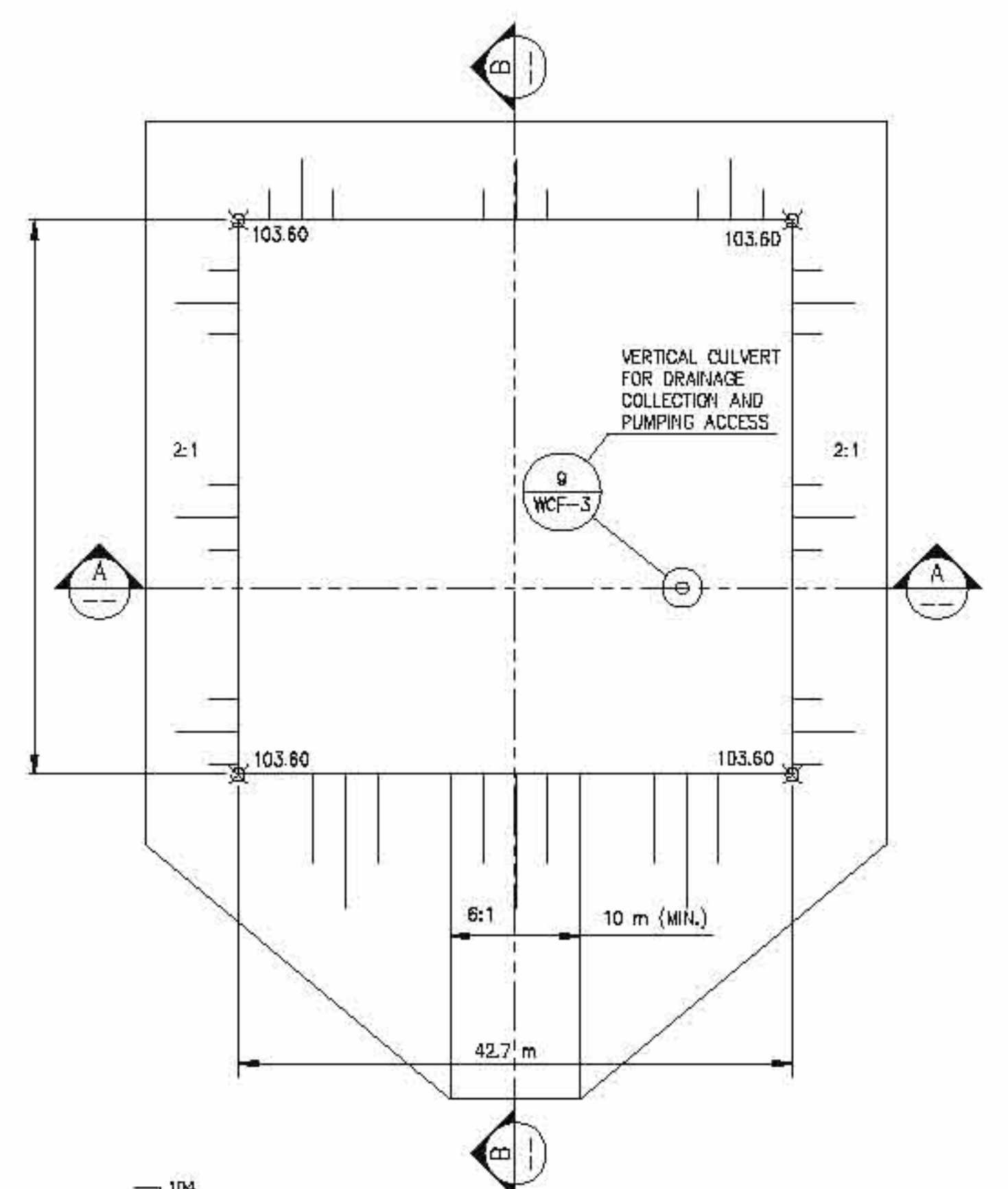
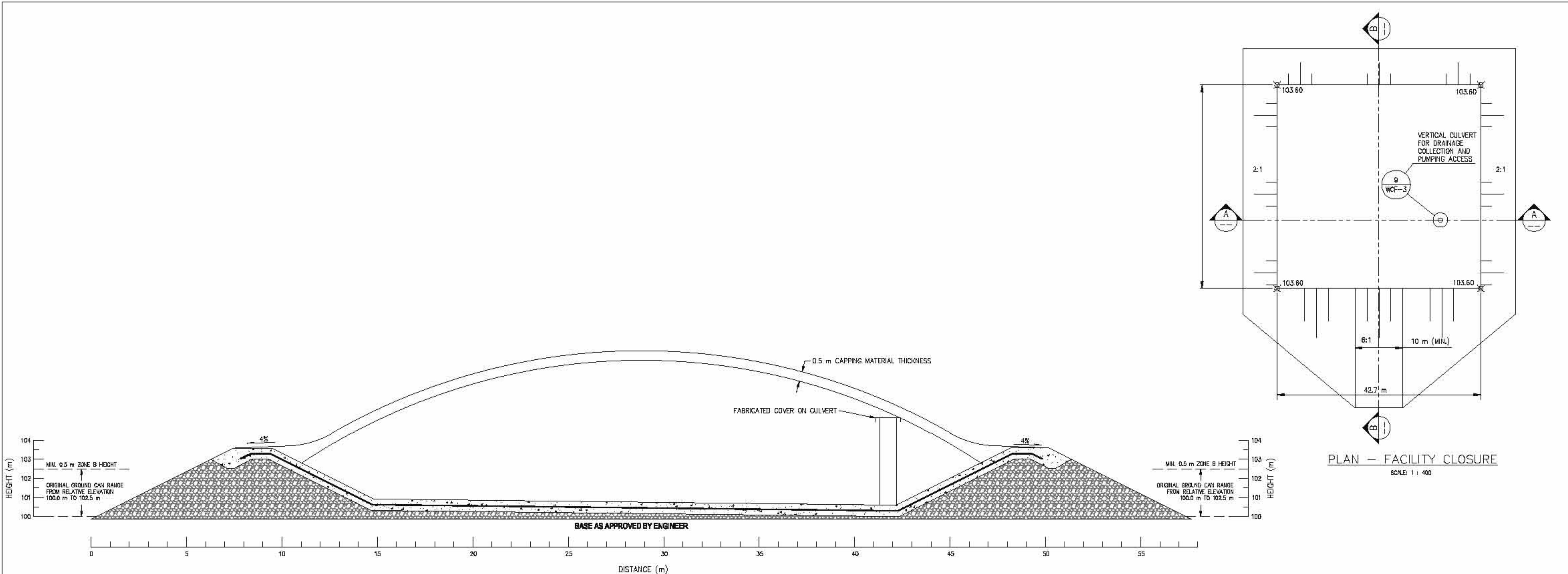

CROSS-SECTION A
SCALE: 1: 100

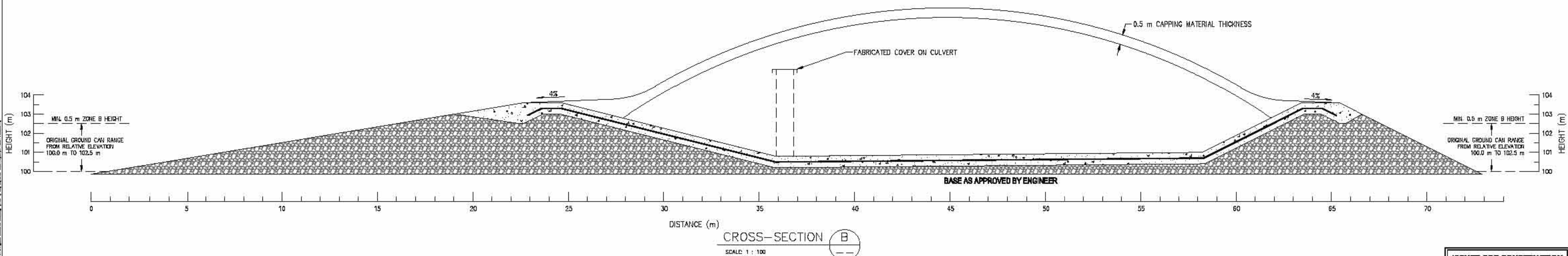

CROSS-SECTION B
SCALE: 1: 100

ISSUED FOR CONSTRUCTION

- NOTES**
1. CONTAINMENT FACILITY SIZED FOR 1000 m² OF GEOMEMBRANE. CONFIGURATION OF BASE AREA CAN BE MODIFIED SHOULD SITE CONDITIONS WARRANT. HOWEVER, SPECIFIED BERM CROSS-SECTION, FILL MATERIALS, LINER SYSTEMS AND GENERAL DESIGN CRITERIA MUST BE ADHERED TO.
 2. SPECIFIC CONDITIONS AND FACILITY LOCATION HAVE NOT BEEN PROVIDED OR CONSIDERED. ONCE FACILITY LOCATION AND SITE SPECIFIC CONDITIONS ARE KNOWN, THEY MUST BE APPROVED BY THE ENGINEER PRIOR TO CONSTRUCTION.

NUM	DATE	DWN	CKD	APR	DESCRIPTION
2	08/07/08	JPS			ISSUED FOR CONSTRUCTION
1	08/06/08	JPS			ISSUED FOR REVIEW
		APR			DESCRIPTION

ORIGINAL SIGNED AND SEALED

Permit: J. Richard Trinkle, P.Eng. Date: July 8, 2008
 Seal: Jason Barkers, P.Eng. Date: July 8, 2008

The signed Professional Seal and Permit to Practice (where applicable) are on the associated drawing which is held and controlled by EBA Engineering Consultants Ltd.

ALEXCO

EBA Engineering Consultants Ltd.

TYPICAL WASTE CONTAINMENT FACILITY DESIGN
KENO HILL SILVER DISTRICT, YT

FACILITY CLOSURE PLAN & CROSS SECTIONS

PROJECT NO.	OFFICE	DESIGN	CHKD	ISSUED	DRAWING
W14101142	WHSE	JTP	JPS	0	
DATE	SHEET NO.	DWN	APP	BY/DATE	
June 26, 2008	4 of 4	KJT	JRT	B	

WCF-4