

Teck

Sä Dena Hes 2020 Annual Mine Waste Facilities Inspection

Prepared for

Teck Resources Limited



Prepared by

 **srk** consulting

SRK Consulting (Canada) Inc.
1CT008.073
October 2020

Sä Dena Hes 2020 Annual Mine Waste Facilities Inspection

October 2020

Prepared for

Teck Resources Limited
601 Knighton Road
Kimberley, BC Y1A 3E1
Canada

Tel: +1 250 427 8413
Web: www.teck.com

Prepared by

SRK Consulting (Canada) Inc.
2200–1066 West Hastings Street
Vancouver, BC V6E 3X2
Canada

Tel: +1 604 681 4196
Web: www.srk.com

Project No: 1CT008.073

File Name: SDH 2020 TSF Annual Report_1CT008-073_20201023-FNL.docx

Copyright © SRK Consulting (Canada) Inc., 2020



Executive Summary

This report presents the results of the 2020 Annual Mine Waste Facilities Inspection (MWF) of the structures and features associated with the Tailings Management Area (TMA) that forms part of the closed Sä Dena Hes mine located near Watson Lake, Yukon. The only remaining tailings retaining embankment at the closed site is the North Dam. A small dike referred to as the Sediment Retaining Structure (SRS) was also retained after closure of the site to collect any sediment that would be generated from the till cap that was placed over the exposed tailings. Other structures included in the MWF scope are a series of newly constructed (2014) ripped lined diversion channels and the reclaimed waste rock dumps at the location of the closed portals adjacent to the Main, Jewelbox and Burnick ore zones.

The inspection was completed by Mr. Peter Healey, PEng., an associate of SRK Consulting (Canada) Inc., on July 28, 2020 while accompanied by Morgan Lypka (Teck), Peter Mikes (SRK) and Jeff Basarich (Teck). Mr. Healey is the Engineer of Record (EoR) for the site and has been completing the annual dam inspections since 1992.

The work was completed in accordance with Teck's Tailings and Water Retaining Structures (TWRS) guideline and policy (2019), the Yukon Territory Sä Dena Hes Water Licence issued April 2017 (QZ16-051) and the Quartz Mining License QML-0004.

Summary of Facility Description

The original TMA consisted of three earth structures, which were referred to as the North Dam, the South Dam and the Reclaim Dam. The North and South Dams, which impounded the tailings, were constructed between July 1990 and October 1991. The starter dams for both structures were built to a height of about 13 metres.

In addition to the North and South Dams, a reclaim dam was built to detain supernatant water decanted from the tailings pond. The mine operation involved recycling of the detained water to the mill, with a controlled discharge when required into the adjacent Camp Creek from April to October each year.

Operations at Sä Dena Hes mine by Curragh Resources, which commenced in July 1991, were suspended in December 1992 due to low lead and zinc prices. Decommissioning of the site began in 2014 and was completed in 2015 by the Sä Dena Hes Operating Corp.

Tailings and water retaining structures that currently remain on the site are the North Dam and the Sediment Retaining Structure (SRS). The SRS is a 7 m high dike which impounds a small pond.

Summary of Key Hazards and Consequences

As a required component of a MWF, the following hazards at the site were identified and the consequences of different failure modes of the North Dam and the SRS were assessed:

- runoff from extreme precipitation events,
- seismic events,
- ice build up and debris in the SRS spillway,
- flow capacity of the SRS spillway, and
- potential for liquefaction of the tailings.

The key failure modes for the North Dam are:

- Internal Erosion (Piping), and
- Slope Stability.

The assessment concluded that the North Dam and the SRS Dike are in good condition, meet current expectations and fall within acceptable guidelines for stability. SRK understands that Teck's long-term goal for all tailings facilities is to reach landform status with all potential failure modes being reduced to non-credible. There exists no credible catastrophic failure modes for the North Dam and SRS Dike. The likelihood of the above failure modes is very rare based on extreme consequence loading conditions and conservative assumptions. Whether the failure modes are credible or non credible will be evaluated in a future study that will verify or refine the conservative assumptions.

Consequence Classifications

Consequence classification is not related to the likelihood of a failure, but rather the potential impact resulting from a failure if it did occur. The last Dam Safety Review (DSR) was carried out by AMEC Foster Wheeler (AMECFW) (now the Wood Group) in 2015. Based on this review, the CDA Dam Consequence Classification (CC) of the North Dam was changed from "Low" to "Significant" and the CC for the SRS remained as "Low". The change for the North Dam was based on an issue raised by AMECFW noting that there was a potential for liquefaction of the tailings if the dam were to fail and that during a flood event there was a potential for overtopping of the dam. The Consequence Classification of the Sediment Retaining Structure was assessed during the MWF1 and remains "Low".

The next DSR is scheduled for 2025.

Summary of Key Observations

North Dam

The North Dam is in good condition and shows no signs of deformation or abnormal settling. The downstream slope of the dam shows no signs of surficial movement or erosion nor is there any sign of bulging at the downstream toe.

The piezometers are in good condition and continue to function as designed. The seasonal fluctuations recorded in latter part of 2019 and 2020 in the piezometers are consistent with those

in previous years except for readings taken in late May and late August 2020. On both occasions water levels in Piezometer 2A triggered an alert indicating an exceedance just above the acceptable trigger level. Following a review of the data and the local precipitation records for the same period, it is SRK's opinion that these unexpected rises in the water levels in Piezometer 2A were attributed to an unseasonably high snowpack and rainfall. Subsequent readings are more consistent with trends seen in previous years. No further action is required outside of continued monitoring.

The readings taken of the settlement gauges in the North Dam indicate that there has been no unexpected settlement of the embankment over the 27-year period that readings have been taken, with settlement readings varying to a maximum of 51 mm (or less than 1% of the total height of the dam) from the initial readings taken in 1993. In the last five years, settlement readings have fluctuated less than 1 mm.

Sediment Retaining Structure

The SRS is in good physical condition and the spillway is functioning in accordance within design parameters.

North Creek

Beaver activity was again evident at the inlet to the channel with the construction of a beaver dam. The dam raises the water level of the pond behind the structure and increases the risk of a rapid release of water that could result in erosion of the riprap protection in the channel. The beaver dam was removed in 2020. Best Practice dictates that beaver dams be removed when identified during the routine inspections. However, there are no downstream structures that are at risk if the beaver dam was to breach.

On the north side of the channel at the second crossing of the North Creek, it was noted that high flows have eroded a portion of the bank on one side of the channel. North Creek will continue to erode this section of the channel area but will eventually sustain itself without maintenance. No remedial action is required.

North Drainage Channel

Seepage from the hillside above the North Drainage channel has triggered a subsidence on the west side of the channel which could undermine the channel at that location. While this is not considered a risk to the SRS dike nor to the environment as it is contained, flow that would be redirected by a premature collapse of the channel wall could disturb some of the covered tailings and release additional sediment into the SRS pond. This subsidence should be repaired by buttressing with riprap borrowed from the downstream portion of the North Drainage Channel.

Summary of Significant Changes

There are no significant changes to the stability of either the North Dam or the SRS since their construction in 1991 and 2014, respectively.

Summary of Review of OMS and EPRP Manuals

The Operation, Maintenance and Surveillance (OMS) Manual was originally prepared by SRK in 2015. The manual is reviewed annually and was reviewed as part of this 2020 MWFI. Key changes to the OMS, of which the update is in draft, include:

1. A table for document control regarding Records Retention Time for tailings and water facilities.
2. A RASCI table for tailings management
3. Updated organization chart.
4. Roles and responsibility table
5. Required Proficiency and Training table.
6. Document Change Management section.
7. Trigger Action Response Plan (TARP) to added Appendices

The current Emergency Preparedness and Response Plan (EPRP) was prepared by SRK in 2015. Teck is currently developing a Mine Emergency Response Plan (MERP) for the Sä Dena Hes site which would replace the EPRP – the MERP is currently in draft and applicable sections were informed by the EoR in 2020.

Summary Table of Deficiencies and Non-Conformances

A list of deficiencies or non-conformances noted from the 2020 MWFI, as well as from the 2019 inspection, are summarized in the following table:

.

Table of Recommendations from the 2019 and 2020 Mine Waste Facilities Inspections

Structure	ID No.	Deficiency or Non-Conformance	Applicable Regulation or OMS Reference	Recommended Action	Priority (Teck 2019)	Recommended Deadline /Status
North Creek Channel	2019-1	Beaver Dam at inlet to channel	Sec. 6.2 and 6.4 of OMS	Remove beaver dam in channel	3	Before end of 2019 Completed September 5, 2019 Closed
North Creek Channel	2020-01	Beaver Dam at inlet to channel	Sec. 6.2 and 6.4 of OMS	Remove beaver dam in channel	3	Before end of 2020 Completed September 2020 Closed
Seepage Monitoring at d/s toe of North Dam at MH-02	2020-2	Gauge displaced	Sec. 7.1.1 and Table 26 of OMS	Re-position pipe gauge	3	Before end of 2020 Completed September 2020 Closed
Monitoring Pins at base of Jewelbox WR Dump	2020-3	Erosion Gully	Sec. 7.1.1 and Table 26 of OMS	Re-establish Monitoring pins	3	Before end of 2020 Completed September 2020 Closed
North Drainage Channel	2020-4	Side wall subsidence	Sec. 6.2 and 6.4 of OMS	Buttress with riprap	3	Before end of 2020 Completed September 2020 Closed

General Description of Priority Rankings¹

Priority	Description
1	A high probability or actual dam safety issue considered immediately dangerous to life, health or the environment, or a significant regulatory concern.
2	If not corrected, could likely result in dam safety issues leading to injury, environmental impact or significant regulatory action; or, a repetitive deficiency that demonstrates a systematic breakdown of procedures.
3	Single occurrences of deficiencies or non-conformances that alone would not be expected to result in dam safety issues.
4	Best Management Practice as a suggestion for continuous improvement towards industry best practices that could further reduce potential risks. This typically includes ongoing construction items within the appropriate construction cycle.

¹ Based on the Health, Safety and Reclamation Code (HSRC) for Mines in British Columbia (2016 revision).

Table of Contents

1	Introduction	1
1.1	Purpose, Scope of Work, and Methodology	1
1.2	Regulatory Requirements and Guidelines	2
1.3	Facility Description	2
1.3.1	Overview	2
1.3.2	North Dam	2
1.3.3	Sediment Retaining Structure (SRS)	3
1.3.4	Water Management Infrastructure	3
1.3.5	Tailings Cover	4
1.3.6	Waste Rock Dumps	5
1.4	Summary of History	5
2	Maintenance and Surveillance during 2019 to 2020	5
3	Climate Data and Water Balance	5
3.1	Review and Summary of Climate Data	5
3.1.1	Mean Annual Precipitation	5
3.1.2	2019-2020 Analysis	6
3.1.3	Evaporation	7
3.2	Review and Summary of Water Balance	7
3.3	Freeboard and Storage	8
3.3.1	North Dam	8
3.3.2	SRS	9
3.4	Water Discharge Volumes	9
3.5	Water Discharge Quality	9
4	Site Observations	9
4.1	Visual Observations	9
4.1.1	North Dam	9
4.1.2	Till Tailings Cover	10
4.1.3	Sediment Retaining Structure	10
4.1.4	Drainage Channels	10
4.1.5	North Creek	11
4.1.6	Landfill, Burnick and Jewelbox Waste Rock Dumps	11
4.2	Photographs	12
4.3	Instrumentation Review	12
4.3.1	Water Levels	12
4.3.2	Deformation/Settlement	12

4.3.3	Stability/Lateral Movement.....	14
4.3.4	Discharge Flows.....	14
4.4	Pond and Discharge Water Quality	15
4.5	Site Inspection Forms	15
4.6	Facility Data Sheet.....	15
5	Facility Safety Assessment	15
5.1	Facility Classification Review.....	15
5.2	Design Basis Review	18
5.2.1	North Dam.....	18
5.2.2	Sediment Retaining Structure	18
5.3	Hazards and Failure Modes Review.....	19
5.3.1	Dam Overtopping	19
5.3.2	Internal Erosion	20
5.3.3	Slope Stability	20
5.4	SRS.....	22
5.4.1	Surface Erosion.....	22
5.5	Review of Downstream and Upstream Conditions	22
5.5.1	Downstream Conditions (South).....	22
5.5.2	Upstream Conditions (North)	22
5.6	Physical Performance	23
5.6.1	Geotechnical	23
5.6.2	Hydrotechnical	23
5.6.3	Hydrogeological	23
5.6.4	Geochemistry	25
5.7	OMS Manual Review	25
5.8	Emergency Preparedness and Response Review.....	26
6	Summary and Recommendations.....	26
6.1	Summary of Construction and Operation Activities	26
6.2	Summary of Climate and Water Balance	26
6.3	Summary of Performance.....	26
6.4	Summary of Changes to Facility or Upstream or Downstream Conditions	26
6.5	Table of Deficiencies and Non-Conformances	27
7	References.....	30

List of Figures

Figure 1:	Vicinity Map
Figure 2:	TMA General Arrangement Map
Figure 3:	North Dam Site Plan
Figure 4:	North Dam Section 0+400
Figure 5:	Sediment Retaining Structure Location Map
Figure 6:	Sediment Retaining Structure Plan and Profile
Figure 7:	Drainage Channel Plan
Figure 8:	Drainage Channel Sections
Figure 9:	North Drainage Channel Sections
Figure 10:	Catchment Areas
Figure 11:	Burnick Zone Plan View
Figure 12:	Main Zone and Jewelbox Zone Plan View
Figure 13:	North Dam Settlements

List of Tables

Table 3-1: Selected Meteorological Stations Associated with the Project Site (1960 to 2016)	6
Table 3-2: Monthly Average Precipitation for the Site	6
Table 3-3: 2019-20 Monthly Precipitation for the Site (based on Watson Lake Data).....	7
Table 3-4: Mean Monthly Lake Evaporation	7
Table 3-5: Summary of Site Water Balance (2019-2020).....	8
Table 4-1: Summary of Elevations Taken at the top of the North Dam Settlement Gauges	13
Table 5-1: CDA (2014) Dam Classification in Terms of Consequences of Failure.....	17
Table 5-2: Design Criteria of the North Dam (Updated)	18
Table 5-3: Design Criteria for the SRS	19
Table 5-4: Target Levels for Earthquake Hazards/Factor of Safety, 2014 CDA Guidelines	20
Table 5-5: Stability Analysis Results.....	21
Table 5-6: Estimated Peak flows for the SRS Spillway	23
Table 6-1: Table of Recommendations from the 2019 and 2020 Annual Mine Waste Facilities Inspections	28
Table 6-2: General Description of Priority Rankings.....	29

Appendices

Appendix A – Photos

Appendix B – Piezometers

Appendix C – Facility Data Sheets

Appendix D – Site Background Information and History

List of Abbreviations

AEP	Annual Exceedance Probability
AMECFW	AMEC Foster Wheeler
CC	Consequence Classification
CDA	Canadian Dam Association
CSP	Corrugated Steel Pipe
DDRP	Detailed Decommissioning Reclamation Plan
DSR	Dam Safety review
ECCC	Environment Climate Change Canada
EOIR	Engineer of Record
EPRP	Emergency Preparedness and Response Plan
FoS	Factor of Safety
HSRC	Health, Safety and Reclamation Code
IDF	Inflow Flood Design
KCB	Klohn Crippen Berger
MERP	Mine Emergency Response Plan
MWFI	Mine Waste Facility inspection
NBC SHC	National Building Code Seismic Hazard Calculator
OMS	Operation, Maintenance, Surveillance
PGA	Peak Ground Acceleration
PMF	Probable Maximum Flood
PMP	Probable Maximum Precipitation
SRS	Sediment Retaining Structure
TMA	Tailings Management Area
TWRS	Tailings and Water Retaining Structures

1 Introduction

1.1 Purpose, Scope of Work, and Methodology

This report presents the results of the 2020 Mine Waste Facilities Inspection (MWF I) of the structures and features associated with the Tailings Management Area (TMA) that forms part of the closed Sä Dena Hes mine located near Watson Lake, Yukon. The current Yukon Water Licence (QZ16-051), Quartz Mining License QML-0004, and Teck's Guideline for Tailings and Water Retaining Structures (Teck 2019). The work was authorized by Ms. Morgan Lypka, Teck Resources Limited (Teck) on behalf of the Sä Dena Hes Operating Corp.

Mr. Peter Healey, PEng, an associate of SRK Consulting (Canada) Inc., completed the site inspection on July 28, 2020 while accompanied by Morgan Lypka (Teck), Peter Mikes (SRK) and Jeff Basarich (Teck). Mr. Healey is the Engineer of Record (EoR) for the site and has been completing the annual dam inspections since 1992.

The scope of the work consisted of:

- A visual inspection of the physical condition of the following structures and features to identify any deficiencies and non-conformances:
 - The North Tailings Dam
 - The North Creek channel that was reclaimed following decommissioning of the North Creek Dike and Second Crossing of North Creek
 - The relocated Camp Creek drainage channel
 - The North and South drainage Channels
 - The Sediment Retaining Structure (SRS)
 - The Burnick, Main Zone and Jewelbox Waste Rock Dump areas
- A review of the Operation, Maintenance and Surveillance Manual (OMS) and Emergency Preparedness and Response Plan (EPRP) for the TMA
- A review of the Dam Consequence Classifications
- A review of the routine site inspection forms provided by Teck
- A review of the piezometer and settlement records of the North Dam provided by Teck
- A review of the 2015 Dam Safety Review (DSR) carried out by AMEC Foster Wheeler (AMECFW), now the Wood Group

It should be noted that all elevations referenced in this report are based on a datum that was established during a LiDAR survey carried out in 2012. The original site datum used to design and build the structures in the early 90's was about 2 m lower than the 2012 datum. All previous inspection reports, prior to 2014, used the 1990 datum.

SRK Consulting understands that Teck's long-term goal for this tailings facility is to reach landform status with all potential failure modes being reduced to non-credible. The likelihood of the key failure modes at the site is very rare based on extreme consequence loading conditions and conservative assumptions. Whether the failure modes are credible or non credible will be evaluated in a future study that will verify or refine the conservative assumptions.

1.2 Regulatory Requirements and Guidelines

This report addresses the performance of the TMA, the associated water management infrastructure including the Jewelbox and Main Zone open pits, and the Jewelbox, Main Zone and Burnick waste rock dumps. The work was completed in accordance with the following regulatory requirements and guidelines, which in combination, fall within Teck's internal requirements included in Teck's Tailings and Water Retaining Structures (TWRS) guideline and policy (2019):

- Canadian Dam Association (CDA) Dam Safety Guidelines 2007 (2013 Edition)
- Canadian Dam Association (CDA) Application of Dam Safety Guidelines to Mining Dams. Technical Bulletin, 2014
- The Yukon Territory Sä Dena Hes Water License (QZ99-045). New License issued April 2017 (QZ16-051)
- The Yukon Territory Sä Dena Hes Quartz Mining License (QML-0004)

While the report focuses on the TMA, the waste rock dumps are included in the inspection in accordance with Clause 45 of the current Water License (QZ16-051).

1.3 Facility Description

1.3.1 Overview

This section provides a description of the components remaining at the mine site after the TMA was decommissioned in 2014 and 2015. A map showing the overall mine site is provided on Figure 1. A general arrangement map of the TMA is provided in Figure 2.

1.3.2 North Dam

The North Dam is approximately 15 m high with a crest elevation of 1,100 m, a crest length of about 260 m, and a crest width of 10 m. A site plan and section through the dam are shown in Figures 3 and 4. The North Dam for this report is considered a mining dam as it is a barrier constructed for the retention of tailings (CDA 2014).

Most of the tailings lie within the northern half of the TMA above the original cofferdam, which has since been removed. The tailings behind the North Dam were capped with a till cover in 2014. The cover was graded flush with the crest of the dam and graded south toward the SRS. A few small low lying areas remain within the cover that seasonally collect water, but overall the North Dam has not retained water since the mine decommissioning was completed. Given the cover grades away from the dam crest, the dam would only need to retain ponded water under extreme conditions as discussed below.

In 2016, SRK carried out a hydrological study (SRK 2017) to assess the likelihood of overtopping of the North Dam in the event of a design flood event. The results indicated that during an extreme case, such as the Probable Maximum Flood (PMF), the North Dam crest is not overtopped and therefore is not a credible failure mode. Although the backwater effect arising from a blockage scenario in the central channel does result in an increased flood extent, with ponded water reaching within a few centimetres of the dam crest, an overtopping scenario is not reached. The maximum depth of water would vary from 0.5 m in the central channel to less than 0.1 m adjacent to the upstream crest of the dam. The model predicted that during the peak of the event, water would only be lapping up against the dam for about 12 hours before it dissipates. The minimum freeboard adjacent to the low point along the upstream edge of the crest at the peak of the event varied from 5 to 8 cm.

1.3.3 Sediment Retaining Structure (SRS)

The SRS was constructed by leaving in place a low-profile dike composed of the former South Dam toe material. The structure is considered temporary and Teck plans to remove the structure in the future. The primary function of the SRS is to retain any sediment that may be transported from the till cover over time. A visual inspection from the perimeter of the pond indicated that there has been some accumulation of sediment in the pond since the reclamation work in 2015. No sounding of the actual depth of the sediment has been carried out.

The dike is approximately 80 m in length and has a crest width of 4 m at an approximate elevation of 1,087.7 m. The upstream face of the SRS was graded to 2H:1V and the downstream face was graded to 2.5H:1V. While the SRS is only about 7 m high, for this report it is also considered a mining dam as it is a barrier constructed for the retention of ponded water (CDA 2014). The depth of water behind the structure is a maximum of about 1.7 m.

An emergency spillway was constructed through the dike to accommodate the 1 in 1000-year Inflow Design Flood (IDF) event (5.4m³/s) and to convey runoff from the upstream catchment to the South Drainage Channel. The as-built spillway and drainage channel geometries are presented in Figures 5 and 6. The spillway channel invert elevation is 1,085.7 m and has a length of 33.3 m.

1.3.4 Water Management Infrastructure

Overview

Three drainage channels were built as part of the 2014 TMA decommissioning (see Figure 7). The longest of the three was constructed through the former Reclaim Dam and the pond area to route Camp Creek flows along its historical alignment. The other two drainages (the North Channel and the South Channel) were constructed to direct runoff from the covered tailings areas to the new Camp Creek Drainage Channel. There is also a drainage channel located down the middle of the cover that directs runoff from the tailings cover at the northern end of the TMA.

South Drainage Channel

The South Drainage Channel was constructed from the SRS spillway through the former South Dam and connects with the Camp Creek Drainage Channel. The channel length is about 230 m and it was installed with riprap erosion protection placed on top of a non-woven geotextile (see Figure 8). The channel is designed for the 1 in 1000-year IDF. Upstream and downstream side slopes are 2:1 (H:V). Average grade of the channel is 0.04.

Camp Creek Drainage Channel

The Camp Creek Drainage Channel was constructed through the former Reclaim Dam and pond area to route Camp Creek flows along its historical alignment (see Figure 8). The channel length is about 940 m and it was installed with riprap erosion protection placed on top of a non-woven geotextile (see Figure 8). The channel is designed for the 1 in 1000-year IDF. Upstream and downstream side slopes are 2:1 (H:V). Average grade of the channel is 0.05.

North Drainage Channel

The North Drainage Channel was constructed along the east side of the former South Pond to convey water from the North Tailings Area to the SRS. Conveyed water is detained in the SRS to allow for sediments to deposit before the water is discharged into Camp Creek (see Figure 9). The channel length is about 300 m and it was installed with riprap erosion protection placed on top of a non-woven geotextile. The channel is designed for the 1 in 1000-year (IDF). Upstream and downstream side slopes are 2:1 (H:V). Average grade of the channel is 0.03.

North Creek

During operation of the mine, a dike was built over the North Creek as a water storage facility for the mill. The dike (see Figure 1 for location) was decommissioned in 2015 and a riprapped channel was built through the old dike to convey the flow along North Creek to False Canyon Creek. A similar channel was also built downstream to convey the North Creek flow through a decommissioned access road.

1.3.5 Tailings Cover

The soil cover over the tailings discussed previously varies up to 2.2 m in thickness. It covers all the exposed deposited tailings, specifically in the North Tailings Area and the tailings deposited in South Pond area. The cover was constructed of excavated dam fill material. It provides an effective means of controlling wind erosion of tailings and a growth medium over the tailings for revegetation. The cover was sloped away from the crest of the North Dam in a southerly direction towards the SRS. Water is no longer impounded behind the dam. A shallow swale was constructed down the middle of the cover to direct surface runoff on the cover to the SRS.

The total covered area of the TMA is 155,081 m². The reclaimed North Tailings Area is 87,745 m², the reclaimed South Pond including the grassy area is 28,444 m², and the reclaimed Reclaim Pond is 38,892 m².

1.3.6 Waste Rock Dumps

During operation of the mine, waste rock dumps were developed at each of the main portals, associated with the Main Zone, the Jewelbox Zone and the Burnick Zone ore bodies. At closure, the portals were closed off with waste rock, and the dumps were resloped to direct runoff away from the openings and to provide more stable conditions.

1.4 Summary of History

The Sä Dena Hes mine was constructed in 1991 and operated for a 16-month period between August 1991 and December 1992. The Sä Dena Hes Operating Corporation (SDHOC) purchased the property from Curragh Resources Inc. in March 1994. The Sä Dena Hes Mining Corporation (the Company) is a joint venture between Teck Resources Limited (“Teck” - 50% ownership) and Pan Pacific Metal Mining Corp (50% ownership, a wholly owned subsidiary of Korea Zinc.) Teck is the operator and manages the property under the joint venture agreement.

2 Maintenance and Surveillance during 2019 to 2020

After the 1992 shutdown of the mine, it never reopened, and no more tailings were deposited into the TMA. Information on the decommissioning of the mine is provided in Section 1.4.

Teck conducts on-going maintenance and surveillance of the TMA and the water management infrastructure at the site including the access road from the Robert Campbell Highway. Any trees or vegetation on the downstream slope of North Dam that do not conform to the guidelines in the Sä Dena Hes OMS manual are trimmed or removed. Seepage at the toe of the North Dam is monitored monthly with sampling of water quality and measurement of flow. During the monthly inspections by the sampling team, an inspection of the North Dam and the SRS spillway is made to check for any blockages or subsidence.

3 Climate Data and Water Balance

3.1 Review and Summary of Climate Data

This section presents the current climate data for the site. As there is no weather station at the site, the data from selected local meteorological stations was used to determine the mean annual precipitation and evaporation for the site. Below reference is made to a detailed climate characterization study that was carried out by SRK (SRK 2017) to determine mean annual total precipitation for the Project site in absence of any site-specific data.

3.1.1 Mean Annual Precipitation

A regional and regression analysis was performed using the nearby meteorological stations from Environment and Climate Change Canada (ECCC). The data was compiled in R Studio Software, generating the mean annual precipitation (MAP) for each station. Table 3-1 presents the station locations relative to the site, as well as their respective MAP estimate. Correction for under-catch in the precipitation measurements is prepared daily by ECCC for many, but not all meteorological stations, as noted in Table 3-1.

Table 3-1: Selected Meteorological Stations Associated with the Project Site (1960 to 2016)

Station ID	Station Name	Longitude [deg]	Latitude [deg]	Elevation [m]	Dist. from Site [km]	MAP [mm]	Years of Info [yrs]	Under-Catch Factor Available
2101200	Watson Lake A	-128.82	60.12	687.4	46.66	424.0	74	YES
2101135	Tuchitua	-129.22	60.93	723.9	47.90	493.6	40	YES
2100FCG	Hour Lake	-129.13	61.18	890.0	72.93	544.8	28	NO
2101081	Swift River	-131.18	60.00	891.2	141.74	564.7	37	YES
1191440	Cassiar	-129.83	59.28	1077.5	150.35	728.2	36	YES
1197530	Smith River A	-126.43	59.90	673.0	151.68	466.9	25	NO
2203922	Tungsten	-128.25	61.95	1143.0	160.38	637.0	22	NO
2101100	Teslin A	-132.74	60.17	705.0	217.87	332.9	56	YES
1192340	Dease Lake	-130.01	58.43	806.6	243.67	419.9	61	YES
1195250	Muncho Lake	-125.77	58.93	836.5	248.96	508.1	40	NO
2100200	Carcross	-134.70	60.17	660.0	324.42	248.4	60	NO
1208202	Todagin Ranch	-130.07	57.60	899.0	334.45	419.4	18	NO
2100460	Drury Creek	-134.39	62.20	609.0	348.27	372.9	35	YES

Source:
 file:///Z:/01_SITES/Sa_Dena_Hes/1CT008.061_2016_DSR_Studies/Task%20100_Hydrology/R_Analysis/Hydrology/Precipitation_Hydrology_at_Sa_Dena_Hes.docx

The regression analysis predicted a MAP for the site of 646 mm based on an elevation of 1080 masl. Monthly average precipitation for the site is summarized in Table 3-2 based on the site MAP of 646 mm and the monthly distribution from the Cassiar station (SRK 2017).

Table 3-2: Monthly Average Precipitation for the Site

Location	Jan	Feb	Mar	Apr	May	Jun	Jul	Aug	Sep	Oct	Nov	Dec	Annual
Site	58.1	49.1	39.4	23.9	33.6	47.8	60.7	63.3	71.7	75.6	58.8	64.6	646

3.1.2 2019-2020 Analysis

An estimate of the Aug 2019 to July 2020 MAP for the site was computed and used to estimate the 2019 to 2020 Water Discharge Volumes at the SRS spillway.

The Watson Lake A station was used as the reference station as it is the most representative station close to the site that is currently active. Total precipitation recorded at Watson Lake A from Aug 2019 to July 2020 was reported as 306 mm by ECCC. Using the undercatch correction factor of 1.13 (SRK 2017), total corrected annual precipitation at Watson Lake for the same period was 345.8 mm.

A ratio of Watson Lake MAP vs. calculated site MAP was applied to convert the corrected 2019-20 Watson Lake airport precipitation to a representative MAP for the site. Based on the corrected undercatch MAP for Watson Lake of 454 mm (see Table 5.1 in Appendix A of SRK 2016a), the adjustment factor for the site is 1.42, which equates to an approximate annual precipitation of 491 mm at the site from August 2019 to July 2020 as shown in Table 3-3.

Table 3-3: 2019-20 Monthly Precipitation for the Site (based on Watson Lake Data)

Location	Aug	Sept	Oct	Nov	Dec	Jan	Feb	Mar	Apr	May	Jun	Jul	2019-20 /Annual
Site	82.3	40.1	24.9	42.0	25.8	32.6	55.5	25.7	8.0	48.6	61.6	43.8	491

3.1.3 Evaporation

The network of evaporation stations is sparse in the Yukon and northern British Columbia. Potential evapotranspiration was calculated using the Morton (1983) methodology, utilizing meteorological parameters measured at the nearby Watson Lake weather station, with solar radiation data obtained from the Whitehorse Airport station. Using this method, the annual lake evaporation rate was estimated to be 483 mm as shown in Table 3-4. Due to the limited variability of lake evaporation from year to year, the average annual values are applied in the annual water balance.

Table 3-4: Mean Monthly Lake Evaporation

	Jan	Feb	Mar	Apr	May	Jun	Jul	Aug	Sep	Oct	Nov	Dec	Year
Morton-Shallow Lake [mm]	10.4	8.4	18.2	41.4	75.5	96.9	99.5	71.6	33.4	11.0	7.2	9.7	483.2

Source://Z:\01_SITES\Sa_Dena_Hes\1CT008.057_2016_Geotech_Inspection\080_Deliverables\1CT008.057_Report\010_Text\2016_SDH_GeotInsp_Report_1CT008-057_20170404_pmh.docx

3.2 Review and Summary of Water Balance

The TMA at Sä Dena Hes has been decommissioned and there are no active ponds other than the small sediment pond at the SRS. The SRS pond has a maximum surface area of about 1600 m² during the freshet high flow period. An emergency overflow spillway was also built through the SRS to accommodate the 1 in 1000-year flood event. The catchment area for the SRS spillway is 1.33 km² as shown on Figure 10.

A simplified mean annual average water balance calculation for the catchment above the SRS dike is summarized below, based on data compiled for the recent SRK hydrological study (SRK 2017) and the following assumptions:

- Inflow from the surrounding hillside catchment (1.17 km²) based on 60% of the MAP;

- Inflow from the tailings till cover (0.16 km²) based on 50% of the MAP; and
- Direct precipitation input to the SRS pond based on 100% of the MAP.

Outflow from the SRS pond based on annual pond evaporation (483 mm) and seepage losses (estimated at 0.5 l/s).

Using the estimated 2019-2020 MAP for the site, the 2019-2020 water year, water balance is shown in the following table.

Table 3-5: Summary of Site Water Balance (2019-2020)

Item	Units	Mean Annual Based on 25 Years of Record	2016	2017	2018	2019-2020
Area of Hillside catchment	(km ²)	1.17	1.17	1.17	1.17	1.17
Area of Sediment Pond	(km ²)	0.0016	0.0016	0.0016	0.0016	0.0016
Area of Tailings Cover Material	(km ²)	0.156	0.156	0.156	0.156	0.156
MAP	mm	646	442	503	355.6	491.0
Mean Annual Lake Evaporation	mm	483	483	483	483	483
Hillside Runoff Coefficient		0.6	0.6	0.6	0.6	0.6
Tailings Cover Runoff Coefficient		0.5	0.5	0.5	0.5	0.5
Pond runoff Coefficient		1	1	1	1	1
MAR from the hillside catchment above the SRS	m ³	453,492	310,284	353,106	249,631	344,687
MAR on the sediment pond surface	m ³	1034	707	805	569	786
MAR from tailings cover material	m ³	50,388	34,476	39,234	27,737	38,299
Total Annual Inflow	m ³	504,914	345,467	393,145	277,937	383,772
Annual pond evaporation losses	m ³	772.80	772.80	772.80	772.80	772.80
Seepage Losses	m ³	15,768.00	15,768.00	15,768.00	15,768.00	15,768.00
Total Outflow	m ³	16,540.80	16,540.80	16,540.80	16,540.80	16,540.80
Net Annual Discharge Volume (over spillway)	m ³	488,372.80	328,926.40	376,604.00	261,396.16	367,230.74

3.3 Freeboard and Storage

3.3.1 North Dam

The 2016 hydrological studies completed by SRK (SRK 2016a) estimated that during an “extreme worst case” probable maximum precipitation (PMP) event with none of the existing drainage features such as water diversions functioning, there would still be a freeboard above the maximum ponded water of between 5 to 8 cm.

3.3.2 SRS

The SRS dike has a 1 m freeboard above the 1 in 1000 year flood event to the crest of the dike.

3.4 Water Discharge Volumes

The current water license does not have provision for regulating the volume of water discharging over the SRS spillway. However, with reference to the above water balance, the estimated annual water discharge volume through the SRS spillway for August 2019 to July 2020 was 367,231 cubic metres.

3.5 Water Discharge Quality

The surface water quality discharging from the TMA is currently monitored annually under the Yukon Water License QZ16-051. The groundwater quality is currently monitored under the same license. In 2020, samples from all the required water quality monitoring stations were collected and analyzed. The results demonstrated that all the surface and groundwater stations met the standards provided in the water license QZ16-051.

Under the current water license QZ016-051, water quality in the sediment pond is not required to be monitored. However, Teck has re-established the water quality sampling location within the pond in preparation for the eventual decommissioning of the SRS dike.

4 Site Observations

4.1 Visual Observations

The weather during the MWF on July 28, 2020 was cool and wet. Routine inspections of the TMA are made by Jeff Basarich twice a year in the spring and the fall. Observations made by Mr. Basarich were reviewed by SRK.

No safety concerns related to the North Dam and the SRS were identified during review of the photos and reports prepared by the Mr. Basarich.

4.1.1 North Dam

A site plan and a section of the North Dam are presented on Figures 3 and 4.

The crest of the North Dam looking west is shown in Photo 1 (Appendix A). The dam is in good condition and shows no signs of deformation or abnormal settling. The downstream slope of the dam (Photo 2) shows no signs of surficial movement or erosion nor is there any sign of bulging at the downstream toe. While there are a few shrubs and small trees on the slope, no excessive vegetation growth beyond the guidelines in OMS was noted.

The piezometers and settlement gauges on the North Dam are in good condition and continue to function as designed. Photo 3 shows the protective steel cap at the location of the NDW 3A. The orange coloured piezometer caps provide visible identification for the monitoring team as

illustrated in Photo 4. Photo 5 shows the now redundant steel displacement pins protected by a steel barrel.

Along the downstream toe of the North Dam there is an 80 m long seepage zone. Seepage from this zone is collected at a monitoring station referred to as MH-02 and is a combination of groundwater discharge from the surrounding hillsides to the west and minimal seepage flow from the impoundment. The monitoring station consists of a 6-inch diameter steel pipe (Photo 6) embedded in sandbags. At the time of the inspection it was noted that the pipe had been displaced and will need to be adjusted. No change in the flow rate or consistency of the flow was noted during the site visit or during the routine site inspections and water quality sampling.

4.1.2 Till Tailings Cover

The till tailings cover has overall downward gradient away from the North Dam. A swale was constructed within the cover to assist in directing runoff away from the crest of the North Dam. The swale was clear of any debris or vegetation although there was evidence that water has flowed in the swale.

As planned, vegetation is slowly developing over the entire area of the cover as shown in Photo 1.

4.1.3 Sediment Retaining Structure

The Sediment Retaining Structure (SRS) was built during the decommissioning of the South Dam between 2014 and 2015. The structure is considered temporary and Teck plans to remove the structure within the next 5 years. The primary function of the SRS is to retain any sediment that may be transported from the till cover over time.

Photo 7 shows a view looking west over the dike crest. The photo also shows the vegetative growth on the downstream face and the vegetative geogrid mat. Figures 5 and 6 provide a site plan and sections of the SRS. Photo 8 shows a shallow erosion rill in downstream face just west of the spillway.

The rock cofferdam and the sedimentation pond are functioning well. The sedimentation pond was clear at the time of our inspection with no evidence of any silt buildup.

The emergency spillway at the SRS is stable and has no safety concerns.

4.1.4 Drainage Channels

The riprapped drainage channels (the North channel, the Camp Creek channel and the South channel) were constructed during the TMA decommissioning in 2014. Photo 9 is a view looking south along the South Drainage channel. Figure 7 provides a plan view of the three channels. SRK inspected each of the channels for any signs of major subsidence and movement of the riprap erosion protection. Both the South drainage channel and the Camp creek drainage channel are functioning as designed with no significant deterioration.

The North Drainage channel upstream of the SRS (Photo 10) was built to divert as much runoff as possible away from the tailings and soil cover during the first few years after the cover placement. Most the channel remains in stable condition except for a subsidence that has occurred about 50 m upstream of the channel outlet. (see Photos 11 and 12). It appears that seepage from the hillside above the channel triggered the subsidence and threatens to undermine the structure at that location. While this is not considered a risk to the SRS dike and once the SRS is removed and the vegetation on the cover takes hold, no maintenance of the channel will be required. However, as no immediate plans are in place to breach the SRS, the subsidence should be repaired by buttressing with riprap borrowed from the downstream portion of the North Drainage channel.

4.1.5 North Creek

A riprapped channel conveys the North Creek over the original location of the decommissioned North Creek Dike. It was noted during the MWFI that at the inlet of the channel, beavers had again built a dam which restricted the flow. The dam raises the water level of the pond nominally and could potentially increase the risk of a rapid release of water which could result in erosion of the riprap protection in the channel. However, there are no downstream structures that are at risk if the beaver dam was to breach. Best practice dictates that beaver dams be removed when identified during the routine inspections.

About 150 metres east downstream of the above channel is a second riprapped channel that was reclaimed following the removal of two culverts as part of the site reclamation in 2015.

On the north side of the channel at the second crossing of the North Creek, it was noted (see Photo 13) that high flows have eroded the bank resulting in unstable conditions in the existing road fill that was placed during the mine operation. North Creek will continue to erode this section of the channel area but will eventually sustain itself without maintenance. No remedial action is required.

4.1.6 Landfill, Burnick and Jewelbox Waste Rock Dumps

SRK inspected the old landfill area south of the North Dam, the resloped Main Zone and Jewelbox waste dumps (Photo 24) shown in Figure 12.

As shown in Photo 14, a small sink hole was observed in the landfill. The surface opening is about 180mm in diameter and is about 50cm deep. The landfill poses no risk to the stability of the North Dam or any other tailings and water management structures on site.

SRK also inspected the Burnick waste dumps at the locations of the reclaimed 1200 and 1300 portals respectively as shown in Figure 11. During the site decommissioning in 2014, the dumps were recontoured to provide added long-term stability. No further subsidence of the slopes was noted. Minor settlement of the fill that was placed over the 1200 portal has resulted in a shallow tension crack in the fill (see Photos 15 and 16). This crack was noted in previous inspections. No action is required.

At the low point of the Jewelbox waste rock dump, the 2 to 3 m deep erosion gully that has been monitored over the last few years showed some deterioration since last year but was beginning to show signs of self armouring (See photos 17 and 18). The monitoring pins which were installed to gauge whether the gully was deepening have been displaced. There is no impact on the stability of the dump and other than re-establishing the pins, no action is required.

A view of the TMA from the Jewelbox dump is shown in Photo 19.

Two to three shallow openings were observed in the pit wall at the Main Zone area. These openings may have been caused by internal subsidence but currently do not pose a safety concern (see Photos 20 and 21).

4.2 Photographs

A photographic log was taken during the site inspection. Photos are provided in Appendix A and are referenced in Section 4.1.

4.3 Instrumentation Review

4.3.1 Water Levels

The water levels in the North Dam piezometers are recorded bi-monthly and the results are reviewed by the EoR after each monitoring session. Figure B1 in Appendix B provides a plot of seasonal water levels from 2011 for Piezometers NDW-1A, 2A, 3A and 4A. The chart shows the acceptable alert level criteria which is provided in TECK's Trigger Action Response Plan (TARP).

The piezometers are in good condition and continue to function as designed. The seasonal fluctuations recorded in the latter part of 2019 and 2020 in the piezometers are consistent with those in previous years with the exception of readings taken on May 29, 2020 and August 25, 2020 which saw levels in Piezometer 2A trigger an alert indicating exceedance of the acceptable alert level. A review of the data was carried out including a comparison with adjacent groundwater wells levels and local rainfall data at the time. The unexpected rise in the Piezometer 2A water levels was also observed in the other piezometers and in the adjacent groundwater wells around the site. The initial spike in the water level in Piezometer 2A in late May 2020 was attributed to a deeper snow pack than usual and a slower melt rate. The second rise recorded in August 2020 was consistent with heavier than normal rainfall. Subsequent readings are more consistent with trends seen in previous years.

The peak levels recorded in June 2020 are plotted on the dam section shown on Figure 4.

4.3.2 Deformation/Settlement

The readings taken of the settlement gauges in the North Dam indicate that there has been no unexpected settlement of the embankment over the 27-year period that readings have been taken.

Teck has been surveying the settlement gauges on the North Dam since 1993. Results are shown on Table 4-1. The results are elevations taken from the top of the steel pins that were set within the crest of the dam during construction. The last set of readings taken using the 1990 datum was completed in 2010. A recent set of readings was completed in 2017 based on the 2012 datum. The readings are consistent with those observed in previous years, with settlement readings varying to a maximum of 51 mm (or less than 1% of the total height of the dam) from the initial readings taken in 1993. The recorded settlements are considered normal deformation for a small earthen dam and would not compromise the structural integrity of the dam. In the last 3 years, the settlement changes have been less than 1 mm.

Table 4-1: Summary of Elevations Taken at the top of the North Dam Settlement Gauges

Date	NDS3 (m)	NDS1 (m)	NDS2 (m)
August/93	1098.639	1098.501	1098.613
July/94	1098.637	1098.502	1098.589
August/95	1098.690	1098.545	1098.663
July/96	1098.637	1098.493	1098.609
August/97	1098.637	1098.496	1098.618
October/98	1098.627	1098.482	NA
October/02	1098.619	1098.481	1098.607
June/05	1098.637	1098.479	1098.587
June/06	1098.63	1098.45	1098.57
August/07	1098.786	1098.454	1098.489
June/08	1098.626	1098.482	1098.597
June/09	1098.625	1098.469	1098.587
June/10	1098.59	1098.47	1098.60
August/14	1100.572	1100.412	1100.524
September/15	1100.548	1100.391	1100.512
2016	1100.572	1100.425	1100.547
2017	1100.573	1100.427	1100.547
2018	1100.571	1100.426	1100.546
2019	1100.57	1100.427	1100.547
2020	1100.57	1100.43	1100.55

Note: 2014 to 2020 readings are based on the 2012 datum.

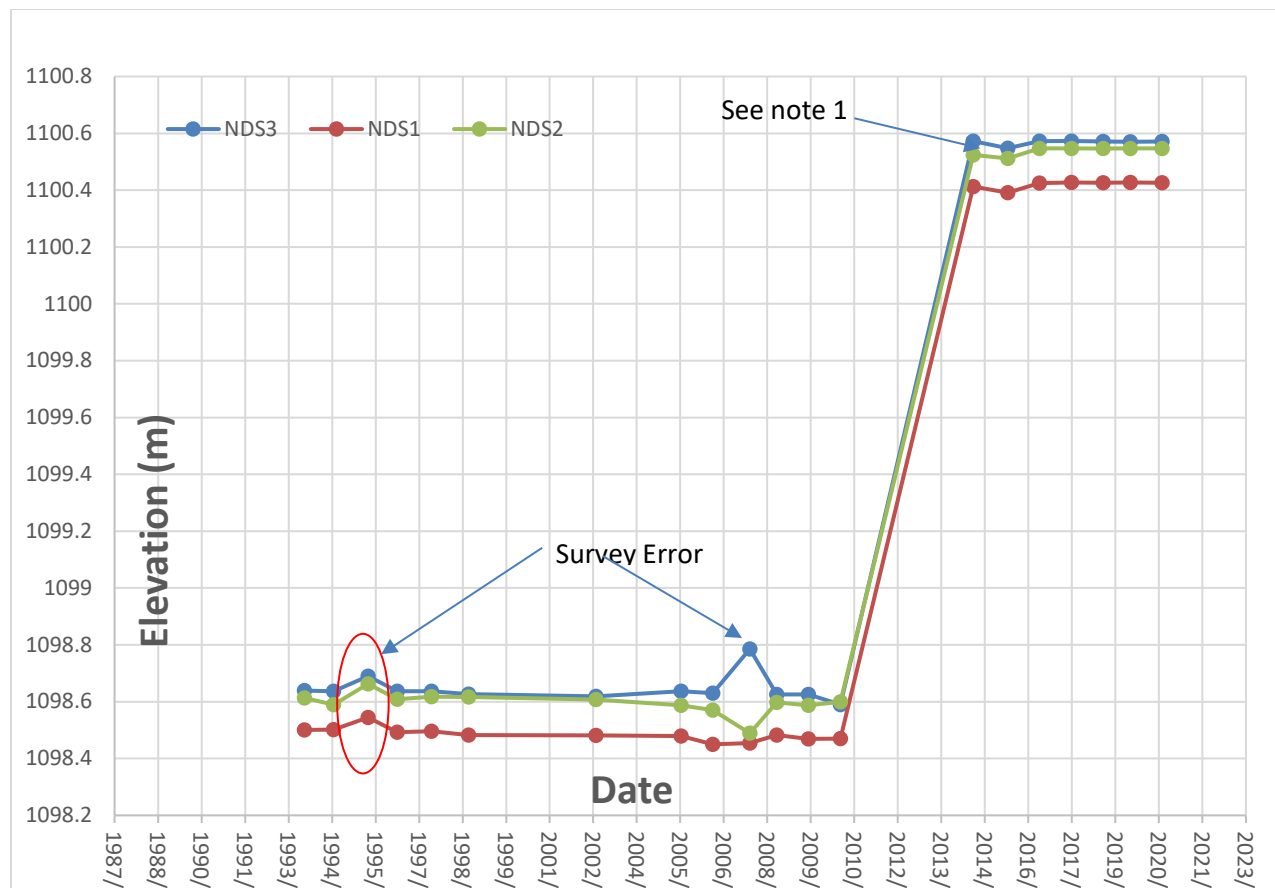

Figure 13: North Dam Settlements

Note 1: Survey Datum was changed in 2012

Figure 13 presents a graphical depiction of the settlement of the crest of the dam over time. The readings taken from 1992 to 2010 were based on the 1990 datum. The 2014 to 2020 readings were based on the 2012 datum. The results shown for 1995 and 2008 are erroneous due to survey error. Furthermore, some of the results indicate an increase in elevation. Those numbers were attributed to the inaccuracy of the survey equipment used and were consequently ignored. In general, as shown by Figure 13 above, settlement of the North Dam is performing as expected.

Given the above results and the long-term trend, no further settlement readings are required.

4.3.3 Stability/Lateral Movement

There is no stability or lateral movement instrumentation installed in either the North Dam or the SRS dike.

4.3.4 Discharge Flows

There is no discharge from the tailings surface behind the North Dam. Runoff from the tailings cover is directed away from the North Dam towards the sedimentation pond located behind the SRS. There is an emergency spillway in the SRS dike but no flow data is recorded. There is seepage from the hillside to the west and minor seepage from the TMA which reports to MH-02.

4.4 Pond and Discharge Water Quality

The Sediment pond at the SRS is the only pond associated with the TMA. Water quality in the pond was monitored as MH-01 under previous Water License QZ16-080 which expired on March 31, 2017. The results of the water sampling carried out for the pond under the QZ16-080 water license met the standards in the water license. Under the current water license QZ16-051, water quality in the sediment pond is not required to be monitored. However, Teck has re-established the water quality sampling location within the pond in preparation for the eventual decommissioning of the dike. MH-02 would continue to be monitored. Compliance points located downstream of the former Reclaim Pond (MH-11) and downstream of the north tailings dam (MH-12) are required to be monitored.

4.5 Site Inspection Forms

In accordance with the site water license, the OMS manual and the EPRP, a routine inspection of the TMA is completed twice a year in the spring and the fall by Jeff Basarich.

4.6 Facility Data Sheet

Facility data sheets for the North Dam and the SRS dike are provided in Appendix C.

5 Facility Safety Assessment

5.1 Facility Classification Review

The first assessment of the Consequence Classification (CC) of potential failure of the dams and spillways associated with the TMA was completed by SRK for the 2000 Detailed Decommissioning Reclamation Plan (DDRP). The assessment was completed in accordance with the guidelines presented in the “Mine Reclamation in the Northwest Territory and the Yukon” (INAC 1992) and focused on the failure of the South Dam spillway and the failure of the North Dam. The failure of South Dam and the Reclaim Dam was not considered since they would be removed upon closure. The study concluded that the failure of the North Dam and the South Dam spillway would not pose a significant risk to public health and safety; there would be no loss of life expected, no damage to buildings and no loss to roads. The design criteria established for the design of the South Dam spillway and the stability of the North Dam was therefore based on the 1 in 1000-year IDF and the PGA for the 1 in 1000-year seismic event, respectively. No dam breach or inundation studies were carried out as no failure modes would lead to impacts of concern. Further, there are no credible catastrophic failure modes present as described in this overall review.

As part of the 2003 Dam Safety Review (DSR) completed by Klohn Crippen Berger (KCB), a screening level assessment of the CC for the TMA was carried out so that the appropriate design criteria could be established for the DSR. The assessment was carried out in accordance with the 1999 CDA Dam Safety Guidelines and included a dam breach inundation analysis. The study concluded that all three dams (North, South and Reclaim) would be classified as Low Consequence facilities.

In 2010, a second DSR was carried out by Golder Associates, who also completed a screening level assessment so that design criteria could be established for the 2010 DSR. The assessment was completed in accordance with the CDA 2007 Dam Safety Guidelines and included a conceptual dam breach and inundation study. Overall the assessment concluded that all three dams would be in the “significant” consequence class due to the potentially significant incremental losses on False Creek and Frances River.

Given the 2014 decommissioning activities associated with the TMA, SRK completed a dam breach and inundation study for the SRS dike and the North Dam. The assessment concluded that by applying the CDA (2014) generalized guidelines shown in Table 5-1, incremental losses from a breach of the North Dam and SRS dike would place the structures in the “Low” Consequence class. The attribution of that class to the North Dam and the SRS is based on the following consequence criteria:

- There is no population at risk downstream of the facility or near the dam or in the expected path of any water releases;
- No loss of human life would be expected from the failure;
- No local or regional infrastructure or services would be impacted by a failure; and
- There would be minimal short-term and no long-term environmental and cultural loss.

Table 5-1: CDA (2014) Dam Classification in Terms of Consequences of Failure

Dam Class	Population at Risk [note 1]	Incremental Losses		
		Loss of Life [note 2]	Environmental and Cultural Values	Infrastructure and Economics
Low	None	0	Minimal short-term loss No long-term loss	Low economic losses; area contains limited infrastructure or services
Significant	Temporary only	Unspecified	No significant loss or deterioration of fish or wildlife habitat Loss or marginal habitat only Restoration or compensation in kind highly possible	Losses to recreational facilities, seasonal workplaces, and infrequently used transportation routes
High	Permanent	10 or fewer	Significant loss or deterioration of <i>important</i> fish or wildlife habitat. Restoration or compensation in kind highly possible	High economic losses affecting infrastructure, public transportation, and commercial facilities
Very high	Permanent	100 or fewer	Significant loss or deterioration or <i>critical</i> fish or wildlife habitat Restoration or compensation in kind possible but impractical	Very high economic losses affecting important infrastructure or services (e.g., highway, industrial facility, storage facilities for dangerous substances)
Extreme	Permanent	More than 100	Major loss of <i>critical</i> fish or wildlife habitat Restoration or compensation in kind impossible	Extreme losses affecting critical infrastructure or services (e.g., hospital, major industrial complex, major storage facilities for dangerous substances)

Note 1. Definitions for population at risk:

None – There is no identifiable population at risk, so there is no possibility of loss of life other than through unforeseeable misadventure.

Temporary- People are only temporarily in the dam-breach inundation zone (e.g. seasonal cottage use, passing though on transportation routes, participating in recreational activities).

Permanent- The population at risk is ordinarily located in the dam-breach inundation zone (e.g., as permanent residents); three consequence classes (high, very high, extreme) are proposed to allow for more detailed estimates of potential loss of life (to assist in decision-making if the appropriate analysis is carried out).

Note 2. Definitions for population at risk:

Unspecified- The appropriate level of safety required at a dam where people are temporarily at risk depends on the number of people, the exposure time, the nature of their activity, and other conditions. A higher class could be appropriate, depending on the requirements. However, the design flood requirement, for example might not be higher if the temporary population is not likely to be present during the flood season.

The last DSR was carried out by AMECFW in 2015 and based on this review, the CDA Dam Consequence Classification of the North Dam was changed from “Low” to “Significant”. The change was based on an issue raised by AMECFW noting that there was a potential for liquefaction of the tailings if the dam were to fail and that during a flood event there was a potential for overtopping of the dam. Because of this classification change, the IDF for the North Dam under passive care was changed to 1/3 between the 1,000-year event and the PMF and the design earthquake event was changed from the 1 in 1,000-year event to the 1 in 2,475-year event, respectively (based on passive care guidelines in CDA 2014).

The next DSR is scheduled for 2025 and the form that this review takes will be evaluated following changes that may occur in overall facility safety programs in light of the recently released Global Industry Standard on Tailings Management (ICMM 2020).

5.2 Design Basis Review

5.2.1 North Dam

The original design of the starter dam for the North Dam required a crest elevation of 1,100 m with an ultimate dam design crest elevation of 1,106 m. However, this ultimate design crest elevation was modified in subsequent revisions to the mine plan to El. 1,104 m. A summary of the design criteria for the North Dam is provided in Table 5-2. The design criteria were also updated to reflect changes in the CDA 2014 Technical Bulletin, Dam Consequence Classification.

Table 5-2: Design Criteria of the North Dam (Updated)

Design Crest Elevation (Ultimate)	Not applicable
Starter Dam Crest (Existing)	1,100 m
Top of Till Core Elevation (Ultimate)	Not applicable
Maximum Operating Tailings Level (ultimate)	Not applicable
Maximum Operating Pond Level (Ultimate)	Not applicable
Spillway Invert Elevation	No emergency spillway in dam
Design Operating Freeboard	Not applicable
Design Seepage (SRK/AMCL, 2000)	35-50 L/min
Tailings Storage Capacity (Ultimate)	Not applicable
Dam Consequence Classification (2015 DSR)	Significant
Target Earthquake Level (CDA, 2014) (Passive care) Seismic Event	1 in 2475 year
Target FOS (CDA, 2014)	1.5 (static); 1.0 (pseudo-static)
Target Flood Levels (CDA, 2014)	1/3 between the 1,000-year event and the PMF

Source: \\Z:\01_SITES\Sa_Dena_Hes\1CT008.057_2016_Geotech_Inspection\080_Deliverables\1CT008.057_Report\010_Text\2016_SDH_GeotInsp_Report_1CT008-057_20170404_pmh.docx

5.2.2 Sediment Retaining Structure

The SRS spillway was designed to accommodate the 1 in 1000-year design flood. The SRS currently has a “Low” Consequence Classification. CDA (2014) recommends that the inflow design flood (IDF) for a low consequence dam class that is expected to remain in Construction, Operation & Transition Phase would be the 1 in 100-year event as referenced in Table 3-2 of the CDA 2014 Technical Bulletin. However, as the SRS will be in a “Closure-Passive Care Phase” for an extended period under infrequent surveillance, the IDF for the spillway was raised to the next highest dam classification level, the 1 in 1000-year event as referenced in Table 4-1 of the CDA 2014 Technical Bulletin.

A summary of the design criteria for the SRS is provided in Table 5-3 below.

Table 5-3: Design Criteria for the SRS

Original Design Crest Elevation	El. 1086.7 m
As Built Crest Elevation	El. 1087.7 m
Original Design Spillway Invert Elevation	El. 1085.0 m
As Built Spillway Invert Elevation	El. 1085.7 m
Crest Length	80 m
Design Operating Freeboard	1 m
As Built Operating Freeboard	1 m
Dam Consequence Classification	Low
Operating Pond Level	El. 1085 m
Target Earthquake Level (CDA 2014) (Passive Care)	1 in 1000 years
Target FOS (CDA 2014)	1.5 (static); 1.0 (pseudo-static)
Target Flood Levels (CDA 2014) (Passive Care)	1 in 1000 years

5.3 Hazards and Failure Modes Review

As a permanently closed site, structures at Sä Dena Hes mine site that have the potential to endanger human life or create environmental damage were either removed or upgraded to enhance long-term physical stability. This section of the MWF I reviews the hazards that have been identified for the North Dam and the SRS and provides an assessment of the safety of these structures relative to the potential failure modes listed in the CDA (2014) Technical Bulletin.

Key hazards identified for the North Dam and SRS include runoff from extreme precipitation events, seismic events, ice buildup and debris in the SRS spillway, potential for liquefaction of the tailings and flow capacity of the SRS spillway. The following sections assess the potential failure modes for each structure.

5.3.1 Dam Overtopping

The hydrological studies completed by SRK in 2016 (SRK 2016a) concluded that there is no credible overtopping risk of the North Dam even in an “extreme worst case” probable maximum precipitation (PMP) event with none of the existing drainage features such as water diversions functioning.

The spillway in the SRS is designed to accommodate the 1 in 1000-year IDF which meets the CDA 2014 target levels for flood hazards for “low” Dam Consequence Classification dams in the closure-passive care phase.

5.3.2 Internal Erosion

North Dam

The North Dam was built as a tailings retaining structure designed to allow seepage through the dam. The dam has three zones: an upstream low permeability compacted zone of silty till, a semi pervious compacted central zone of sandy till and a compacted outer downstream shell of pervious sand and gravel. Underlying the dam is a native sandy, gravelly silt (till). There are no indicators of fines being washed through to dam, although there is some seepage evident at the downstream toe. This seepage is mixed in with historical spring activity that was noted during the construction of the dam and the annual dam inspections. The tailings placed up against the upstream face of the dam have significantly reduced the seepage loss since initial construction. Piezometric levels in the dam and in the foundation have varied seasonally since the mine shut down in 1992 and lower levels are expected over time as the till cap consolidates.

The hydraulic gradient across the North Dam is in the range of 0.1 to 0.2. The dam material consists of a mixture of silty till to sandy till which is estimated to have a critical hydraulic gradient ranging from 1 to 13. The likelihood of internal erosion as a failure mode is considered to be very very rare based on extreme consequence loading conditions and conservative assumptions. Whether the failure mode is credible or non credible will be evaluated in a future study that will verify or refine the conservative assumptions..

SRS

The pond behind the SRS has a maximum depth of about 1.5 m and the overall hydraulic gradient through the structure is low and corresponds to no piping potential. The seepage through the dike is barely measurable. There is one small boil that has been noted at the downstream toe of the SRS dike, but no loss of fines detected.

5.3.3 Slope Stability

Table 5-4 outlines the minimum factor of safety (FoS) values for mining dams based on the guidelines in the CDA 2014 technical Bulletin. This is just guidance and includes the broad range of both brittle and ductile facilities. The facilities herein are all ductile and, as such, the guidance by CDA is considered conservative.

Table 5-4: Target Levels for Earthquake Hazards/Factor of Safety, 2014 CDA Guidelines

Dam Rating	Care Type ¹	Event	AEP	Minimum Static FoS	Minimum Pseudo-Static FoS
Low	Transition	1 in 100 year	0.01	1.5	1.0
Low	Passive Care	1 in 1000 year	0.001	1.5	1.0
Significant	Transition	1 in 1000 year	0.001	1.5	1.0
Significant	Passive Care	1 in 2475 year	0.0004	1.5	1.0

Notes:

1. Active care assumes regular dam safety reviews, continual dam performance monitoring and the ability to respond to emergencies immediately. Passive care assumes no maintenance or monitoring occurs post-closure.

As the site is expected to remain in the Closure Passive Care phase for an extended period and as there is infrequent surveillance, the passive care targets have been adopted.

North Dam

As discussed above, the North Dam is composed of compacted fill with a pervious downstream shell. The downstream slope is 2.5H:1V. Several stability analyses have been performed on this dam in the last 5 years.

In 2015, SRK completed a stability analysis of the North Dam to supplement a third-party review of the Dam Consequence Category for the dam.

The results of the stability analyses completed on the North Dam, which are shown in Table 5-5, show that the structure exceeds minimum FoS requirements for long-term static and pseudo-static stability for closed dams under passive care classified as having a “Significant” consequence of failure.

Table 5-5: Stability Analysis Results

Case	FoS
Long Term Static	1.6
Pseudo-Static (1 in 100 year)	1.5
Pseudo-Static (1 in 1000 year)	1.3
Pseudo-Static (1 in 2475 year)	1.2

In the above slope stability analysis, the seismic acceleration used in the calculation was one-half of the full Peak Ground Acceleration (PGA) equivalent to 0.1g based on the 2010 NBC SHC. The application of the entire PGA value in the direction of failure is extremely conservative and represents the absolute worst-case scenario.

In 2016, SRK completed an updated post-liquefaction stability analysis of the North Dam. The stability analysis was completed to assess the stability of the North Dam following an earthquake event and assuming liquefaction of the tailings impounded by the dam during the seismic event.

The stability analysis concluded that tailings play no role in dam stability as the critical failure surface runs through the dam, which is constructed of compacted fill.

Based on the above analyses and the current water levels (maximums), the North Dam is stable under both static and seismic assessments. The likelihood of the above failure modes is considered to be very rare based on extreme consequence loading conditions and conservative assumptions. Whether the failure modes are credible or non credible will be evaluated in a future study that will verify or refine the conservative assumptions.

It should also be noted that in March 2019, SRK completed a review of the Qualitative Performance Objections (QPO) for the North Dam. The review involved the development of threshold criteria for water levels within the piezometers and for dam crest settlement. These

criteria have been incorporated into the updated OMS manual. The pseudo-static stability analysis completed for this study was based on the 2015 National Building Code Seismic hazard calculator (NBC SHC) which lists the 1 in 2475 PGA as 0.14g compared to the PGA of 0.2g 2010 SHC used in the 2015 analysis referenced above.

5.4 SRS

SRK also completed a stability analysis of the current configuration of the dike under both static and pseudo-static conditions. The dike has a maximum height of about 7 m and upstream and downstream slopes of 2H:1V slope and 2.5H:1V respectively. The maximum depth of the pond behind the dike is about 1.7 m.

The seismic calculation was completed using a full horizontal loading of 0.15 g (2010 NBC SHC), which was based on the target level for earthquake hazards suggested by CDA 2014 guidelines for a low consequence class dam in the passive care phase. The results of the analysis indicated both the static and pseudo-static FoS exceeded the target values in Table 5-4 above. It is also noted that the PGA based on the 2015 NBC SHC is now 0.08g almost 50% less than the 2010 values.

5.4.1 Surface Erosion

North Dam

SRK completed a study in 2016 to assess the erosion potential of the material on the downstream face. The study concluded that existing sand and gravel material exposed on the downstream face is adequate to withstand the runoff from the 200-year, 24-hour rainfall event without any significant erosion.

SRS

GeoJute fabric protection on the downstream face of the SRS is in good condition and provides adequate protection against surface erosion.

5.5 Review of Downstream and Upstream Conditions

5.5.1 Downstream Conditions (South)

No changes were noted downstream or south of the TMA. The original exit chute shows no sign of increased seepage since Camp Creek was redirected back into the original Camp Creek channel. The vegetation is slowly taking hold. There were no new dwellings or changes in land use noted.

5.5.2 Upstream Conditions (North)

The North Dam is located near an original catchment divide so all conditions are predominantly downstream. An inspection of the conditions north of the North Dam was carried out and no changes were noted. Similarly, to the area south of the TMA, no new dwellings or changes to land use were noted.

5.6 Physical Performance

5.6.1 Geotechnical

The mine is currently closed in passive care. The North Dam is currently stable and does not retain any water. There are no signs of any instability on the crest or the downstream slope. The SRS dike is also stable with no indication of cracks along the crest or sloughing on the upstream and downstream slopes.

5.6.2 Hydrotechnical

The Să Dena Hes mine is in the drainage basin of False Canyon Creek, a left bank tributary of Frances River. False Canyon Creek has a total catchment area of 492 km² and discharges some 55 km above the Frances River and Liard River confluence. Access to the mine development is from the south across the drainage basin of Tom Creek, a left bank tributary of Liard River.

The reclaimed open pits, underground workings and waste rock dumps associated with the Jewelbox ore zones are located near the drainage divide between Tom and False Canyon Creeks. All drainage from the reclaimed Jewelbox and main zone areas is directed to Camp Creek, a steep-gradient tributary of False Canyon Creek that drains the eastern flank of Mount Hundere. The reclaimed Burnick zone is entirely confined in the headwaters of another False Canyon Creek tributary, which has been designated Tributary D. The reclaimed TMA lies in a saddle along the drainage divide between Camp Creek and Tributary E.

Estimates of the Mean Annual Runoff (MAR) at the site range from 215 mm to 330 mm.

Peak flow estimates for the SRS spillway that were used in the decommissioning design report (SRK 2014) are summarized in Table 5-6.

Table 5-6: Estimated Peak flows for the SRS Spillway

Flood Event	SRS Spillway (1.33 sq. km)
Mean Annual Flood (MAF) (m ³ /sec)	0.7
200-year Peak Instant. (m ³ /sec)	4.5
1000-year Peak Instant. (m ³ /sec)	5.4

The emergency spillway in the SRS shows no sign of movement of the riprap or instability. It is functioning in accordance with the design parameters.

5.6.3 Hydrogeological

The Să Dena Hes Property is underlain chiefly by lower Palaeozoic metasedimentary rocks, including both calcareous and non-calcareous pelitic phyllite and limestone. Limestone comprises about five percent of the stratigraphic sequence and consists of discontinuous units which are up to 100 metres thick, and which typically pinch and swell over short distances. The thicker

limestone units can be traced along strike for hundreds of metres. There is evidence locally that the limestone grades laterally into calcareous phyllite.

Intrusive igneous rocks on the property include three suites: mafic to intermediate, intermediate, and quartz porphyry. These intrusives are of limited size, and their age has been estimated at 50 million years. Although larger igneous bodies are not found on the property, it has been speculated that the area is underlain by a granitic pluton of the mid-Cretaceous Selwyn Plutonic Suite.

The sedimentary strata are complexly folded and metamorphosed muscovite-chlorite phyllites of the greenschist facies. Several sets of steeply dipping faults occur on the property which post-date the folding. Most of these faults are thought to have normal displacement; however, some may be strike-slip. On Jewelbox Hill, a shallow-dipping shear zone follows the upper contact of the main limestone/marble body. A prominent conjugate fracture set trending approximately 100 degrees and dipping steeply north and south is an important control of mineralization.

Mineralization on the property is hosted by skarns which are commonly developed along the contact of limestone or phyllite with marble. Most of the important skarns are formed from a limestone protolith; however, there are good examples of skarn development from phyllite and locally from intrusive rocks. The grades of the latter skarns are generally on the low side.

Sulphide mineralization consists mainly of medium to coarse grained sphalerite and galena which are heavily disseminated in skarn layers. Iron sulphide is present in only minor quantities, or is absent altogether. Close to the peripheries of areas of lead-bearing skarn, there is local development of magnetite skarns. These peripheral skarns occasionally contain pyrrhotite and pyrite, and traces of chalcopyrite in some areas.

The mineralized horizons are commonly heavily oxidized to soft incompetent masses of clay, quartz, smithsonite, anglesite and cerussite to a depth of 130 metres, and some oxides have been encountered at depths of 300 metres and more. Locally, smithsonite has been mobilized from the oxidized skarns and deposited in nearby open fractures.

In some areas the phyllites are modestly to intensely hornfelsed, a feature that is broadly associated with skarn mineralization. Hornfelsing is more readily apparent in the calcareous phyllites than in non-calcareous types; consequently, the contact marking the outer limits of the hornfels suggests that the highly altered phyllites may be closely associated with faults or fractures which form conduits for mineralizing (and hornfelsing) fluids.

Soil materials throughout the mine site area are primarily morainal, fluvial or glaciofluvial. Organics overlying morainal or fluvial material occur in wetlands such as the tailings impoundment areas. Upper alpine zones are bedrock while zones of colluvium occur on the steeper upland slopes.

A layer of silty loam or gravely sandy loam supports white spruce and mixed deciduous forests. These moderately well drained soils are slightly acidic to neutral (pH 6.1 to 7.3) with low to moderate organic matter and with a low level of available nutrients. Wetlands supporting black

spruce vegetation have soils of mesic, fibric peat or silty loam. These poorly drained soils are slightly too strongly acidic, have high organic matter and have very little nutrients available. Alpine and subalpine vegetation is found on moderately well drained silty loam or loamy sand. These soils are slightly acid to neutral with low organic matter and with a low level of available nutrients.

5.6.4 Geochemistry

The mineralization at Sä Dena Hes is characterized by zinc and lead sulphides with low concentrations of iron sulphides in association with abundant carbonates. Therefore, acid generation will not occur. Zinc, cadmium and lead leaching are controlled by the oxidation of sphalerite (Zn, Cd) and galena under pH-neutral atmospheric conditions. Breakdown of sphalerite is apparent throughout the site. Acceleration of sphalerite oxidation is not expected in the absence of a mechanism to lower pH. Zinc and cadmium leaching will continue but is not expected to accelerate. Most sources will continue to leach zinc and cadmium at the current rates.

5.7 OMS Manual Review

The current OMS Manual was prepared by SRK in 2015 and has been updated every year since then. The manual was reviewed by SRK in October 2019 and in May 2020. The template for the OMS was updated in the May 2020 review and consequently section references have been removed from the list of changes.

October 2019 changes included:

1. The 2018 monthly precipitation estimates for the site were updated based on 2018 Watson Lake data.
2. Target Earthquake PGA for the SRS was reduced from 0.15 g to 0.08 g based on the 2015 NBC SHC.
3. Target Earthquake PGA for the North Dam was reduced from 0.2 g to 0.14 g based on the 2015 NBC SHC.
4. Alert level criteria for North Dam Piezometers and settlement gauges were added.

May 2020 changes included:

1. Added a table for document control regarding Records Retention Time for tailings and water facilities.
2. Added a RASCI table for tailings management.
3. Updated Organization Chart.
4. Added Roles and Responsibility table.
5. Added Required Proficiency and Training table.
6. Added Document Change Management section.

7. Added Trigger Action Response Plan (TARP) to OMS Appendices.

5.8 Emergency Preparedness and Response Review

Teck is developing a Mine Emergency Response plan (MERP) for Sä Dena Hes, which will replace the Emergency Preparedness and Response Plan. It's currently in draft with the EOR having reviewed the TMA applicable sections. During the 2020 annual inspection of the TMA, a MERP test tabletop exercise was also conducted, which involved a simulated tailings emergency scenario and included the EoR and Teck personnel.

6 Summary and Recommendations

6.1 Summary of Construction and Operation Activities

The site is currently closed and there are no construction or operation activities.

6.2 Summary of Climate and Water Balance

The MAP for the site is 646 mm based on a recent regional and regression analysis performed by SRK using the nearby meteorological stations from Environment and Climate Change Canada (ECCC). An estimate of the August 2019 – July 2020 water year annual precipitation was calculated to be 491 mm based on the precipitation recorded at the Watson Lake airport.

The mean annual lake evaporation for the site remains unchanged at the estimated 483 mm.

6.3 Summary of Performance

The North Dam is currently stable and does not retain any water. There are no signs of any instability on the crest or the downstream slope. The vegetation on the till cover is taking hold and the drainage channel in the middle of the cover is functioning as designed.

The SRS dike is also stable with no indication of cracks along the crest or sloughing on the upstream and downstream slopes.

The spillway shows no signs of movement of the riprap or instability. It is functioning in accordance with the design parameters.

Seepage from the hillside above the North Drainage channel has triggered a subsidence on the west side of the channel and threatens to undermine the structure at that location. This subsidence should be repaired by buttressing with riprap borrowed from the downstream portion of the North Drainage Channel.

6.4 Summary of Changes to Facility or Upstream or Downstream Conditions

There were no significant changes noted of the North Dam or the SRS dike. Similarly, there were no changes to the upstream and downstream conditions to the north and south of the North Dam.

6.5 Table of Deficiencies and Non-Conformances

SRK has completed the 2020 MWF of Sä Dena Hes mine, TMA and water management infrastructure and concluded that the North Dam, the SRS, the diversion channels and the waste rock dumps are in good condition, and there was no evidence of any dam safety issues or concerns.

Table 6.1 and 6.2 provides a summary of deficiencies and non-conformances noted during the 2020 dam safety inspection (MWF). There are no outstanding deficiencies or non-conformances from the 2019 or earlier MWF's.

Table 6-1: Table of Recommendations from the 2019 and 2020 Annual Mine Waste Facilities Inspections

Structure	ID No.	Deficiency or Non-Conformance	Applicable Regulation or OMS Reference	Recommended Action	Priority (Teck 2019)	Recommended Deadline /Status
North Creek Channel	2019-1	Beaver Dam at inlet to channel	Sec. 6.2 and 6.4 of OMS	Remove beaver dam in channel	3	Before end of 2019 Completed September 5, 2019 Closed
North Creek Channel	2020-01	Beaver Dam at inlet to channel	Sec. 6.2 and 6.4 of OMS	Remove beaver dam in channel	3	Before end of 2020 Completed September 2020 Closed
Seepage Monitoring at d/s toe of North Dam at MH-02	2020-2	Gauge displaced	Sec. 7.1.1 and Table 26 of OMS	Re-position pipe gauge	3	Before end of 2020 Completed September 2020 Closed
Monitoring Pins at base of Jewelbox WR Dump	2020-3	Erosion Gully	Sec. 7.1.1 and Table 26 of OMS	Re-establish Monitoring pins	3	Before end of 2020 Completed September 2020 Closed
North Drainage Channel	2020-4	Side wall subsidence	Sec. 6.2 and 6.4 of OMS	Buttress with riprap	3	Before end of 2020 Completed September 2020 Closed



Table 6-2: General Description of Priority Rankings¹

Priority	Description
1	A high probability or actual dam safety issue considered immediately dangerous to life, health or the environment, or a significant regulatory concern.
2	If not corrected, could likely result in dam safety issues leading to injury, environmental impact or significant regulatory action; or, a repetitive deficiency that demonstrates a systematic breakdown of procedures.
3	Single occurrences of deficiencies or non-conformances that alone would not be expected to result in dam safety issues.
4	Best Management Practice as a suggestion for continuous improvement towards industry best practices that could further reduce potential risks. This typically includes ongoing construction items within the appropriate construction cycle.

¹ Based on the Health, Safety and Reclamation Code (HSRC) for Mines in British Columbia (2016 revision).

This report, Sá Dena Hes 2020 Annual Mine Waste Facilities Inspection, was prepared by

Peter Healey, P.Eng.
Associate Consultant



Peter Mikes, P.Eng.
Principal Consultant

All data used as source material plus the text, tables, figures, and attachments of this document have been reviewed and prepared in accordance with generally accepted professional engineering and environmental practices.

Disclaimer—SRK Consulting (Canada) Inc. has prepared this document for Teck Resources Limited. Any use or decisions by which a third party makes of this document are the responsibility of such third parties. In no circumstance does SRK accept any consequential liability arising from commercial decisions or actions resulting from the use of this report by a third party.

The opinions expressed in this report have been based on the information available to SRK at the time of preparation. SRK has exercised all due care in reviewing information supplied by others for use on this project. Whilst SRK has compared key supplied data with expected values, the accuracy of the results and conclusions from the review are entirely reliant on the accuracy and completeness of the supplied data. SRK does not accept responsibility for any errors or omissions in the supplied information, except to the extent that SRK was hired to verify the data.

7 References

- Amec Foster Wheeler Environment & Infrastructure, a Division of Amec Foster Wheeler Americas Limited. 2016. Sä Dena Hes Mine, Tailings Management Facility 2051 Dam Safety Review. Report prepared for Teck Resources Limited. TE133102.5000. February 2016.
- Canadian Dam Association (CDA). 2013 Edition. Dam Safety Guidelines 2007
- Canadian Dam Association (CDA). 2014. Technical Bulletin: Application of Dam Safety Guidelines to Mining Dams, April 2014.
- Canadian Dam Association (CDA). 2016. Technical Bulletin Dam Safety Reviews.
- [ICMM] International Council on Mining and Metals, 2020. Global Industry Standard on Tailings Management, August.
- INAC 1992, Mine Site Reclamation Guidelines for Northwest Territories, 1992
- MEMPR 2013, Guidelines for Annual Dam Safety Inspection Reports (August 2013)
- Morton, F.I. 1983. "Operation Estimated of Areal Evapotranspiration and their significance to the science and practice of hydrology." Journal of Hydrology 66: 1-76
- SRK Consulting (Canada) Inc., 2015a. 2015 Operation, Maintenance and Surveillance Manual for the Tailings Management Area at Sä Dena Hes Mine. Report prepared for Teck Resources Limited. 1CT008.055. October 2015.
- SRK Consulting (Canada) Inc., 2015b. 2015 Geotechnical Inspection, Tailings Management facility, SDH, YT, November 2015.
- SRK Consulting (Canada) Inc., 2016a. Dam Safety Review Technical Studies, Sä Dena Hes Mine.
- SRK Consulting (Canada) Inc., 2016b. 2016 Dam Safety Inspection, Tailings Management Area SDH, YT, November 2016.
- SRK Consulting (Canada) Inc. 2017a. Baseline Hydrology at Sä Dena Hes. December 2017.
- SRK Consulting (Canada) Inc., 2017b. 2017 Dam Safety Inspection, Tailings Management Area SDH, YT, December 2017.
- SRK Consulting (Canada) Inc., 2018. 2018 Dam Safety Inspection, Tailings Management Area SDH, YT, November 2018
- SRK Consulting (Canada) Inc., 2019 Qualitative Performance Objectives, North Dam, SDH, YT, March 2019
- Teck Resources Limited, 2019. Guideline for Tailings and Water Retaining Structures, January 2019.
- Yukon Territory Water Board Water License QZ99-045 for SDH mine (YTWB 2002), and its amendments (YTWB 2005 and YTWB 2010)

Figures

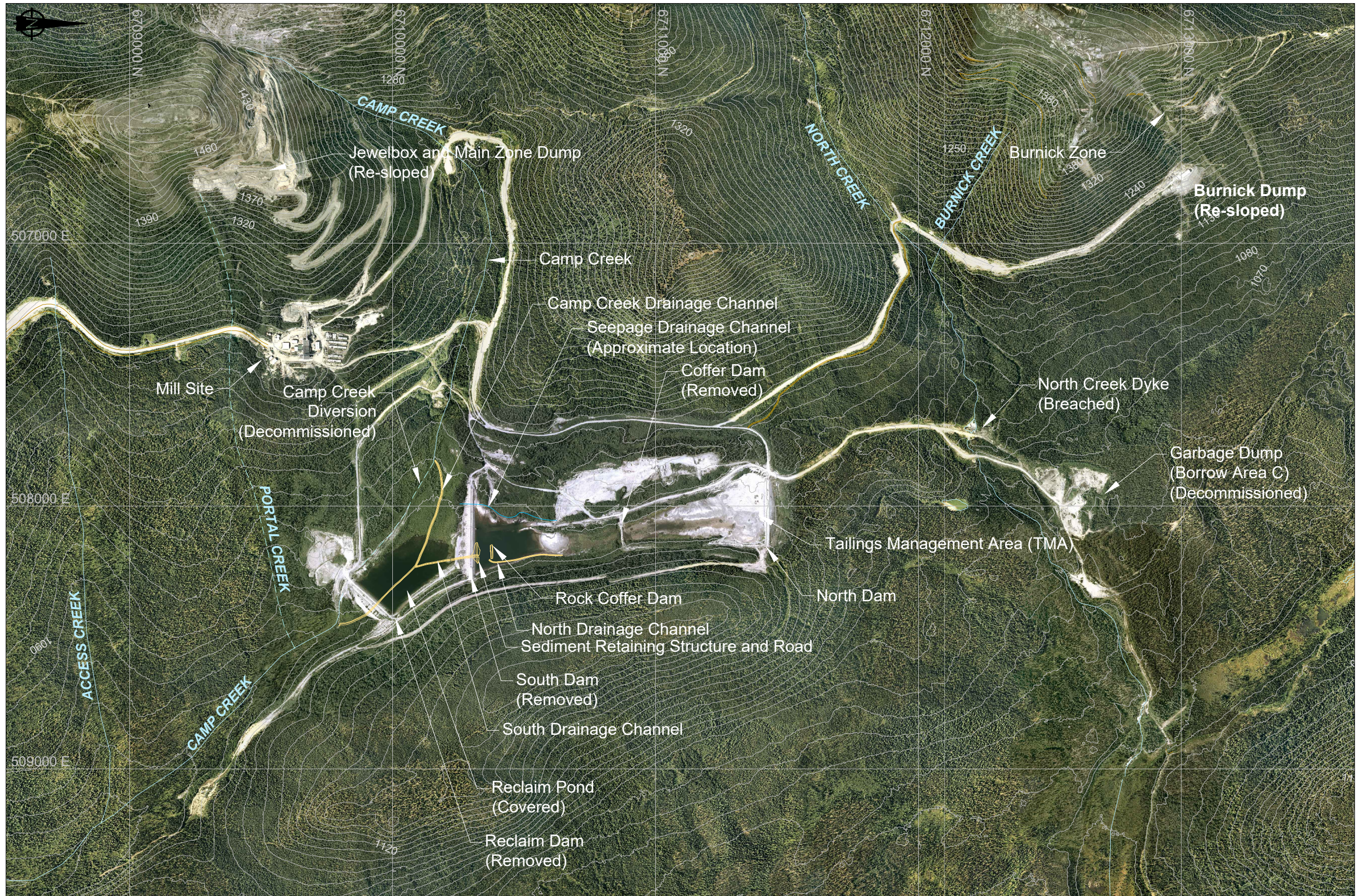

- NOTES**
1. Topographic contour data and aerial photos were obtained from McElhanney and are based on August 15, 2012 LiDAR survey. Coordinate system is UTM NAD 83CSRS zone 9V.
 2. Orthographic photo depicts pre-decommissioned surface.

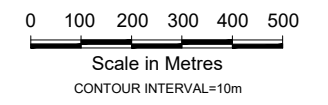

P:\Projects\01_SITES\SSA_Dena_Hes\1CT008_073_fig_01 - Vicinity Mapping

		2020 Dam Safety Inspection		
		Vicinity Map		
SRK JOB NO.: 1CT008.073 FILE NAME: 1CT008_073_fig_01 - Vicinity Map.dwg	Sā Dena Hes Project	DATE: August 2020	APPROVED: PH	FIGURE: 1

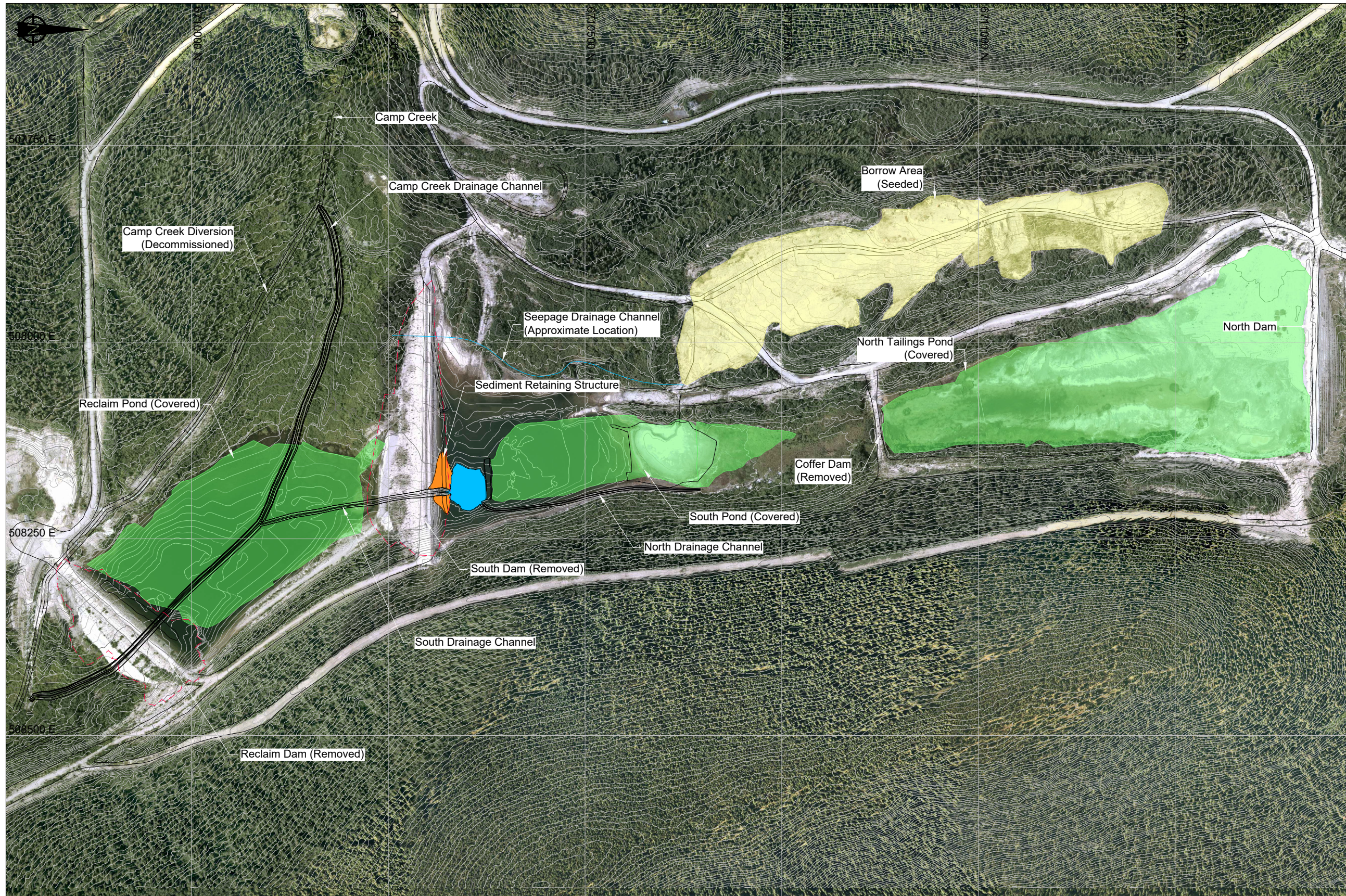

LEGEND

- Major Contour (5m interval)
- Minor Contour (1m interval)
- Edge of Road
- Design Edge of Road
- Camp Creek Drainage Channel
- Dam Excavation Extent
- Sedimentation Pond
- Capped Areas
- Seeded Area

- NOTES**
1. Preconstruction topographical contour data was obtained from McElhanney and is based on August 15, 2012 LiDAR Survey.
 2. As-built survey data was collected by Yukon Engineering Services and Amec Foster Wheeler.
 3. Coordinate system is UTM NAD 83 CSRS Zone 9V.
 4. Tailings characterization work conducted by Golder and Associates determined the location of capping at the South Pond and Reclaim Pond areas.

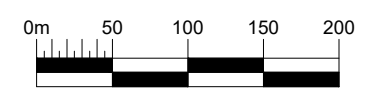

P:\Projects\01_SITES\SSA_Dena_Hes\1CT008_073_2020_DS\1CT008_073_fig_02_General Arrangement.dwg

			2020 Dam Safety Inspection		
	Sä Dena Hes Project		TMA General Arrangement Map		
SRK JOB NO.: 1CT008.073 FILE NAME: 1CT008_073_fig_02 - General Arrangement.dwg			DATE: August 2020	APPROVED: PMH	FIGURE: 2

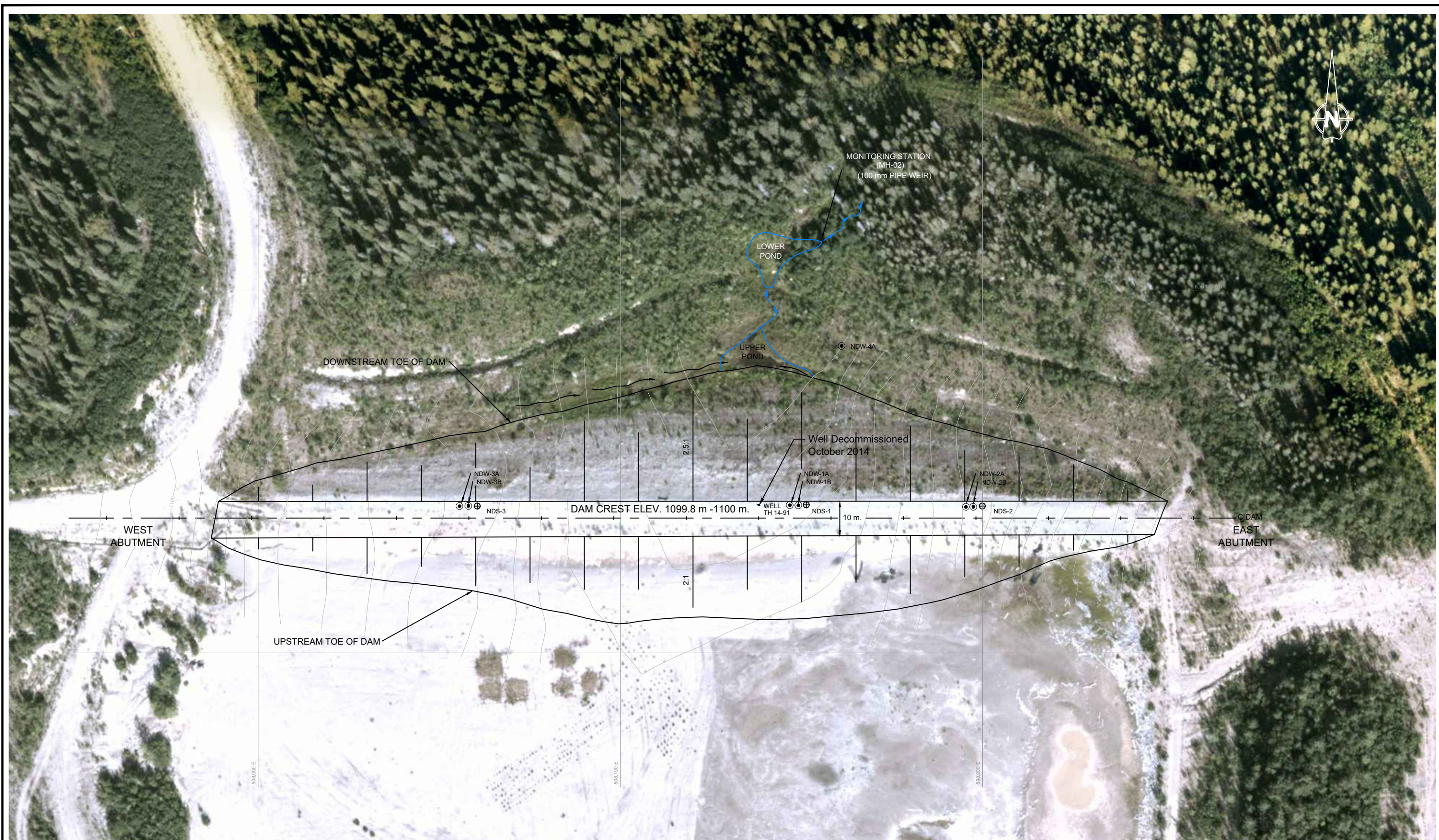

KEY

- NDW-1 PIEZOMETERS INSTALLED (NOV., 1991)
- NDS-1 SETTLEMENT GAUGE INSTALLED (NOV., 1991)
- SEEPAGE

NOTES:

1. Topographic contour data and aerial photos were obtained from McElhanney and are based on August 15, 2012 LiDAR survey and October 2013 YES Survey. Coordinate system is UTM NAD 83CSRS zone 9V.



2020 Dam Safety Inspection

North Dam
Site Plan

SRK JOB NO.: 1CT008.073
FILE NAME: 1CT008_073_fig_03 - North Dam-plan.dwg

Sa Dena Hes Project

DATE: August 2020	APPROVED: P.M.H.	FIGURE: 3
----------------------	---------------------	--------------

P:\Projects\01_SITES\Sa_Dena_Hes\1CT008.073_2020_DSR\1CT008_073_fig_03_North Dam-plan.dwg

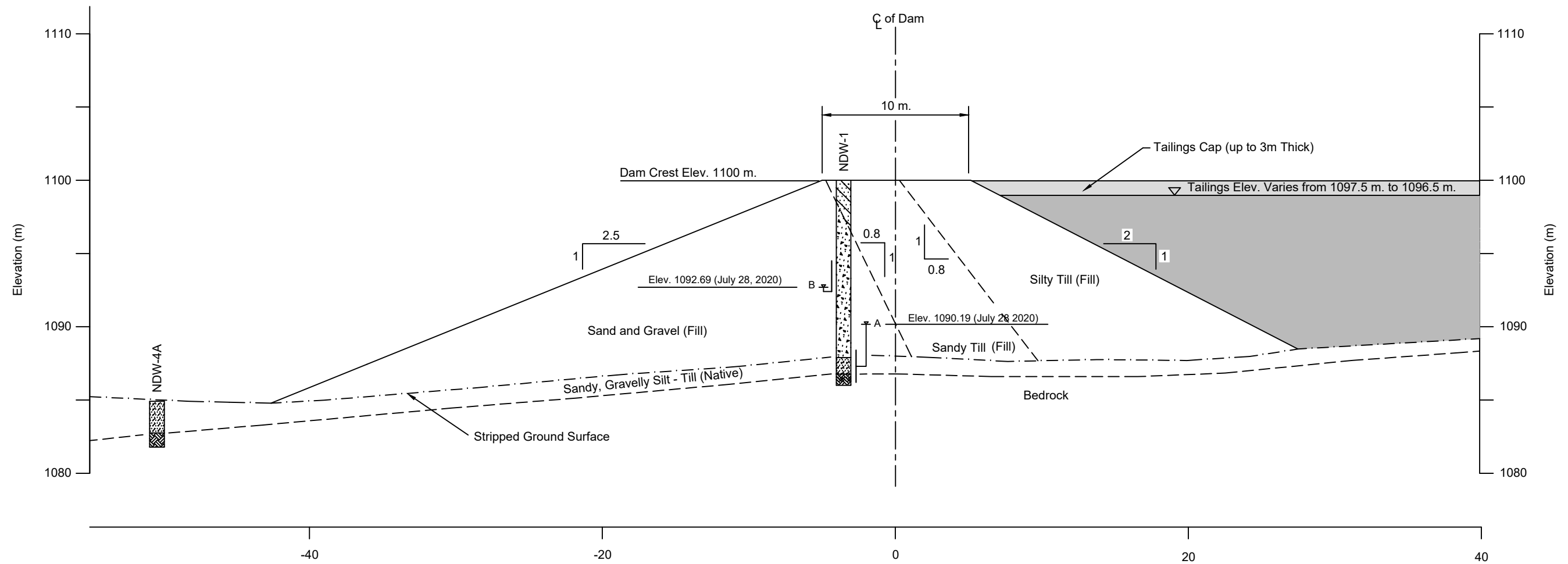

Date	Piezometer	Borehole depth 1990 (mBTOC)	Piezometer Interval 1990 (mBTOC)	Soil Type	Top of Casing Elev. (mamsl)	Ground Elevation (mamsl)	Water Reading (mBTOC)	Top of water (mamsl)	Depth to Bottom (2020) (mBTOC)	Bottom of hole (mamsl)	Piezometer Interval (mamsl)
28-Jul-20	NDW-1A	14.44	12.34-14.44	Bedrock	1100.74	1100.00	10.55	1090.19	14.44	1086.30	1086.3-1088.4
28-Jul-20	NDW-1B	8.30	6.2-8.3	Sandy Till	1100.70	1100.00	8.01	1092.69	8.03	1092.67	1092.4-1094.5

LEGEND

	Sandy Till (Fill)		Gravelly Silty Sand (Till)		Tailings
	Silty Till (Fill)		Sand & Gravel (Native)		Tailings Cap
	Sand & Gravel(Fill)		Bedrock		
	Silty Sand (Till)		Piezometric Head for Filter Zone Indicated		



NOTES

- Topographic contour data and aerial photos were obtained from McElhanney and are based on August 15, 2012 LiDAR survey. Coordinate system is UTM NAD 83CSRS zone 9V.

		2020 Dam Safety Inspection	
		North Dam Section 0+400	
SRK JOB NO.: 1CT008.073	Sä Dena Hes Project	DATE: August 2020	APPROVED: PMH
FILE NAME: 1CT008_073_fig_04 - North Dam-XS.dwg		FIGURE: 4	

P:\Projects\01_SITES\01a_Dena_Hes\1CT008_073_2020\DSI\1CT008_073_fig_04 - North Dam-XS.dwg

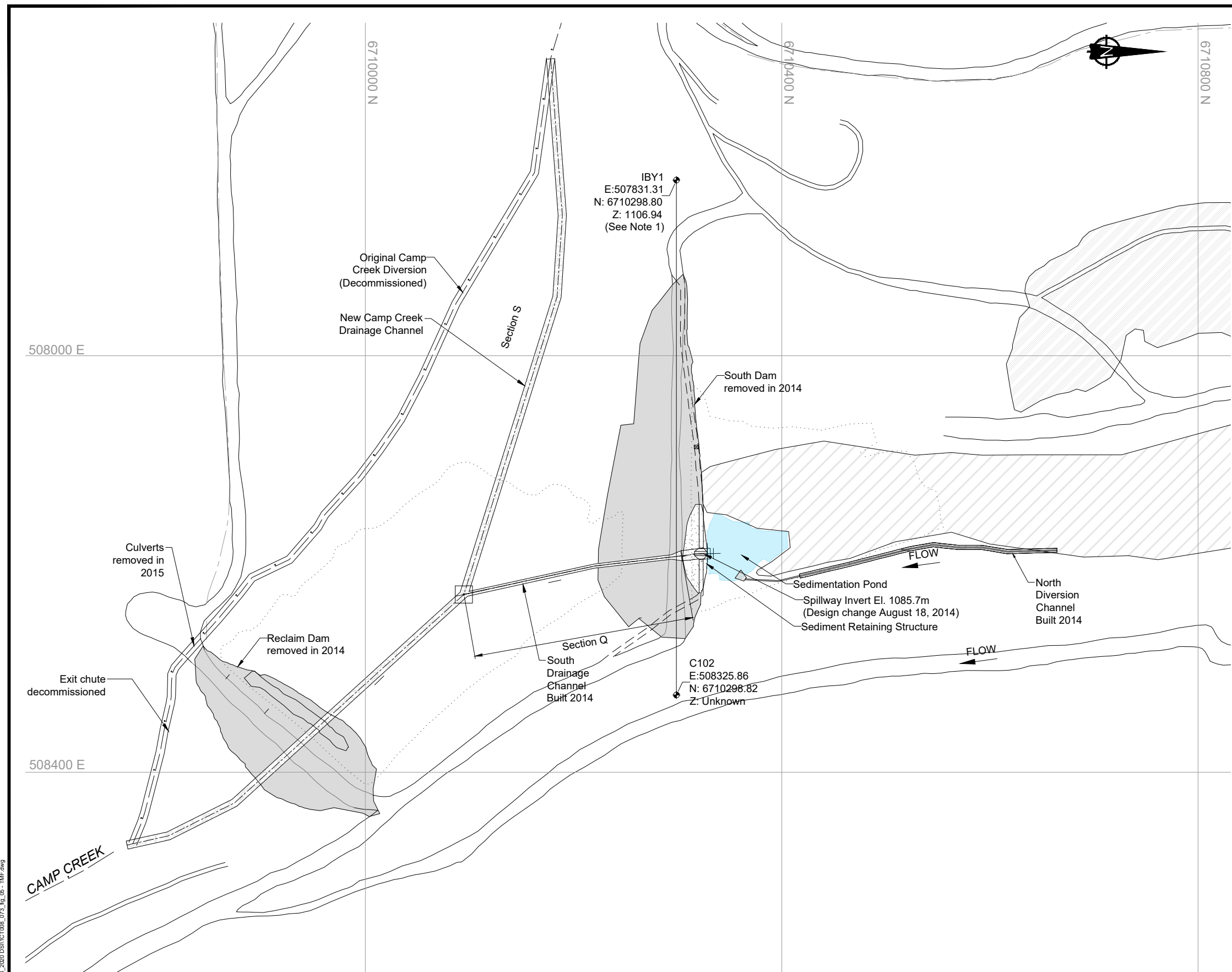

LEGEND

- Covered Tailings
- Removed Dams
- Sedimentation Pond
- Minor Contours (1m interval)
- Major Contours (5m interval)
- Camp Creek
- Drainage Channel

NOTES

- This Benchmark datum is currently used to monitor settlement gauges on the dam and was used as the benchmark in construction of the dam. The elevation has been adjusted from 1103.54m to the current LiDAR Survey elevation.

P:\Projects\01_SITES\SSA_Dena_Hes\1CT008_073_2020_DS\1CT008_073_fig_05_TMF.dwg

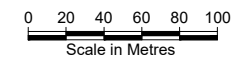

		2020 Dam Safety Inspection		
		Sediment Retaining Structure Location Map		
SRK JOB NO.: 1CT008.073	Sä Dena Hes Project	DATE:	APPROVED:	FIGURE:
FILE NAME: 1CT008_073_fig_05 - TMF.dwg		August 2020	PMH	5

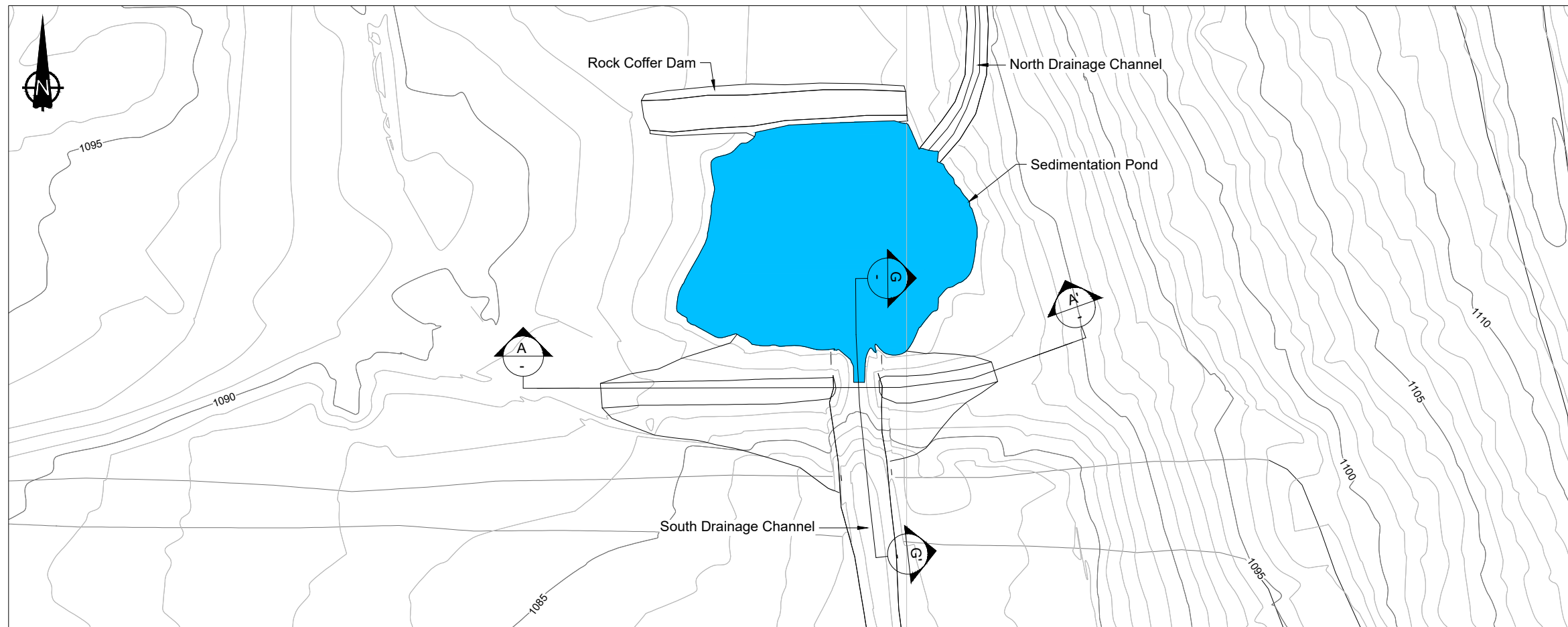

- LEGEND**
- Major Contour (5m)
 - Minor Contour (1m)
 - Dam Crest
 - Dam Toe
 - - - Edge of Road
 - Sediment Pond
- PROFILE AND DETAIL LEGEND**
- Original Ground
 - - - Non-woven Geotextile
 - ▨ Riprap

- NOTES**
1. Excavated dam fill material was used to cap tailings. The final excavated surface was graded to promote drainage and blended topography into adjacent natural topography.
 2. Rip rap from downstream toe buttress was salvaged and reused during channel construction.
 3. The decant tower was demolished down to the foundation. Steel reinforced concrete was deposited in the onsite landfill located in Borrow Area C. The remaining concrete foundation was covered with dam fill material and graded to blend into topography.
 4. Design extents of rip rap and geotextile, as no as-built survey.

Plan

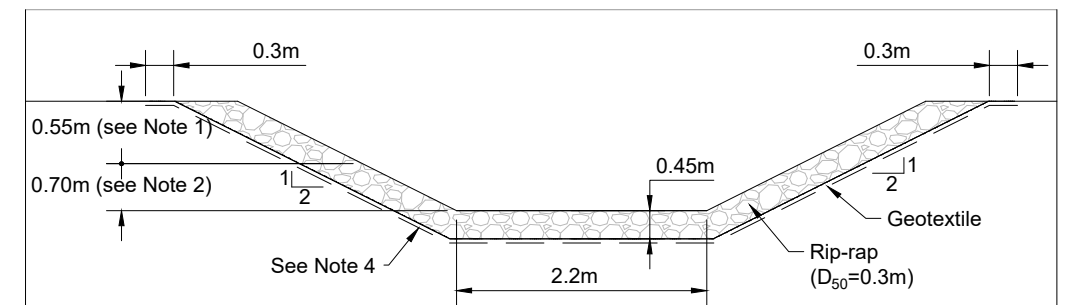
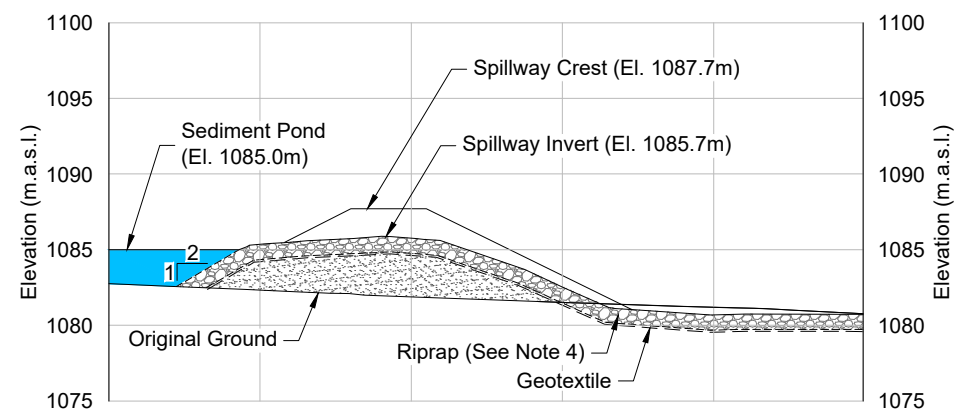
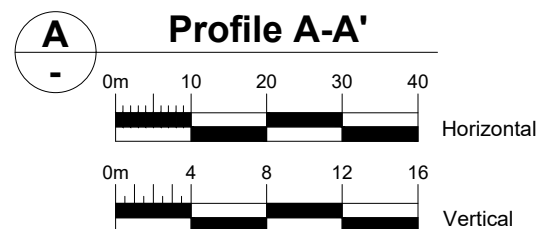
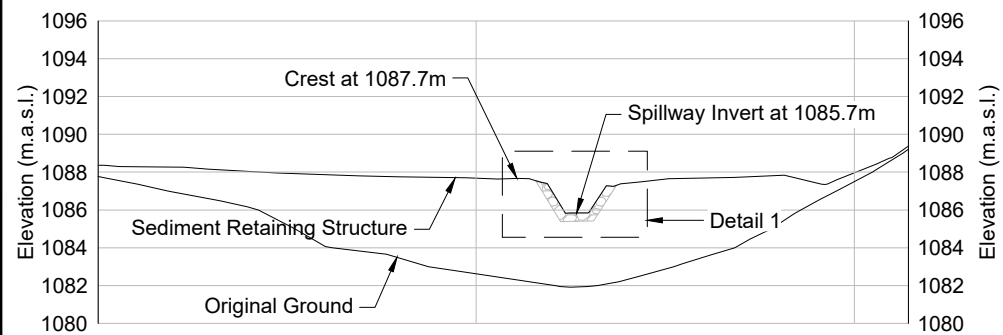
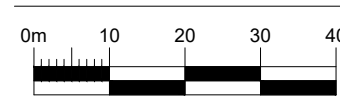

1

Detail 1 - Design Spillway Typical Section

N.T.S.

srk consulting

Teck

2020 Dam Safety Investigation

Sediment Retaining Structure
Plan and Profile

SRK JOB NO.: 1CT008.073
FILE NAME: 1CT008_073_fig_06 - Sediment Retaining Struct.dwg

Sä Dena Hes Project

DATE: August 2020
APPROVED: PMH
DRAWING: 6

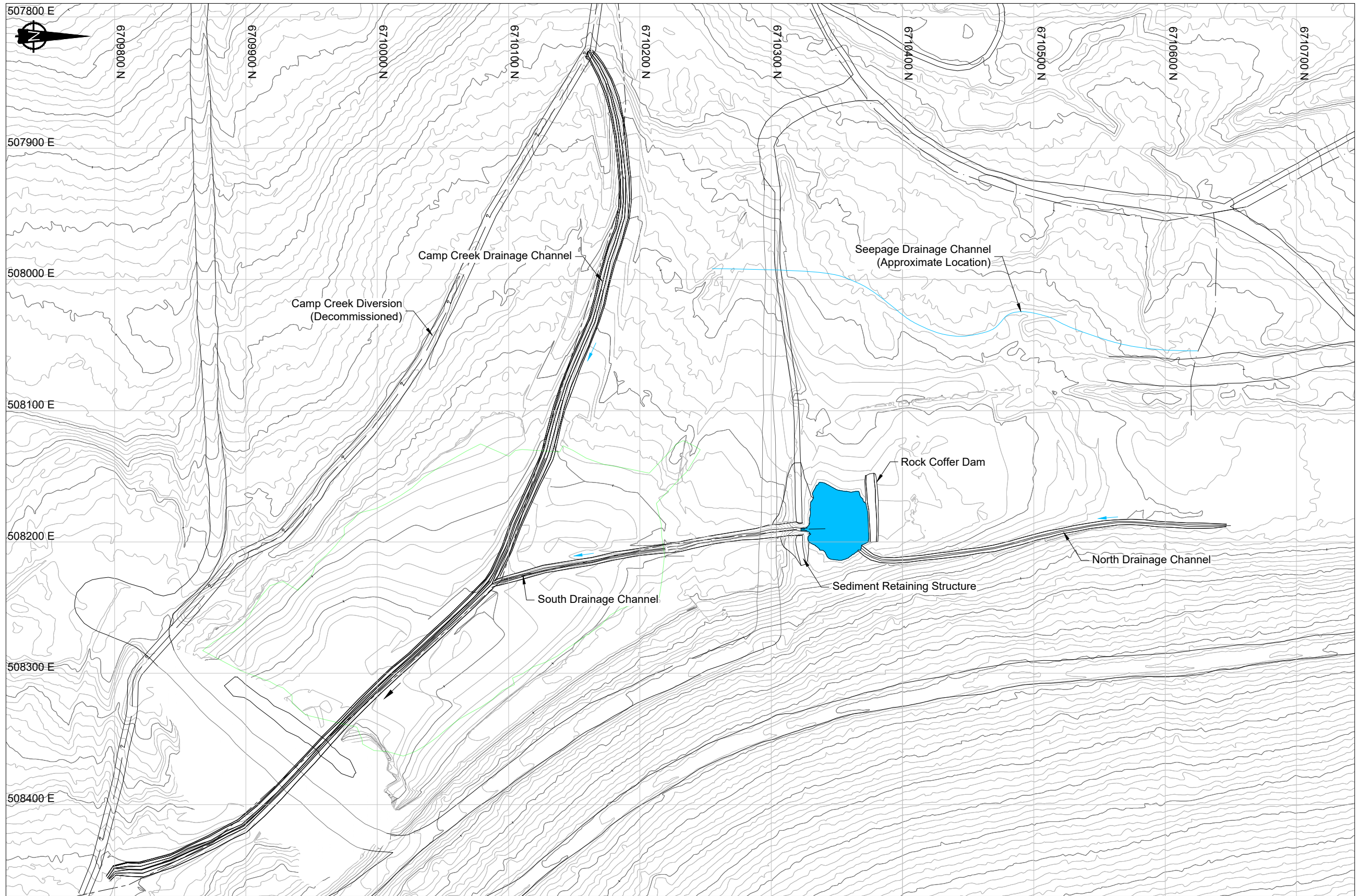

LEGEND

- Major Contour (5m)
- Minor Contour (1m)
- Dam Crest
- Dam Toe
- Edge of Road
- Direction of Flow
- Sediment Pond

NOTES

1. As-built Camp Creek Drainage Channel upstream and downstream tie-in locations and North Drainage Channel alignments were modified from the design by Amec foster wheeler, with consultation from SRK and Teck, based on field conditions.

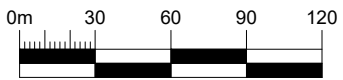

P:\Projects\01_SITES\SSA_Dena_Hes\1CT008_073_4a_07 - Drainage Channel.dwg

			2020 Dam Safety Investigation		
	Sä Dena Hes Project		Drainage Channel Plan		
SRK JOB NO.: 1CT008.073 FILE NAME: 1CT008_073_fig_07 - Drainage Channel.dwg			DATE: August 2020	APPROVED: PMH	DRAWING: 7

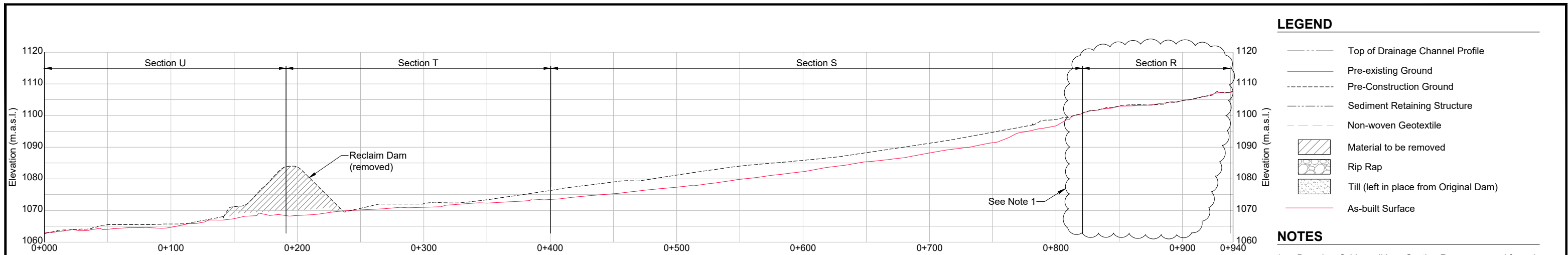

- LEGEND**
- Top of Drainage Channel Profile
 - Pre-existing Ground
 - - - Pre-Construction Ground
 - - - Sediment Retaining Structure
 - - - Non-woven Geotextile
 - ▨ Material to be removed
 - ▩ Rip Rap
 - ▧ Till (left in place from Original Dam)
 - As-built Surface

- NOTES**
- Based on field conditions Section R was removed from the design and the upstream tie-in location was modified.
 - Design extents of rip rap and geotextile, as no as-built survey.

W 09 Profile W - W'
Camp Creek Channel
 Horizontal: 0 10 20 30 40 50
 Scale in Metres
 Vertical: 0 5 10 15 20 25
 Scale in Metres

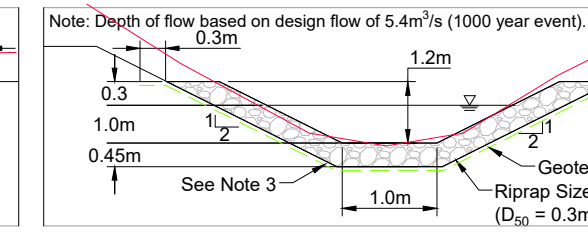
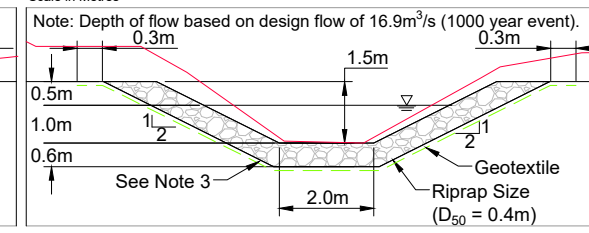
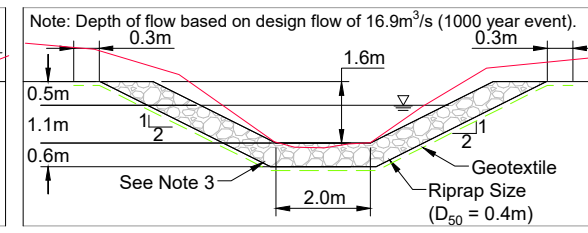
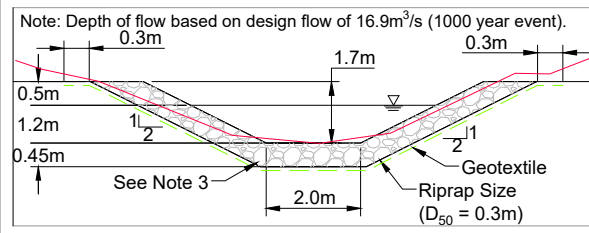

U 09 DESIGN SECTION U - U'
Camp Creek Drainage Channel
 N.T.S.

T 09 DESIGN SECTION T - T'
Camp Creek Drainage Channel
 N.T.S.

S 09 DESIGN SECTION S - S'
Camp Creek Drainage Channel
 N.T.S.

Q 09 DESIGN SECTION Q - Q'
South Drainage Channel
 N.T.S.

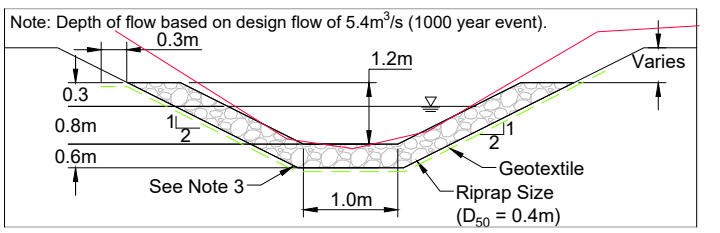

P 09 DESIGN SECTION P - P'
South Dam Drainage Channel
 N.T.S.

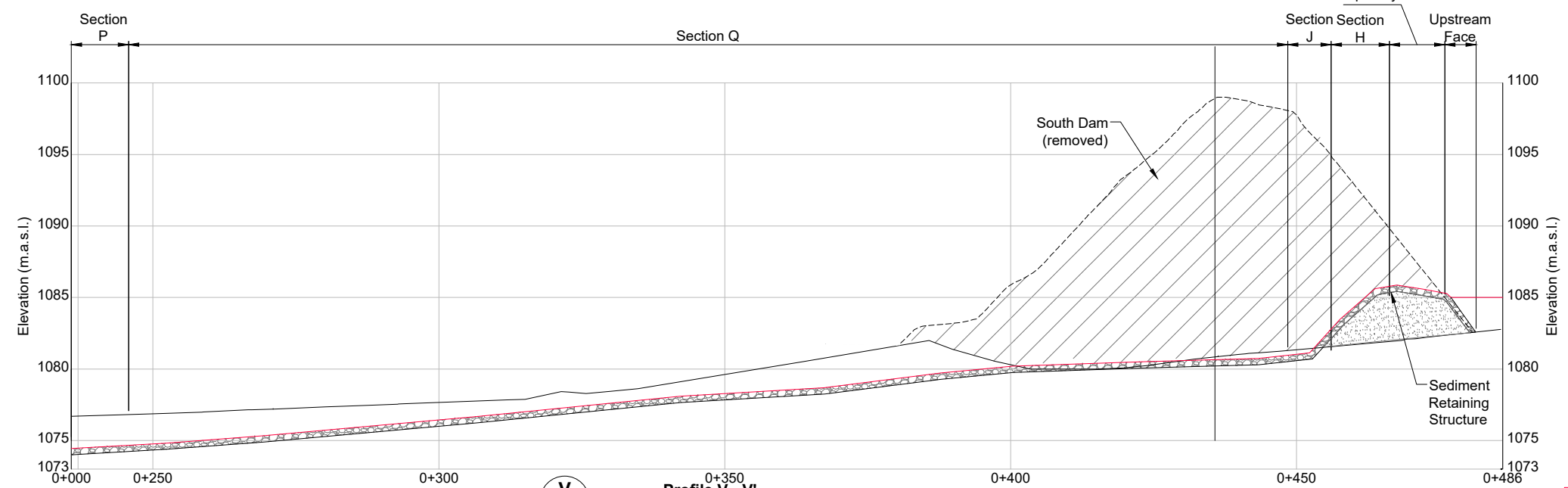

V 09 Profile V - V'
South Drainage Channel
 Horizontal: 0 5 10 15 20 25
 Scale in Metres
 Vertical: 0 2 4 6 8 10
 Scale in Metres

Design Drainage Channel Riprap Volume Summary Table			
Location	D ₅₀ (m)	Armoring Depth (m)	Volume (m ³)
Section U	0.3	0.45	993
Section T	0.4	0.6	1409
Section S	0.4	0.6	2875
Section P	0.4	0.6	52

AS-BUILT EXCAVATED RIPRAP QUANTITIES USED FOR CHANNEL CONSTRUCTION			
Material	Units	Quantity	Notes
Riprap developed from the Quarry	m ³	5,492	Volume tracked by Amec Foster Wheeler
Riprap salvaged from Toe Buttresses	m ³	3,592	Volume tracked by Amec Foster Wheeler

P:\Project\01_SITES\01_Dams_Hes\1CT008_073_2020_DSM\1CT008_073_fig_08-09-AB_Asbuilt.dwg

SRK JOB NO: 1CT008.073
 FILE NAME: 1CT008_073_fig_08-09-AB_Asbuilt.dwg

Sā Dena Hes Project

2020 Dam Safety Inspection

DRAWING TITLE:
Drainage Channel Sections

DATE: August 2020 APPROVED: PMH FIGURE NO. **8**



PLAN
 0 5 10 15 20 25
 Scale in Metres

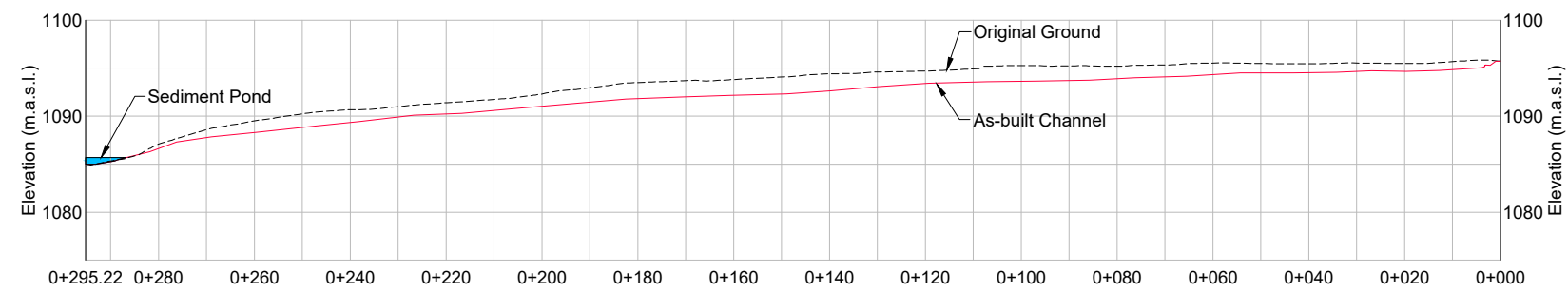

Profile ND - ND'
 2x Vertical Exaggeration
 Horizontal: 0 5 10 15 20 25
 Scale in Metres
 Vertical: 0 2.5 5 7.5 10 12.5
 Scale in Metres

NOTES

1. Based on field conditions the North Drainage Channel was realigned to avoid constructing the channel through deposited tailings.
2. Based on field conditions a Rock Cofferdam was constructed to retain soft tailings from sliding into the sediment retention pond during cover construction.
3. The decant tower was demolished down to the foundation. Steel reinforced concrete was deposited in the onsite landfill located in Borrow Area C. The remaining concrete foundation was covered with dam fill material and graded to blend into topography.
4. Design extents of rip rap and geotextile, as no as-built survey.

LEGEND

- Major Contours (5m)
- Minor Contours (1m)
- Edge of Road
- Tailings Pipeline
- Existing Ground (Profile)
- Non-woven Geotextile
- Covered Tailings (Proposed in Design)
- Rip Rap
- Sediment Pond (As-built)
- As-built Toe
- As-built Crest
- As-built Extent of Excavation / Fill

Design North Tailings Drainage Channel Riprap Volume Summary Table:

Location	D ₅₀ (m)	Armoring Depth (m)	Volume (m ³)
Y	0.3	0.45	638
Discharge Area	0.3	0.45	25

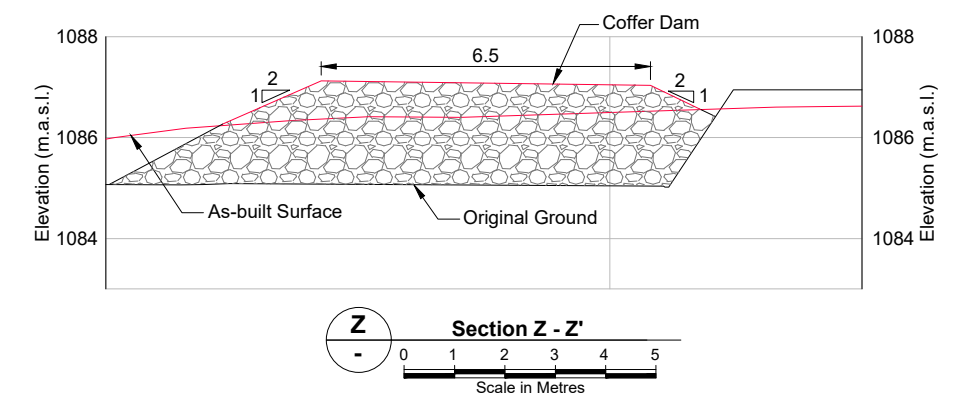

Section Z - Z'
 0 1 2 3 4 5
 Scale in Metres

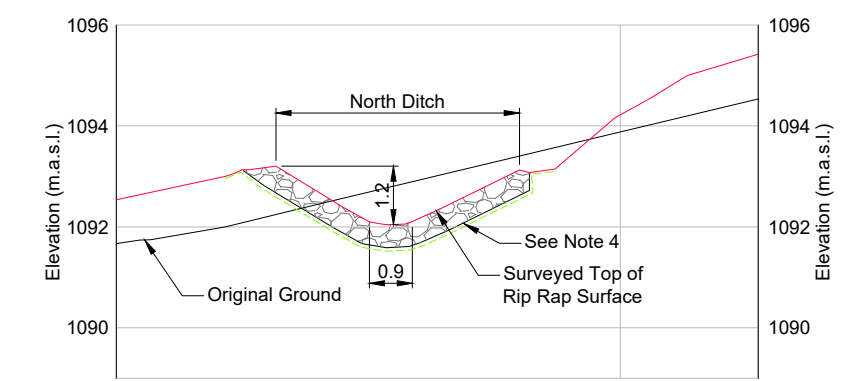

Section Y - Y'
 0 1 2 3 4 5
 Scale in Metres

P:\Project\01_SITES\01a_Dena_Hes\1CT008_073_2020_DS\1CT008_073_fig_08-09-AB_Asbuilt.dwg

		2020 Dam Safety Inspection		
		DRAWING TITLE: North Drainage Channel Plan, Profile and Section		
SRK JOB NO: 1CT008.073 FILE NAME: 1CT008_073_fig_08-09-AB_Asbuilt.dwg	Sä Dena Hes Project	DATE: August 2020	APPROVED: PMH	FIGURE NO. 9

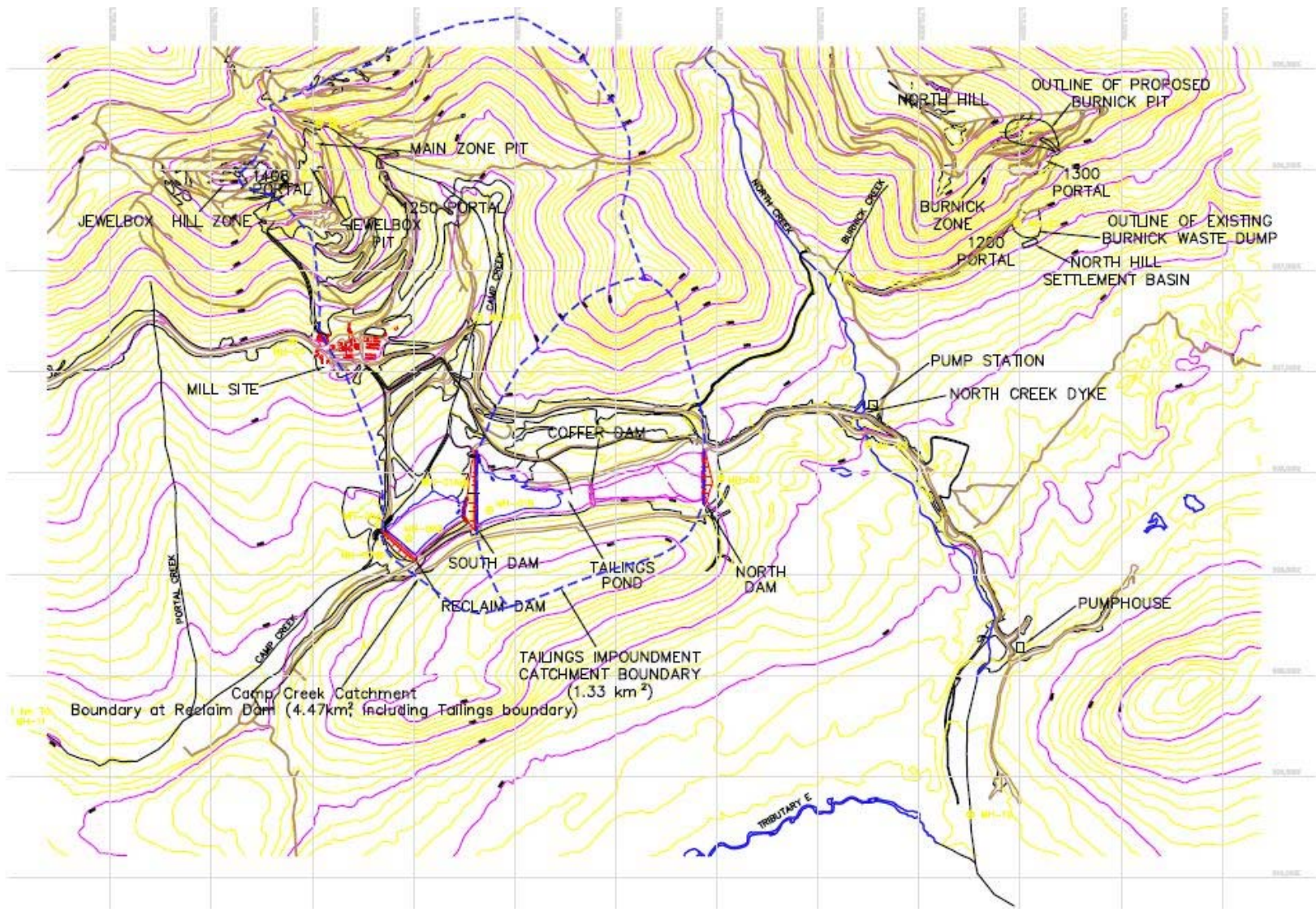

2020 Dam Safety Inspection

Catchment Areas

Job No: 1CT008.073
 Filename: 1CT008_073_fig_10 - CatchmentMap.pptx

Sä Dena Hes Project

Date:
August 2020

Approved:
PH

Figure: **10**

\\warsprd01.van.na.srk.adf01_SITES\Sa_Dena_Hes\1CT008_053_2015_Geotechnical_Inspection\040_AutoCAD\Footerpoint\Figures

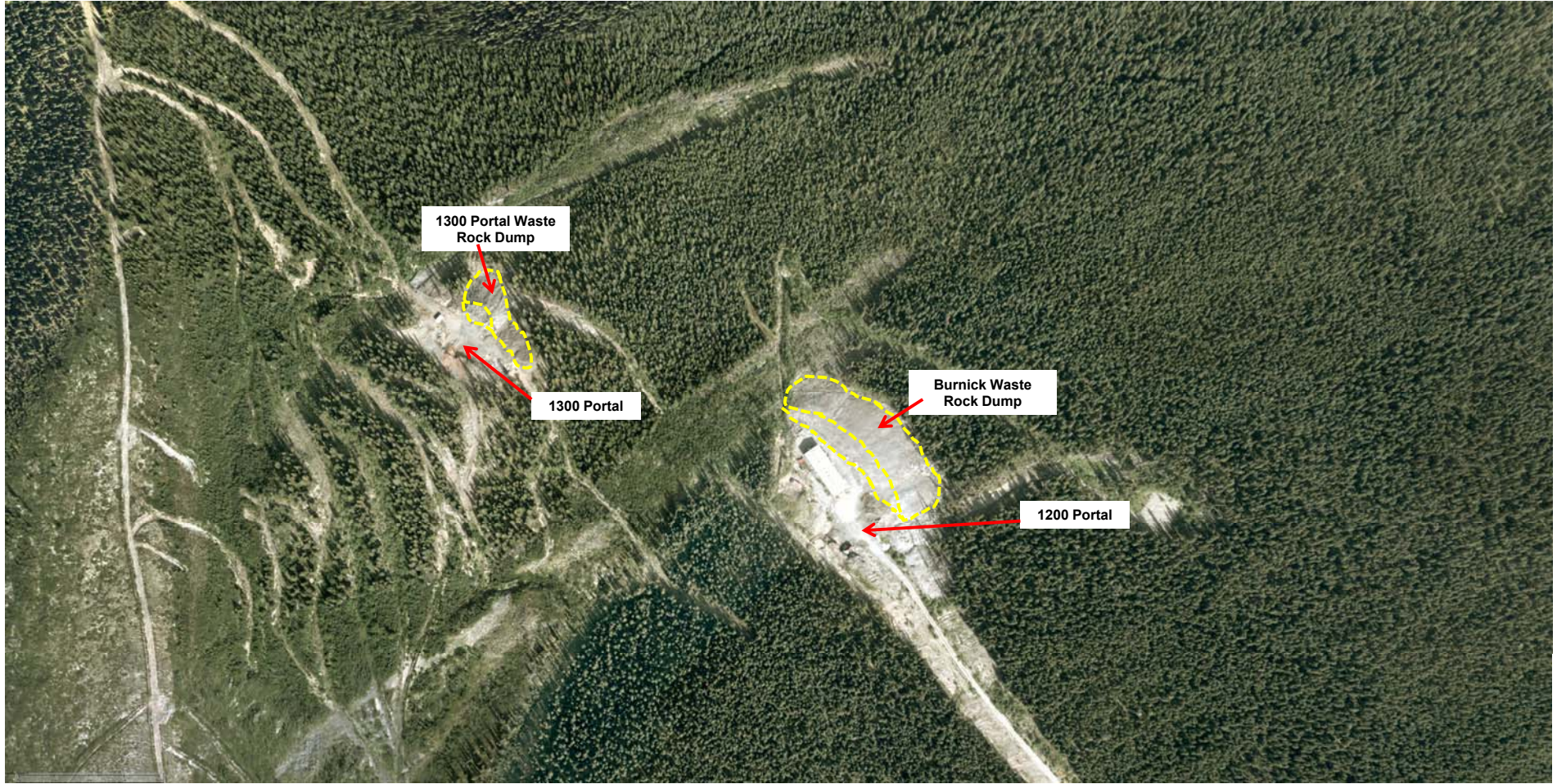

Teck

2020 Dam Safety Inspection

Burnick Zone Plan View

Job No: 1CT008.073
Filename: 1CT008_073_fig_11 - Burnick Zone.pptx

Sä Dena Hes

Date: August 2020	Approved: PMH	Figure: 11
----------------------	------------------	----------------------

\\wan-srv01.van.na.srk.ad\01_SITES\Sa_Dena_Hes\1CT008_053_2015 Geotechnical Investigation\040_AutoCAD\Powerpoint Figures

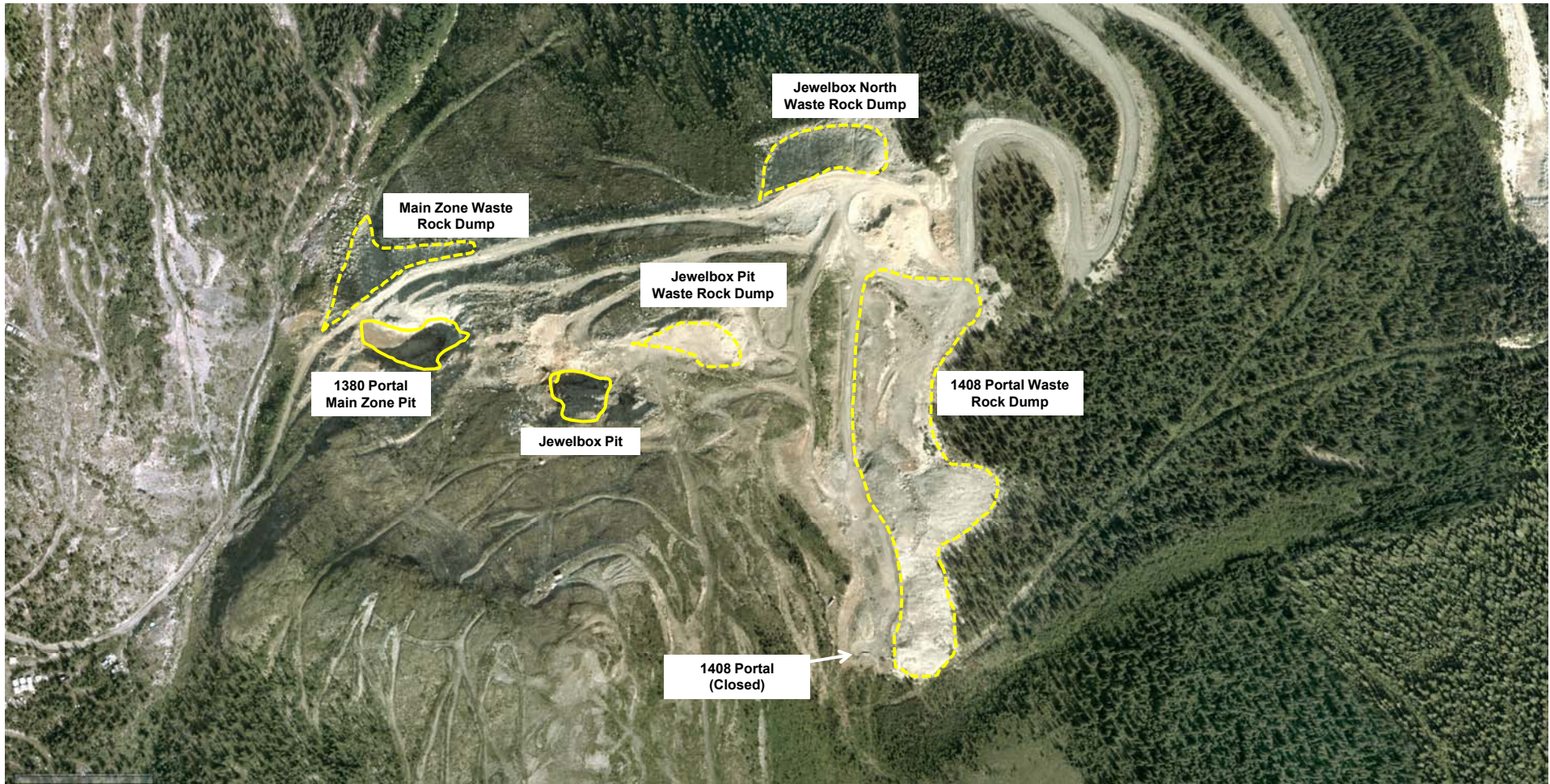

		2020 Dam Safety Inspection		
		Main Zone and Jewelbox Zone Plan View		
Job No: 1CT008.073 Filename: 1CT008_073_fig_12 - Main Zone and JB Zone.pptx	Sä Dena Hes	Date: August 2020	Approved: PMH	Figure: 12

Appendix A – Photos



Photo 1 View West of the North Dam



Photo 2 View east over the downstream face of the North Dam



Photo 3 Piezometer NDW 3A protective cap



Photo 4 Piezometer NDW 3A PVC Standpipe with red cap



Photo 5 Displacement pins (redundant)



Photo 6 MH02 Flow Monitoring Pipe



Photo 7 View west of the SRS crest. Note vegetation and geogrid for stabilization



Photo 8 Downstream slope of SRS with shallow erosion rill



Photo 9 View south of the South Drainage Channel



Photo 10 Subsidence in the berm adjacent to the North Drainage Channel



Photo 11 View of the North Drainage channel subsidence



Photo 12 North Drainage Channel subsidence



Photo 13 Subsidence in the channel slope at the North Creek second crossing



Photo 14: Small sink hole in the landfill south of the North Dam



Photo 15 Tension crack in fill at the Burnick Waste Rock Dump



Photo 16: Downstream slope of the Burnick Waste Rock dump



Photo 17 Jewelbox Waste Rock dump



Photo 18 Erosion gully at base of Jewelbox waste rock dump



Photo 19 View north with the TMA in the background



Photo 20 Backfill at the 1380 Portal below Main Zone Waste Rock dump



Photo 21: Openings in pit wall above Main Zone Waste Rock Dump



Photo 22 View looking north over the headwater of Camp Creek

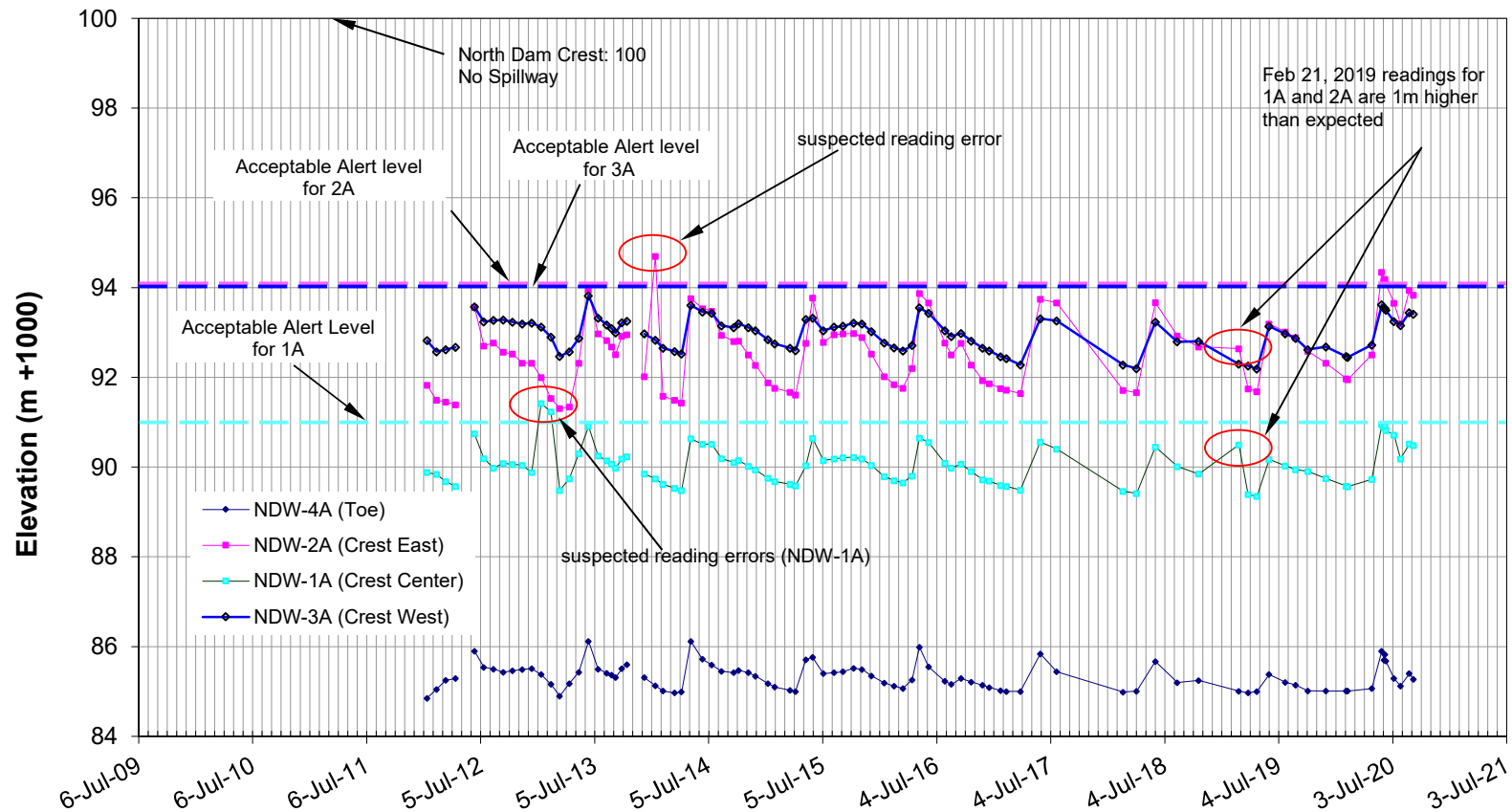

\\van-svr01\Projects\01_SITES\Sa_Dena_Hes\1CT008.072_2019_Dam Safety Inspection\



2020 Dam Safety Inspection

North Dam Piezometric Levels vs. Time

Job No: 1CT008.073

File: NDMPiezolevels_1CT008.073_PMH_20200916

Sa Dena Hes Mine

Date:
September 2020

Approved:
PMH

Figure:

B1

Appendix C – Facility Data Sheets

Appendix C
Facility Data Sheet

North Dam and SRS Dyke
Physical Description

North Dam	
Dam Type	Earth Dam, Single Stage, three zones
Maximum Dam Height	15m
Dam Crest Width	10m
Impoundment Area	0.16 km ²
Volume of Tailings	400,000 m ³
Reservoir Capacity	NA
Consequence Classification	Significant, Passive care
Inflow Design Flood (IDF)	1/3 between the 1,000-year event and the PMF
Design Earthquake	1: 2475- year event
Spillway Capacity	NA
Catchment Area	NA till cover slopes (drains) to south towards SRS
Access to Dam	Vehicles via roads or helicopter in winter
SRS Dyke	
Dam Type	Earth Dam, Single Stage, one zone
Maximum Dam Height	5m
Dam Crest Width	4m
Impoundment Area	Pond area is 1600m ²
Volume of Tailings	400,000 m ³
Reservoir Capacity	800 m ³
Consequence Classification	Low, Passive care
Inflow Design Flood (IDF)	1,000-year event
Design Earthquake	1,000-year event
Spillway Capacity	5.4m ³ /s
Catchment Area	1.33 sq km
Access to Dam	Vehicles via roads or helicopter in winter

Appendix D – Background Information and History

Background Information and History

The original TMA, which extended from the North Dam to the South Dam covered an area of approximately 0.205 sq. km (Figure 2). During the operating life of the mine, approximately 700,000 tonnes of tailings were deposited into the impoundment, primarily at the northern end. The North and South dams, which impounded the tailings, were constructed between July 1990 and October 1991. The starter dams for both structures were built to a height of about 13 metres. Between the two dams, at the location of a topographic saddle, was a 2 m high cofferdam, which had a gated culvert to control the flow of water and tailings from the northern half of the impoundment to the southern half.

In addition to the North and South Dams, a Reclaim Dam was built to detain supernatant water. A decant tower, in the South Tailings Pond, was used to discharge the supernatant water in the tailings pond into the Reclaim Pond through a 0.5 m diameter corrugated steel decant pipe (CSP). The mine operation involved recycling of the detained water to the mill with a controlled discharge, when required, into the adjacent Camp Creek from April to October each year.

An open channel emergency spillway was located at the west side of the Reclaim Pond. This spillway was designed to accommodate the design flood event from the TMA catchment only. Flow through this spillway was directed to the primary spillway system, which was part of the Camp Creek diversion channel constructed along the west side of the Reclaim Pond. This primary spillway consisted of two 1,200 mm diameter CSP culverts and was designed to accommodate the 1 in 200-year Inflow Design Flood (IDF). Camp Creek was diverted into the diversion channel and discharged through the two culverts into a riprap lined exit chute.

An emergency spillway was also located in the west abutment of the South Dam and was designed to accommodate the 200-year IDF. The spillway consisted of two 900 mm diameter CSP culverts. The discharge from the spillway entered the Reclaim Pond downstream via an unlined channel.

Two additional surface water diversions, the east and west interceptor ditches, were located on both sides of the TMA to intercept surface runoff from upslope of the TMA.

In March of 1992, the previous operators, Curragh Resources, built a rockfill buttress along the toe of the Reclaim dam to provide extra protection against sloughing and erosion of the toe due to seepage.

In September 1992, work commenced on a 2-metre raise of the South Dam to El. 1098. Work on the extension was shut down on October 14, 1992 because of construction difficulties experienced due to sub-zero temperatures.

Operations at Să Dena Hes mine, which commenced in July 1991, were suspended in December 1992 due to low lead and zinc prices.

During the care and maintenance period after the mine shut down in 1992, water was released from the tailings pond to the Reclaim Pond seasonally by way of syphons to maintain a safe

operating level. Water was discharged from the Reclaim Pond to Camp Creek in accordance with the limits imposed by the Water License.

The Să Dena Hes Operating Corporation (SDHOC) purchased the property from Curragh Resources Inc. in March 1994. The Să Dena Hes Mining Corporation (the Company) is a joint venture between Teck Resources Limited (“Teck” - 50% ownership) and Pan Pacific Metal Mining Corp (50% ownership, a wholly owned subsidiary of Korea Zinc.) Teck is the operator and manages the property under the joint venture agreement.

In 2003, Teck installed an HDPE pipeline through one of the spillway culverts as a siphon to facilitate the transfer of water from the South Tailings Pond.

With the 2014 decommissioning work, the TMA was significantly modified. The Reclaim Dam was completely removed, and the final excavated surface of the Reclaim Dam was graded to blend into the surrounded topography.

In 2014, most of the South Dam was removed to form the Sediment Retaining Structure (SRS). The decant tower and the pipe were decommissioned and removed to the on-site landfill. The South Dam overflow spillway was decommissioned by removing the two 900 mm diameter culverts that were disposed of at the landfill. Similarly, to the decommissioning of the Reclaim Dam, the dam footprint was excavated to original ground (with exception of the SRS) and blended into the surrounded topography.

The Camp Creek Diversion Channel, exit chute, and culverts were decommissioned in 2015. The interceptor ditches were decommissioned in 2015.

Many of the access roads at the site have been decommissioned and access to the decommissioned Main Zone, Jewelbox and Burnick areas are via all-terrain vehicle or helicopter.

After the 1992 shutdown of the mine, it never reopened, and no more tailings were deposited into the TMA. Information on the decommissioning of the mine is provided in Section 1.4.

Teck conducts on-going maintenance and surveillance of the TMA and the water management infrastructure at the site including the access road from the Robert Campbell Highway. Any trees or vegetation on the downstream slope of North Dam that do not conform to the guidelines in the Să Dena Hes OMS manual are trimmed or removed. Seepage at the toe of the North Dam is monitored monthly with sampling of water quality and measurement of flow. During the monthly inspections by the sampling team, an inspection of the North Dam and the SRS spillway is made to check for any blockages or subsidence.