



RST INSTRUMENTS LTD.

Borehole Packers Instruction Manual

RST Instruments Ltd.
200 – 2050 Hartley Avenue
Coquitlam, B.C. Canada V3K 6W5
Tel: (604) 540-1100
Fax: (604) 540-1005
e-mail: info@rstinstruments.com

INSTRUCTIONS FOR ASSEMBLY AND USE OF 'RST' BOREHOLE PACKERS

Although all efforts have been made to ensure the accuracy and completeness of the information contained in this document, RST Instruments reserves the right to change the information at any time and assumes no liability for its accuracy.

Product: Borehole Packers
Installation Manual

Document number: BPM0001D Borehole Packer Instruction Manual-r2.0.doc
Revision: 2.0
Date: June 29, 2004

Table of Contents

1	GENERAL DESCRIPTION	1
2	METHOD OF ASSEMBLY	1
3	LOWERING & INFLATING THE PACKERS	7
4	DEFLATING THE PACKERS.....	7
5	DETERMINING PRESSURE NEEDED TO INFLATE PACKERS.....	7
6	REVIEW	8
7	SAFETY	8
8	CHANGING THE PACKER GLAND.....	9
9	TROUBLE SHOOTING.....	9

List of Figures

Figure 1: Wireline Triple Packer Setup.....	2
Figure 2: Wireline Double Packer Setup	3
Figure 3: Double Shafted Packer	4
Figure 4: Sampling Pump Setup	5
Figure 5: Pressure Sensor Setup	6
Figure 6: Packer Test Setup.....	10
Figure 7: M30 Packer Inflation Curve.....	11
Figure 8: M45 Packer Inflation Curve.....	12
Figure 9: M55 Packer Inflation Curve.....	13
Figure 10: M75 Packer Inflation Curve	14
Figure 11: M85 Packer Inflation Curve	15
Figure 12: M120 Packer Inflation Curve.....	16
Figure 13: M145 Packer Inflation Curve.....	17
Figure 14: M200 Packer Inflation Curve.....	18
Figure 15: M250 Packer Inflation Curve.....	19
Figure 16: M300 Packer Inflation Curve.....	20
Figure 17: BP1000 Packer Inflation Curve	21
Figure 18: BP1002 Packer Inflation Curve	22
Figure 19: BP1004 Packer Inflation Curve	23
Figure 20: BP1006 Packer Inflation Curve	24
Figure 21: BP1008 Packer Inflation Curve	25

1 GENERAL DESCRIPTION

RST Borehole packers are designed to enable permeability or other packer testing to be performed in open holes and through-the-bit in diamond drill holes, using the drill rods to conduct the test water. Although these instructions below primarily deal with through-the-bit applications, the methodology is the same for open hole applications. To carry out a test, the diamond bit is pulled back from the bottom of the hole by some predetermined amount and the packer assembly is lowered through the rods until the seating cone comes to rest on the drill bit. In this position, the lower packer of the system has passed through the bit and is suspended just below it, while the upper packer remains inside the rods just above the bit. Thus, when the two packers are inflated the lower one packs off the hole and the upper one packs off the rod. The portion of the hole to be tested then becomes the section between the lower packer and the hole bottom. When straddle zone testing, three packers are required. The portion of the hole to be tested is then the section between the middle and lower packer. (see Figure 1: Wireline Triple Packer Setup)

2 METHOD OF ASSEMBLY

It will be noted that each individual packer has one end, which is fixed, and one end which is free to slide along the stainless steel pipe which forms the mandrel of the packer. This sliding end is attached to the packer only by the inflatable gland, and cannot, therefore, transmit torque. On no account should wrenches be applied to the sliding head, or to the central shaft, on which they slide, when assembling or dismantling the system. It should also be noted that the ends of the packers are equipped with 1/8 NPT to 3/16 tube connectors for attaching inflation line.

Since the packers used are identical, it is immaterial which packer is chosen to be the upper, and which to be the middle or lower one. To avoid possible damage when screwing plugs or tube fittings into or out of the air inserts in the sliding heads, always hold the sliding head with a wrench before applying torque to the fitting being screwed in or out. Similarly, when screwing bushings or other fittings on or off the stainless steel shaft which protrudes through the sliding head, always hold the shaft with a wrench or vise-grip to avoid loosening it where it screws into the fixed head of the packer. To avoid damaging the seal, always hold the shaft at the end furthest from the sliding head.

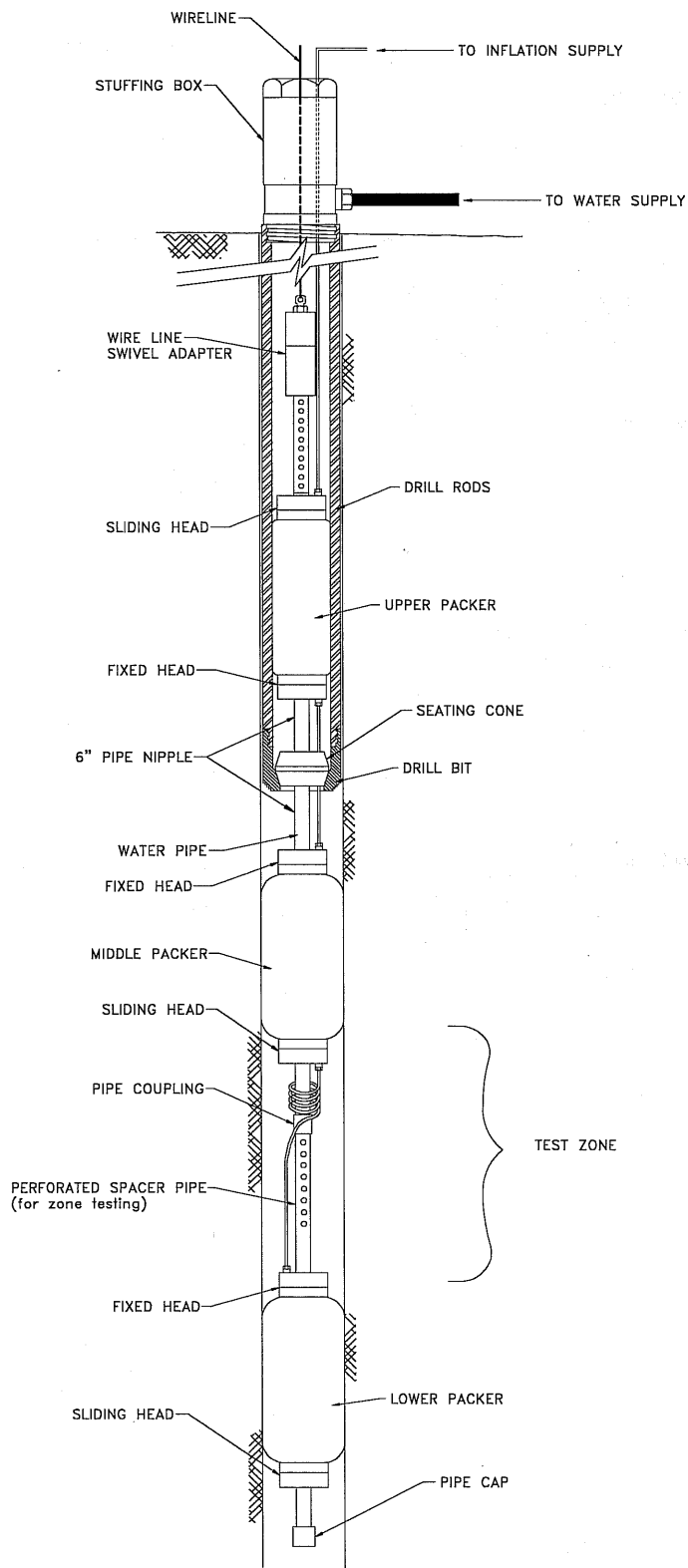

Figure 1: Wireline Triple Packer Setup

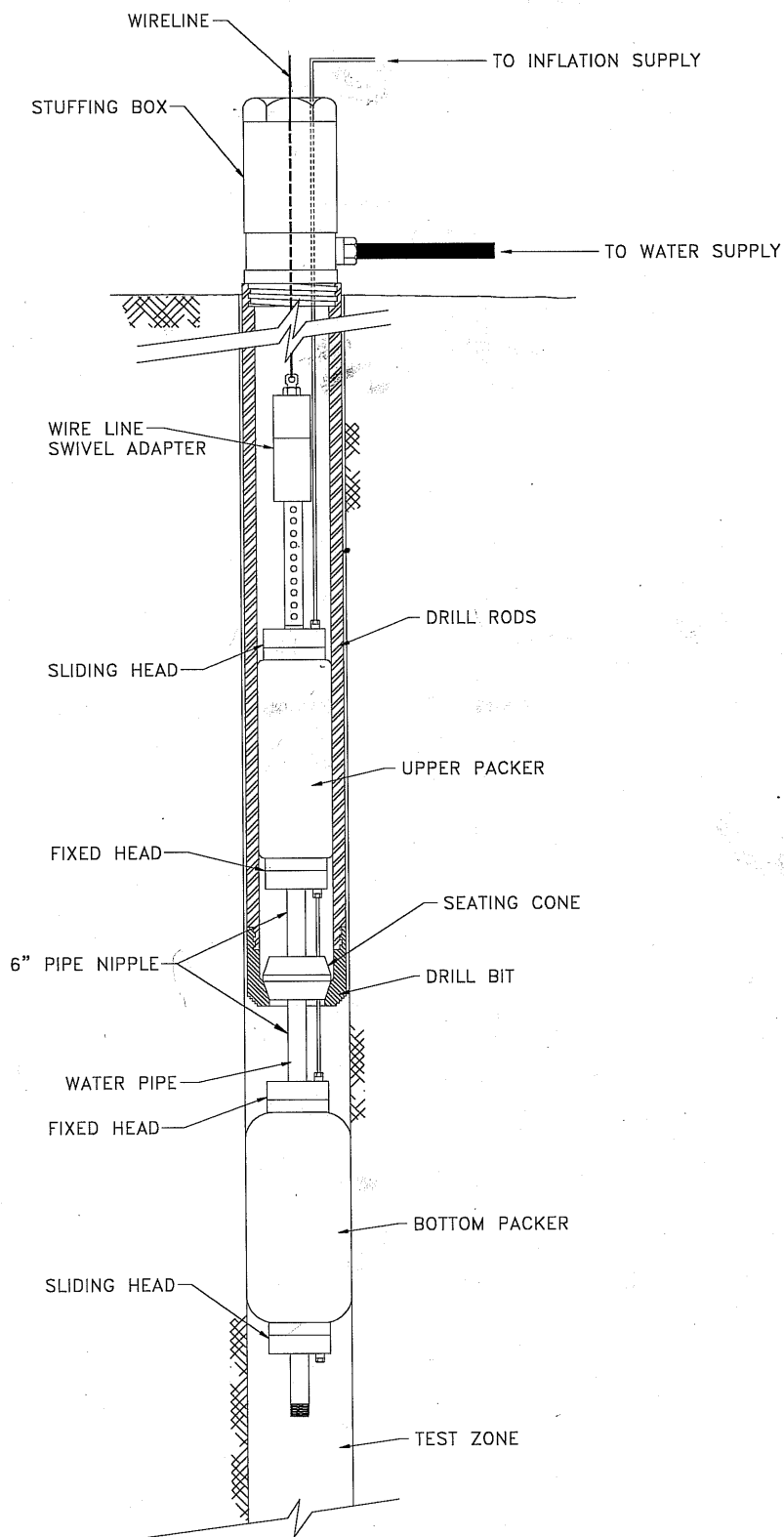

Figure 2: Wireline Double Packer Setup

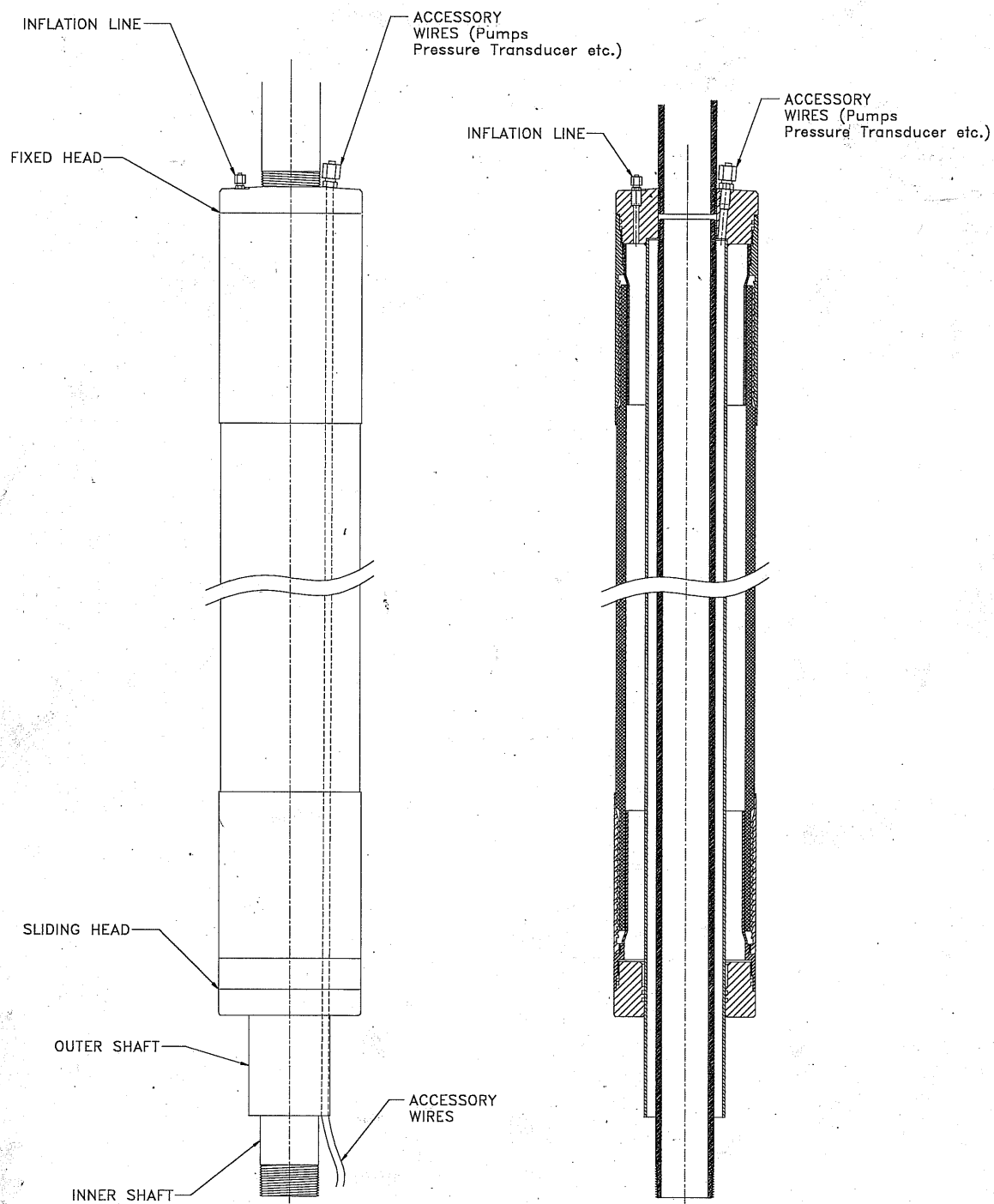

Figure 3: Double Shafted Packer

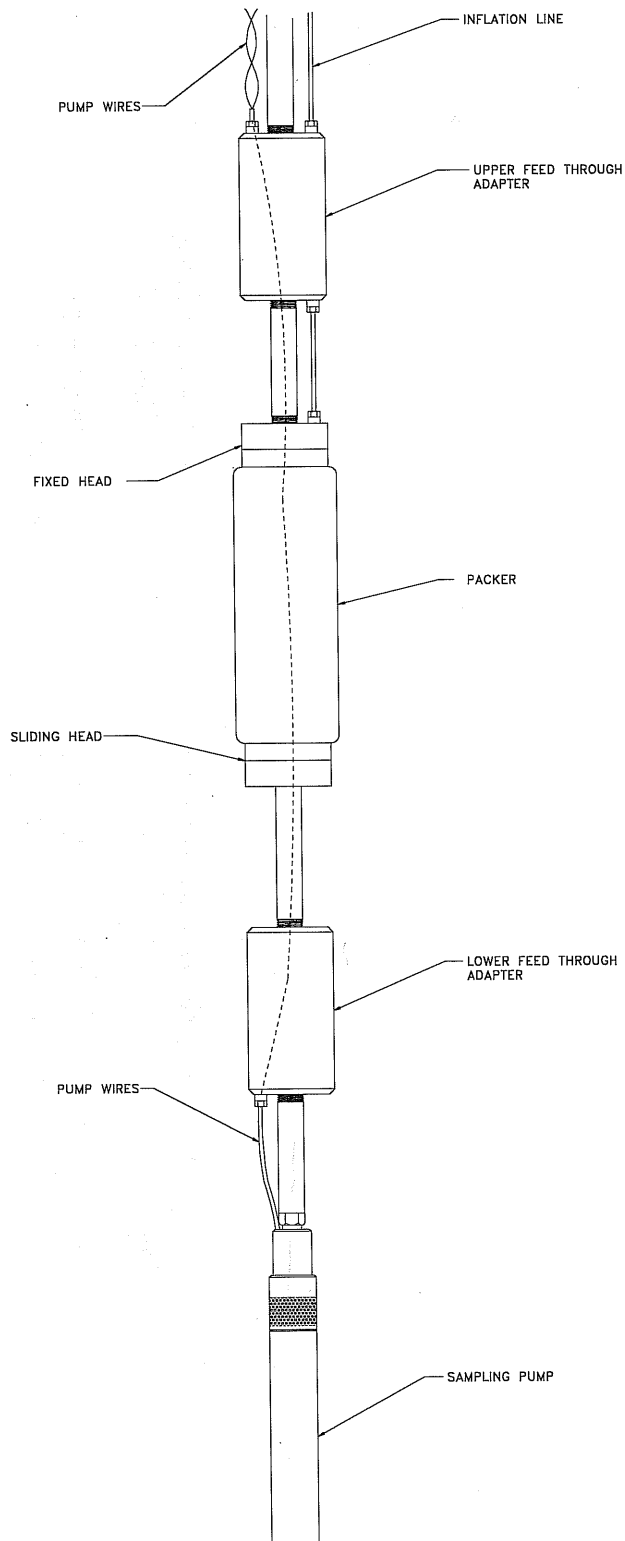

Figure 4: Sampling Pump Setup

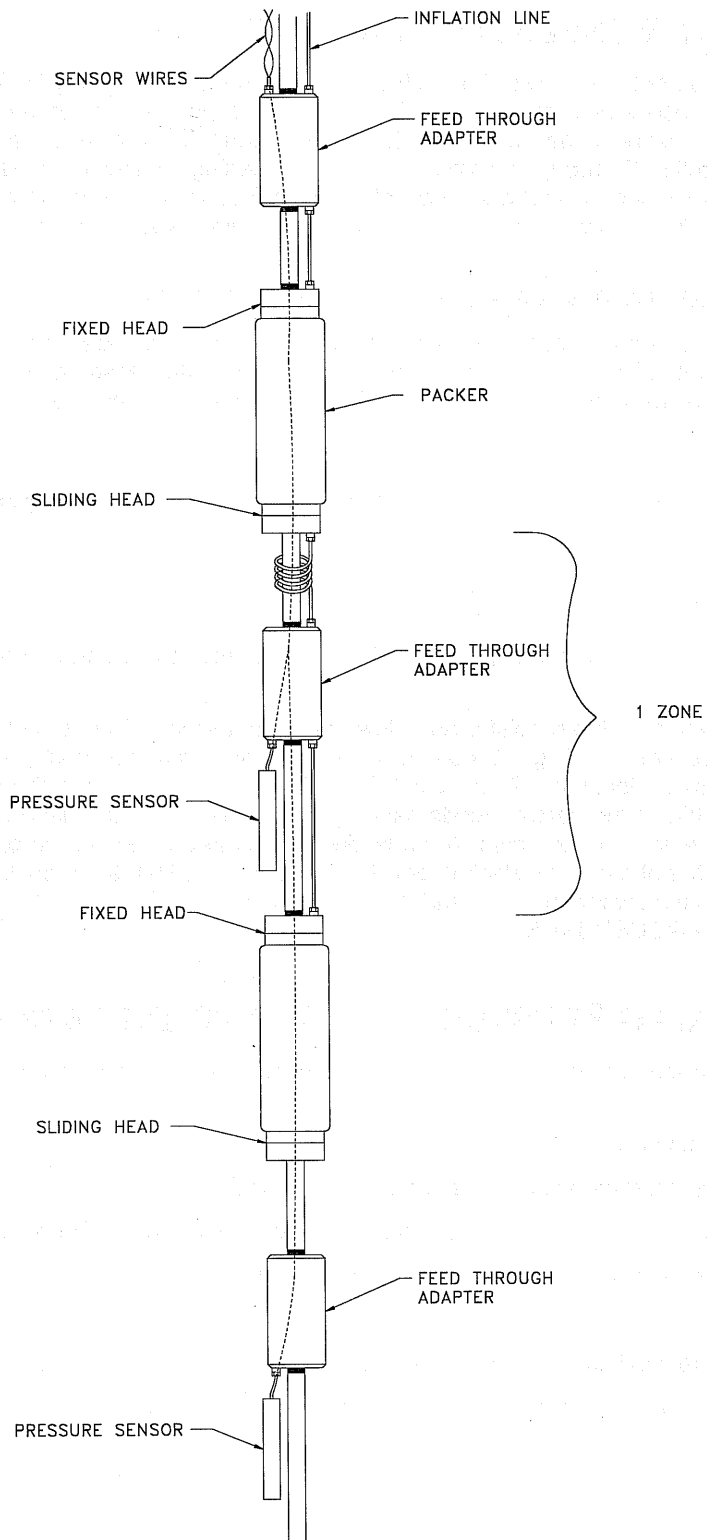

Figure 5: Pressure Sensor Setup

3 LOWERING & INFLATING THE PACKERS

When the packers are being lowered, tape the air line to the wire-line every 20-25' allowing no slack, except for the six inches of slack immediately above the top packer. Lower the packer wire until you feel or hear the seating cone clunk into the bit. Calculate the pressure needed for sealing the borehole (see Section 5). **Slowly** inflate the packer by opening the regulator gradually. The delivery pressure (pressure in the air line) gauge will show a gradual upward movement and you will hear air escaping into the line. Allow 50psi of air into the line at a time, adding air only when the hissing has subsided.

DO NOT GIVE THE SYSTEM A BIG SHOT OF AIR ALL AT ONCE.

After the delivery pressure gauge reads the appropriate pressure, close the regulator. The bottle pressure gauge will fall but the delivery pressure should remain constant. If the delivery pressure needle falls, it means there is a leak in the inflation system somewhere - a poor air fitting, for example.

NOTE: The inflation procedure may take up to 20 minutes, depending on the depth of the borehole and the size of the packer. DO NOT RUSH this procedure.

4 DEFLATING THE PACKERS

After the pump tests are completed, loosen off the packer stuffing box and remove the washers and rubbers.

Open the bleed valve on the regulator and allow the air to escape. The air will rush out to the hose while the packers are deflating. When no air is escaping from the hose, allow an additional 5 minutes for complete deflation. Then, GENTLY pull on the wire line and the packer should come free through the bit. If the packer heads hang up on the bit, rotate the head as slowly as you can and jiggle the wire line up and down till the packers come free.. Rewind the airline onto the reel at the same time. Do not allow any slack to develop in the airline within the rods during retrieval since it will pile up and jam between the rods and the cone or uppermost packer. DO NOT TRY TO RUSH ANY OF THESE PROCEDURES!!

5 DETERMINING PRESSURE NEEDED TO INFLATE PACKERS

Use the following formula to determine the pressure needed to obtain a proper seal and prevent damage.

P_1 = Static head of water

P_2 = Test injection pressure at collar + head of water in shaft

$P_{p_{max}}$ = P_1 + packer maximum working pressure for hole diameter (from Packer Inflation Curve)

$P_{p_{min}}$ = P_2 + P to contact borehole wall (from Packer Inflation Curve) + 50 psi

Where $P_{p_{max}}$ is the maximum safe pressure before damage to the packer can occur

Where $P_{p_{min}}$ is the minimum pressure to insure proper seal and prevent slippage

Inflation pressure needed, P_i , should be:

$$P_{p_{max}} > P_i > P_{p_{min}}$$

e.g.: M45 packer in a 2.5" hole. Packer set at 900 feet. Static water level above packer 700 ft. test injection pressure at collar 100psi.

Therefore, $P_1 = 700 (0.43) = 301\text{psi}$

$P_2 = 100\text{psi} + 900 (0.43) = 487\text{psi}$

$P_{\text{pmax}} = 301\text{psi} + 1350\text{psi} = 1651\text{psi}$

$P_{\text{pmin}} = 487\text{psi} + 120\text{psi} + 50\text{psi} = 657\text{psi}$

Therefore choose an inflation pressure, P_i , of $1651 > P_i > 657$

6 REVIEW

- a) Thread Packer Stuffing Box in Top Rod.
- b) Lower the Packers.
- c) Inflate Packers.
- d) Fill Rods with Water.
- e) Tighten Down Packing Nut on Stuffing Box.
- f) Begin Tests Under Engineer's Instructions.
- g) Deflate Packers
- h) Retrieve Packers
- i) Check Glands for Tears or Blisters Before Re-inserting.
- j) Repeat steps A thru I for Next Test.

7 SAFETY

In the interest of safety, the following points should be carefully noted.

- 1) These packers are high-pressure devices, designed to operate at high internal pressures. Under no circumstance should they be inflated above the maximum unconfined working pressure given in the packer specifications in an unconfined situation. e.g: In the open, when testing air line connections for leaks, etc.
- 2) The packers should never be inflated, even partially, without ensuring that a pipe coupling, or bushing, or some such restraining device is screwed on the end of the 3/8 NPT shaft which protrudes through the sliding packer head. This is so that in the event of the rubber gland having been damaged, the sliding head cannot fly off if the gland fails.
- 3) When the packers are in place down the hole, and fully inflated, never stand in the line with the opening of the hole. If, because of damage or some other unforeseeable cause, the packers should fail under these conditions, material can be blown from the hole with great violence.
- 4) When assembling the system, make sure that all screw-on fittings and couplings are tight.
- 5) Inflate packers very, very gradually.

8 CHANGING THE PACKER GLAND

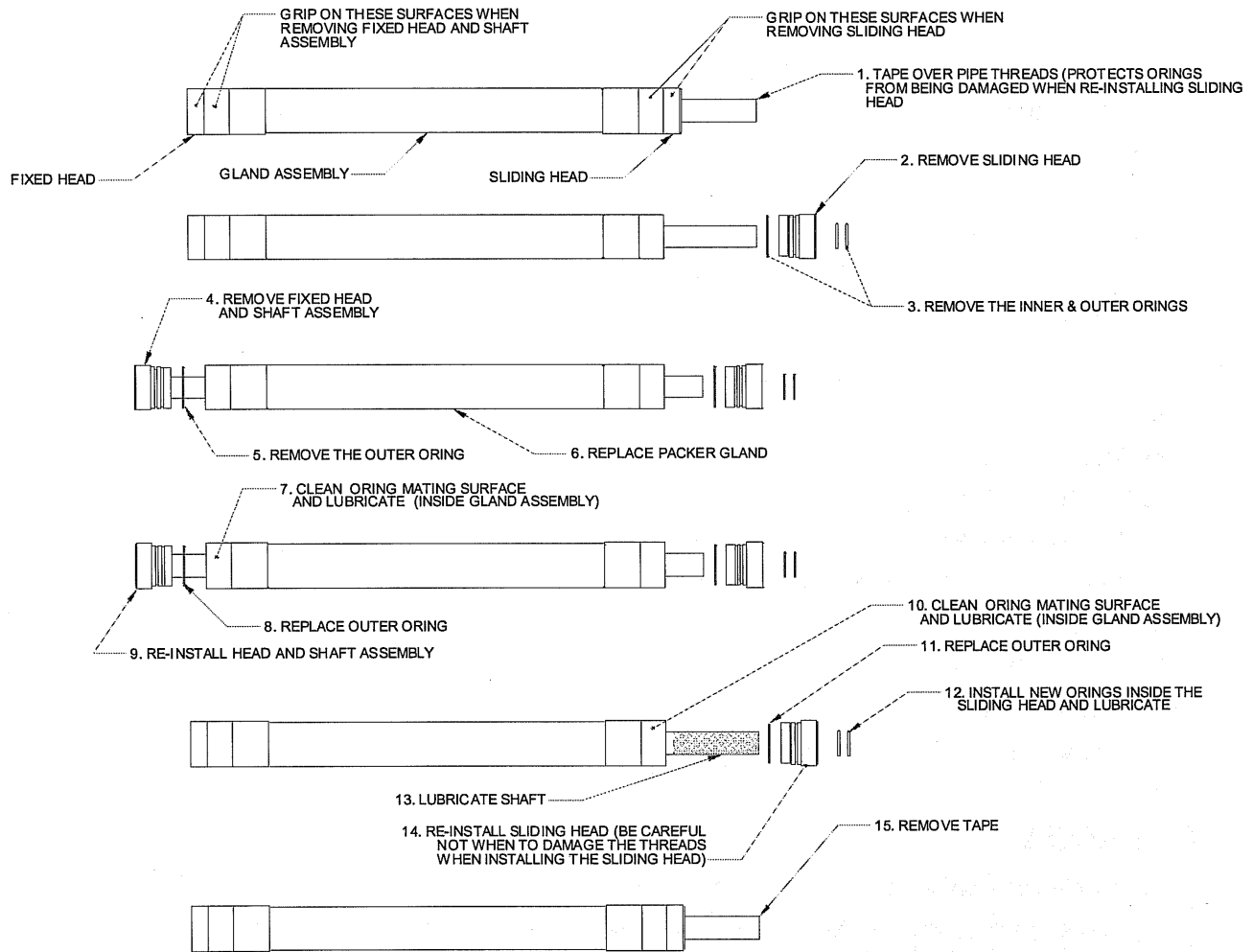

9 TROUBLE SHOOTING

The most common cause of problems with this equipment is air leaks. Make sure that all tube connections are clean before assembling, and when tightening with a wrench, use firm pressure only. DO NOT OVER TIGHTEN.

In bad ground, the system may have to be relocated elsewhere in the hole because the lower packer may not completely pack off the hole. A test to ascertain whether the lower packer is effectively packing off the hole may be done as follows: pour water through the rods until return flow is observed at the collar, around the outside of the rods. Then, with the water flow being maintained continuously, inflate the packers. If the lower packer is effectively sealing the hole, the return flow at the collar will cease.

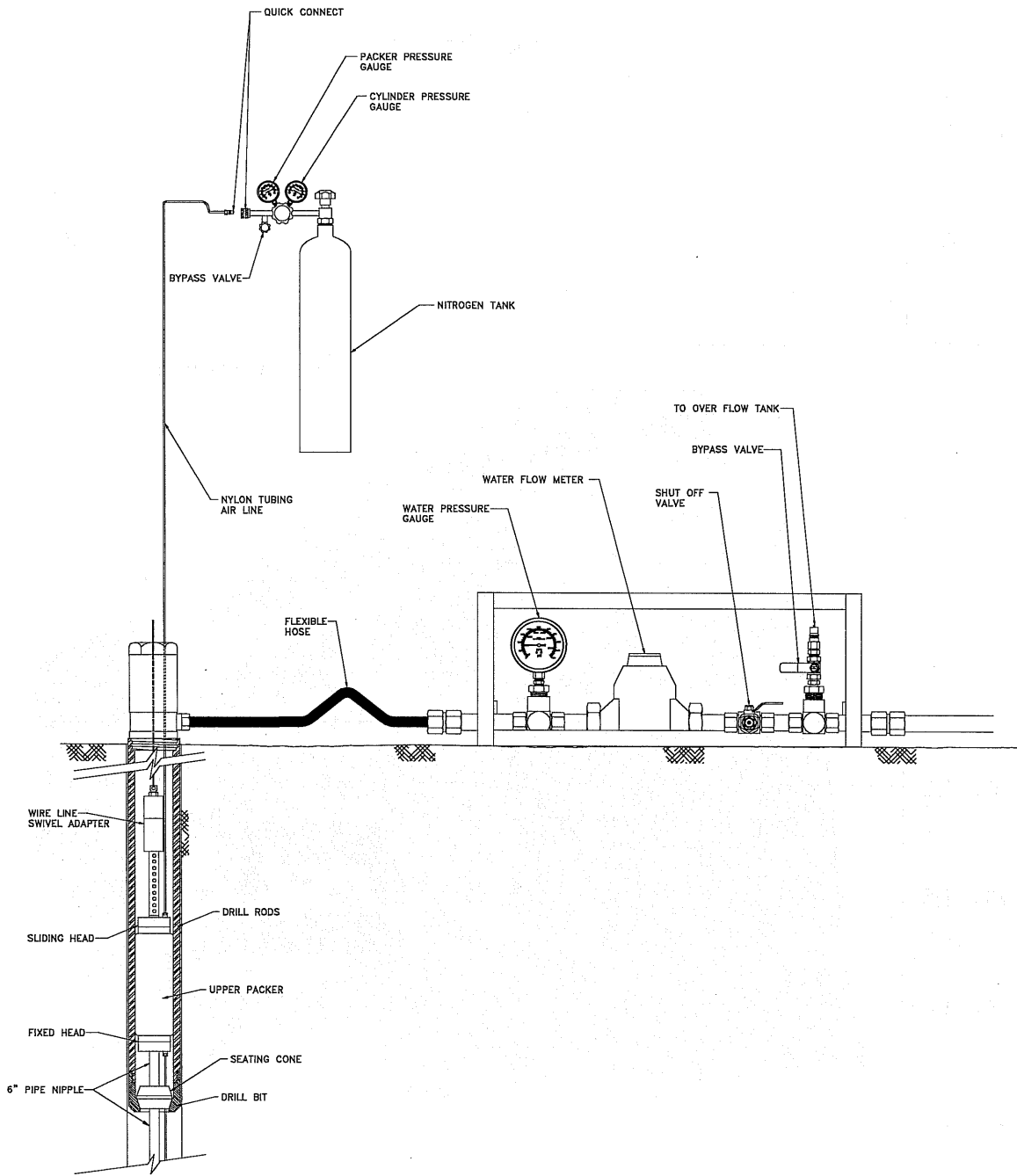

Figure 6: Packer Test Setup

M30 Packer

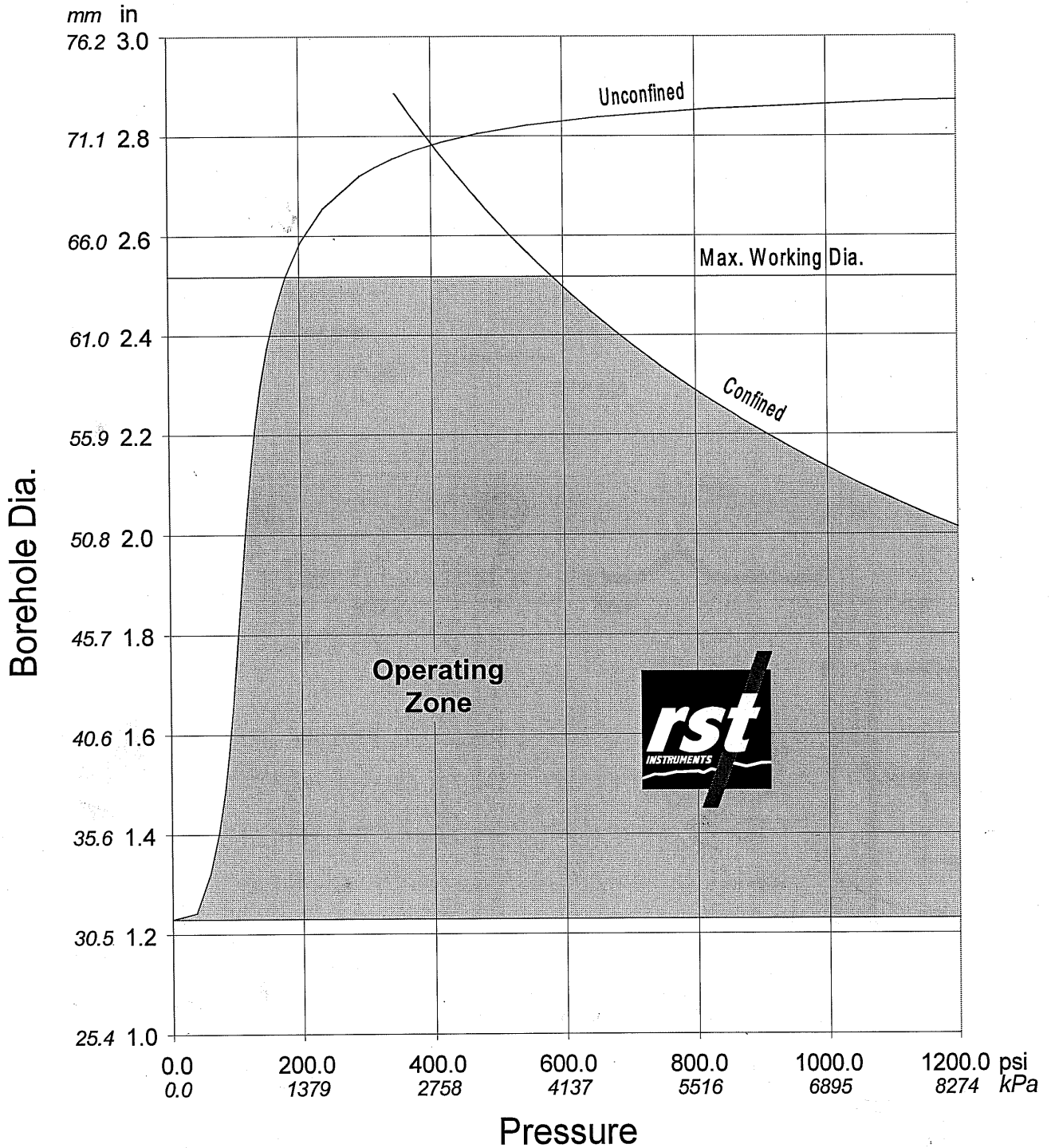

Figure 7: M30 Packer Inflation Curve

M45 Packer

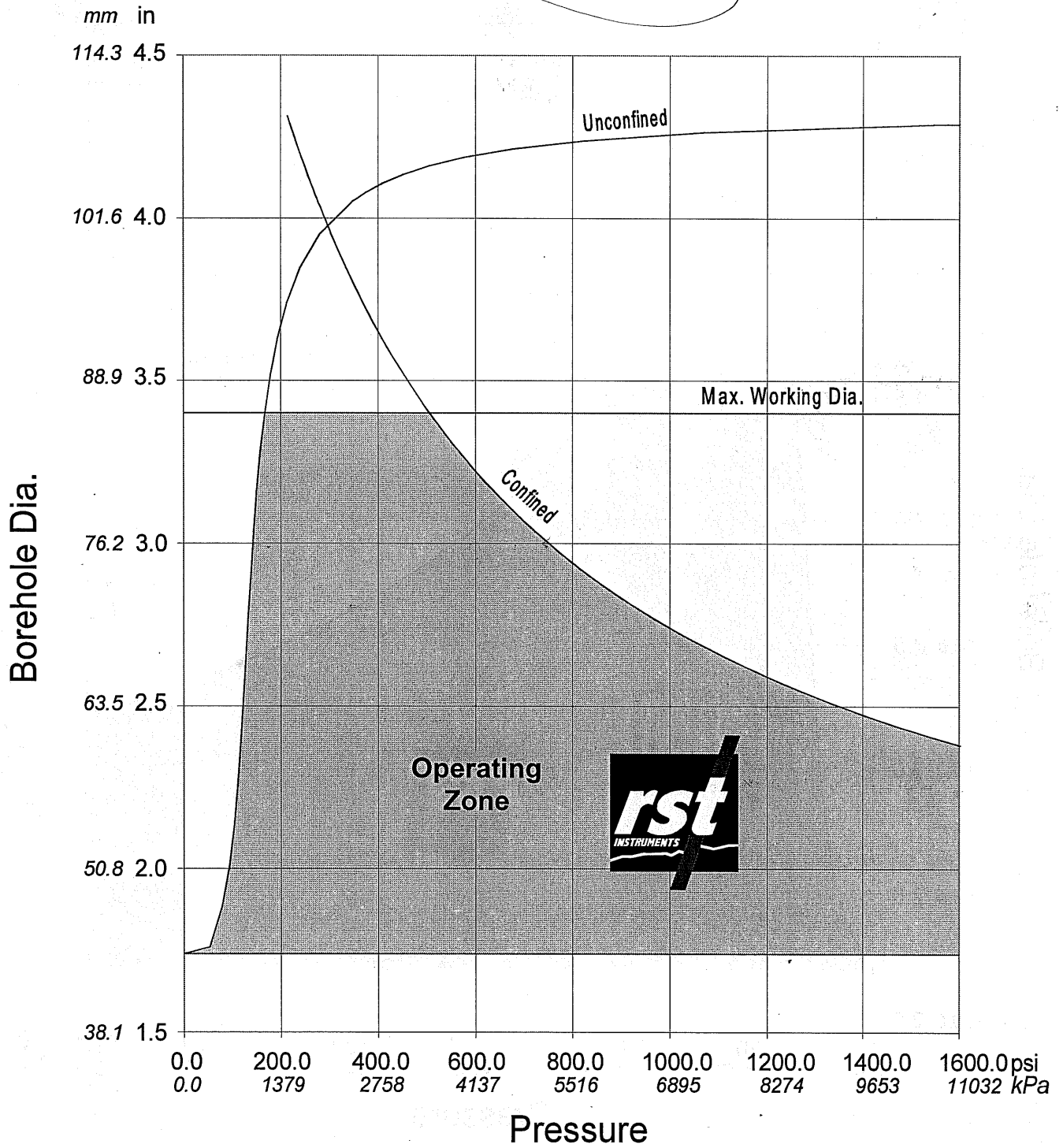

Figure 8: M45 Packer Inflation Curve

M55 Packer

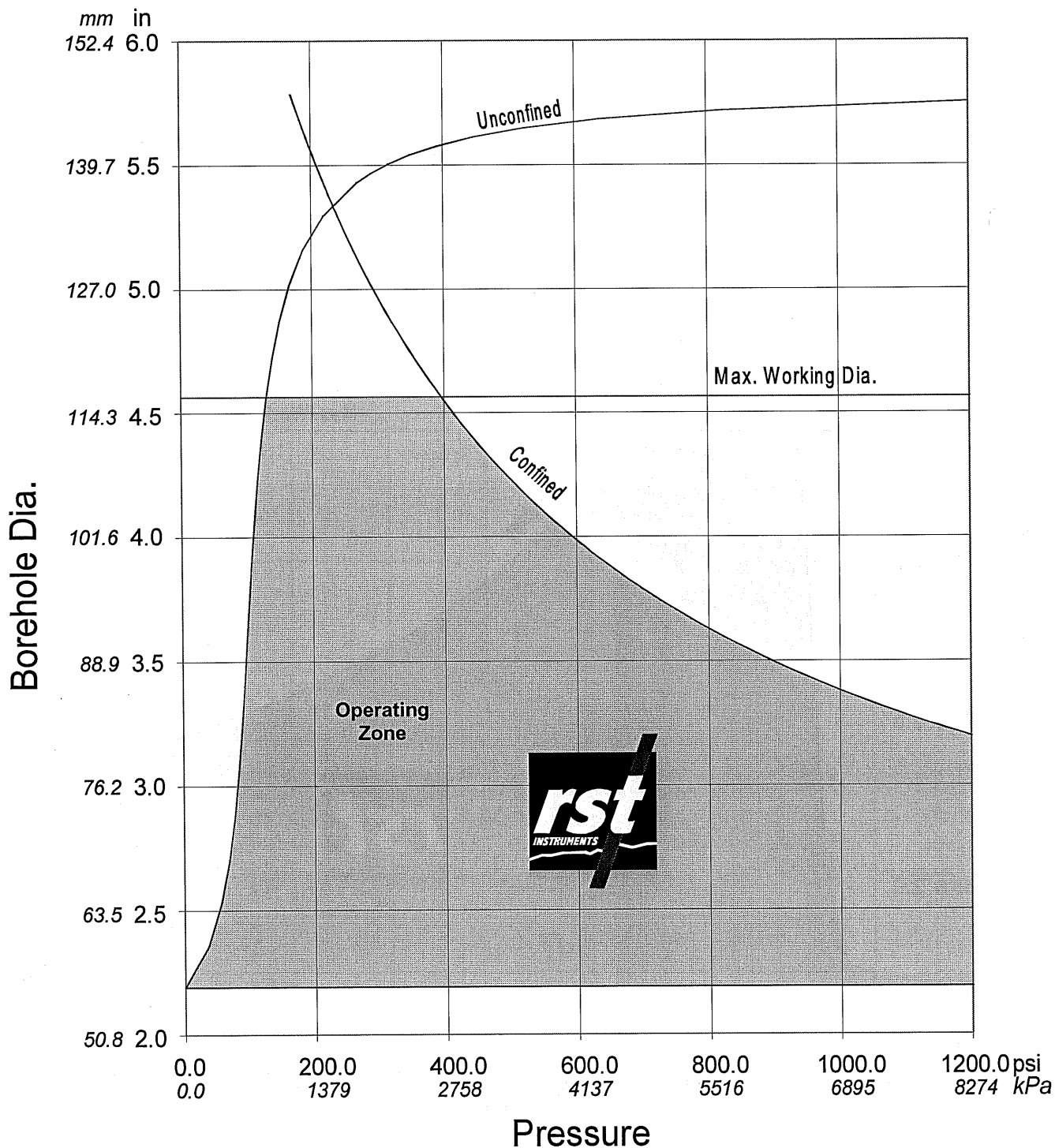

Figure 9: M55 Packer Inflation Curve

M75 Packer

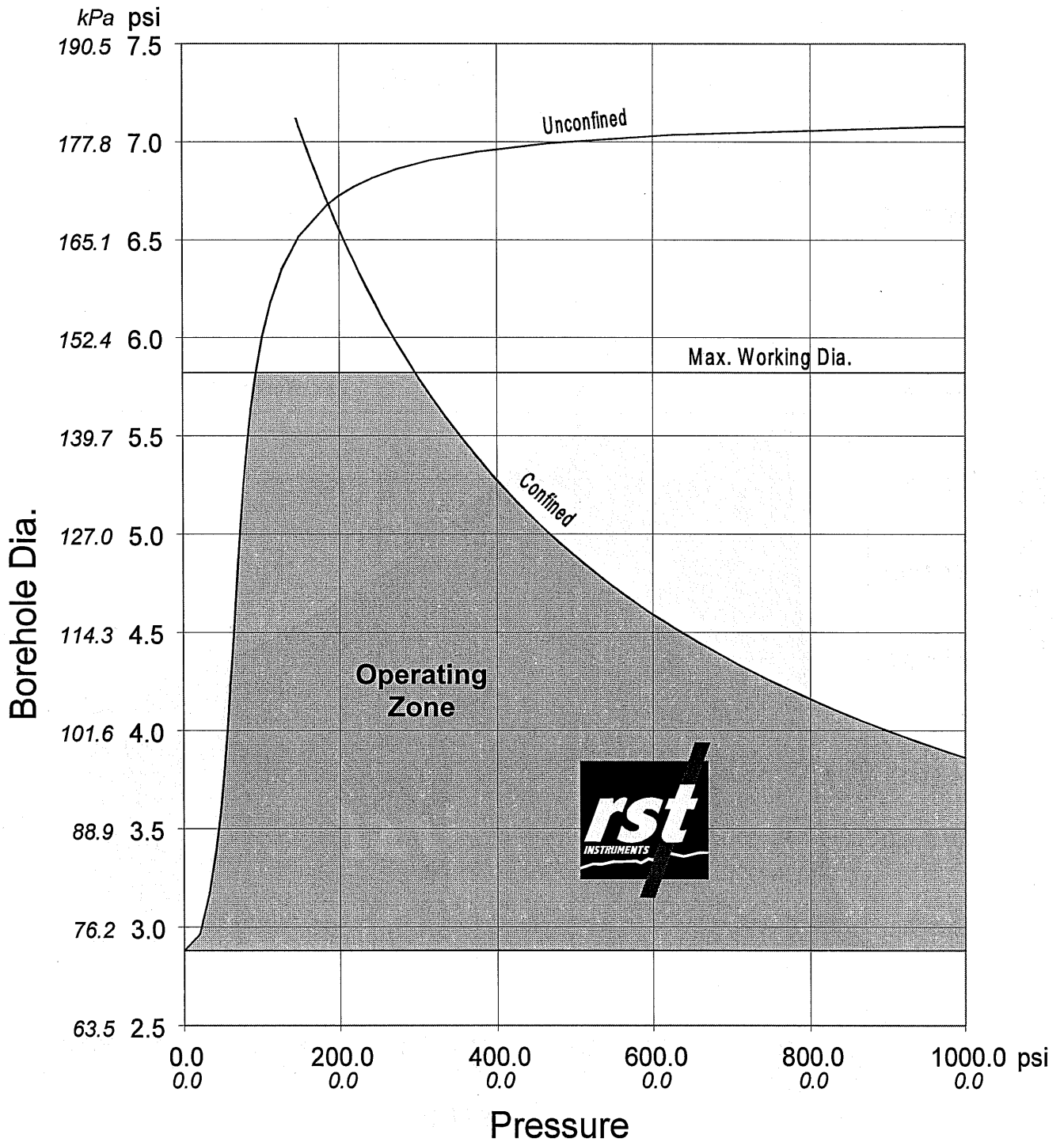

Figure 10: M75 Packer Inflation Curve

M85 Packer

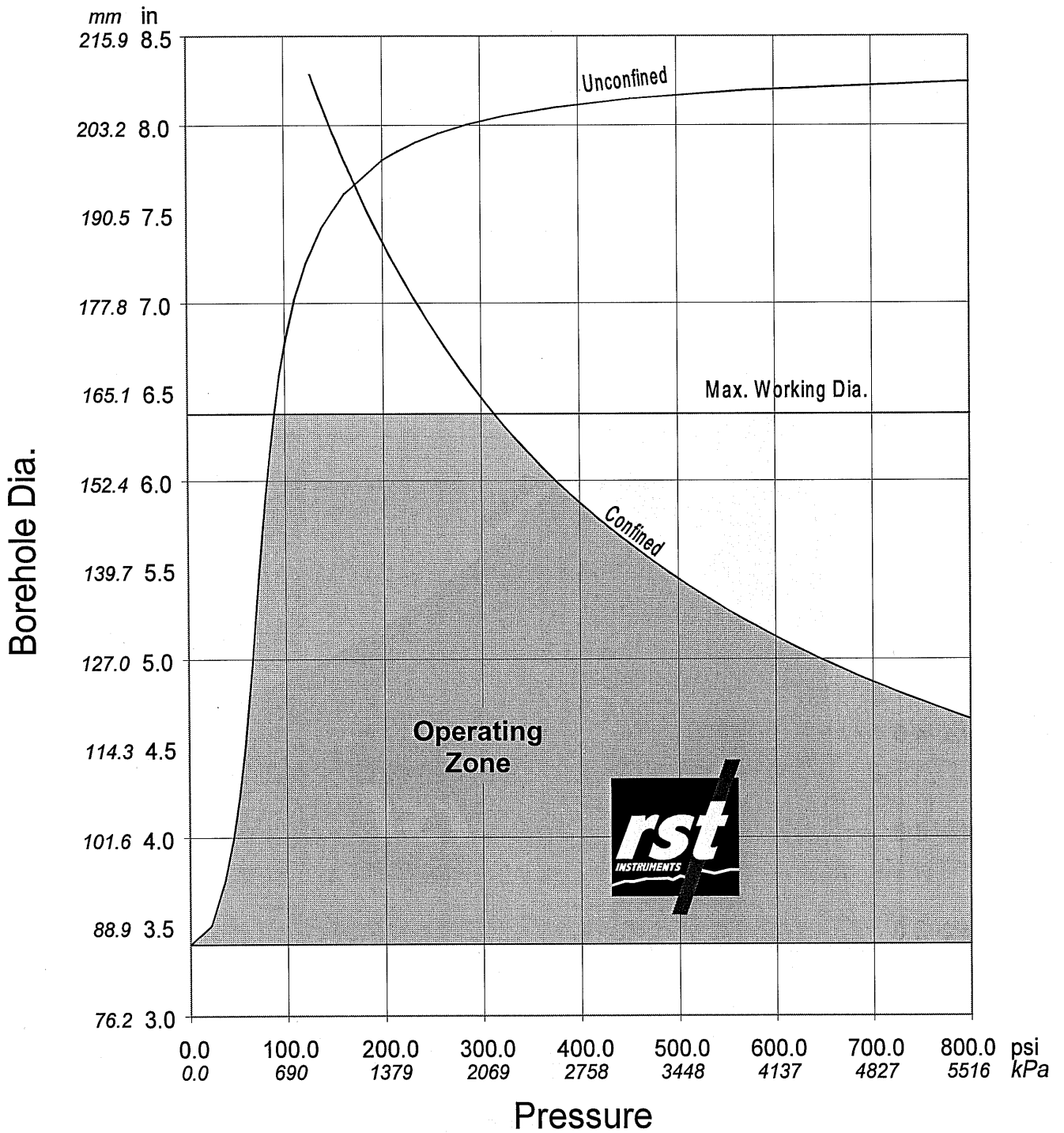

Figure 11: M85 Packer Inflation Curve

M120 Packer

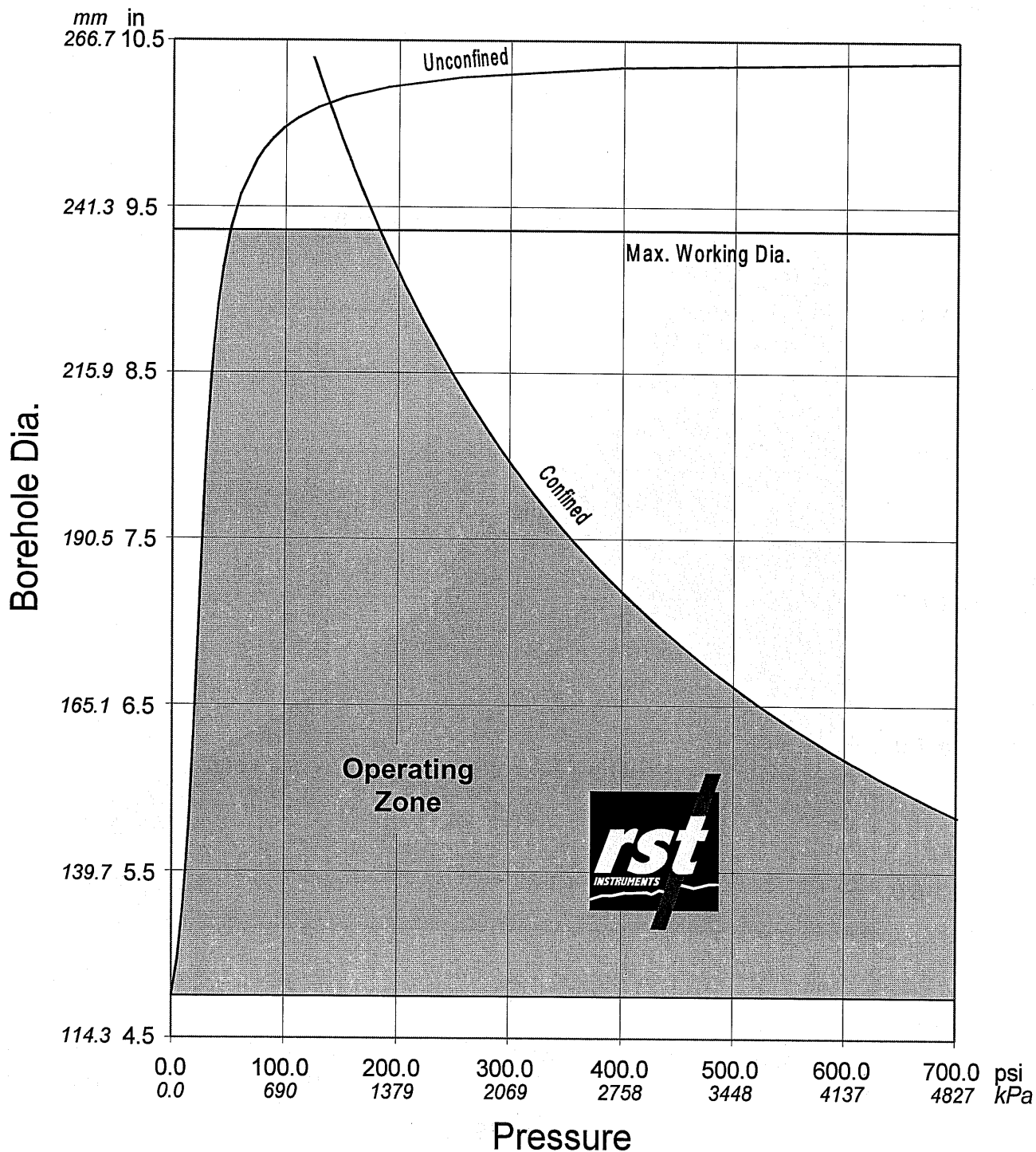

Figure 12: M120 Packer Inflation Curve

M145 Packer

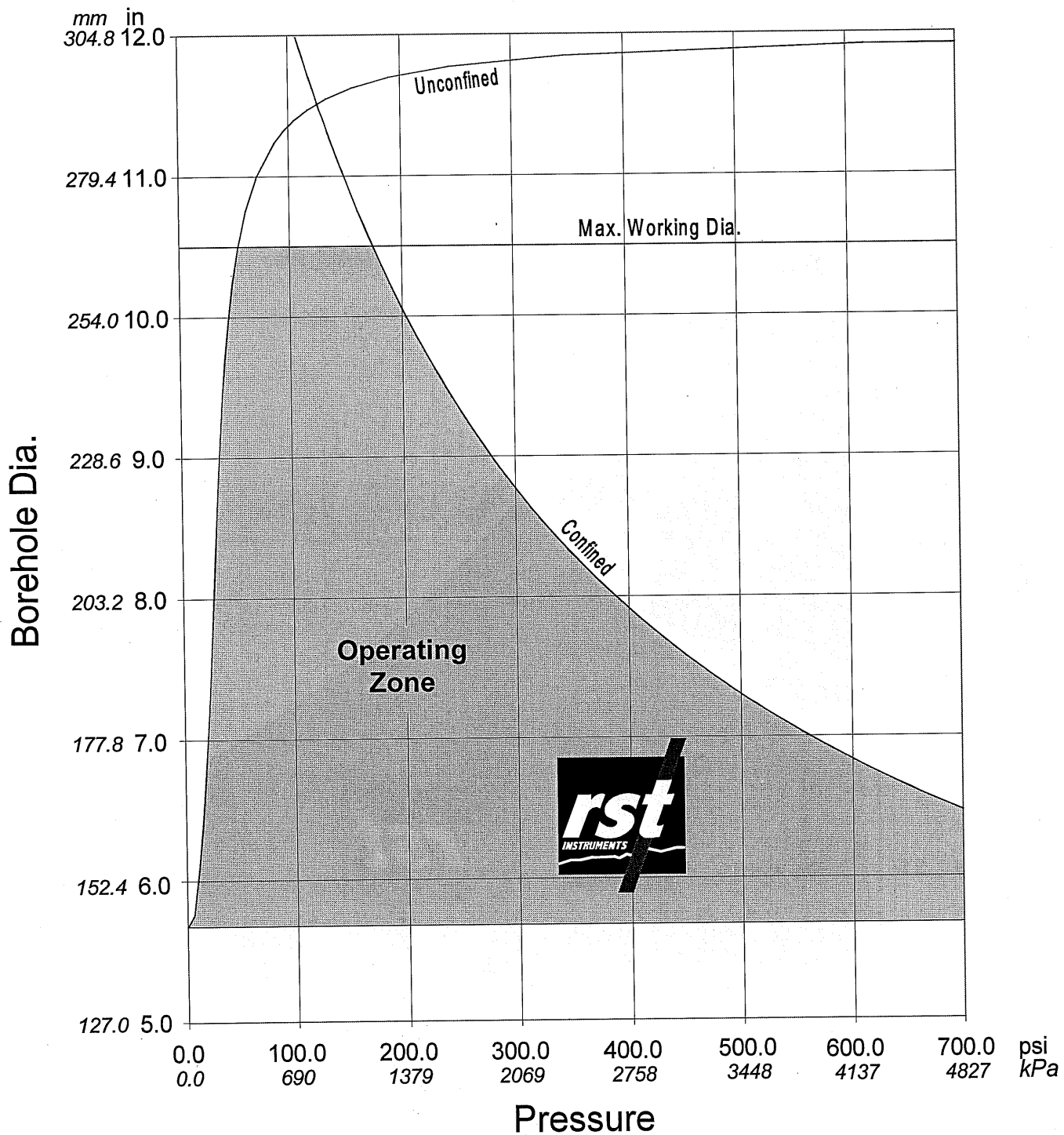

Figure 13: M145 Packer Inflation Curve

M200 Packer

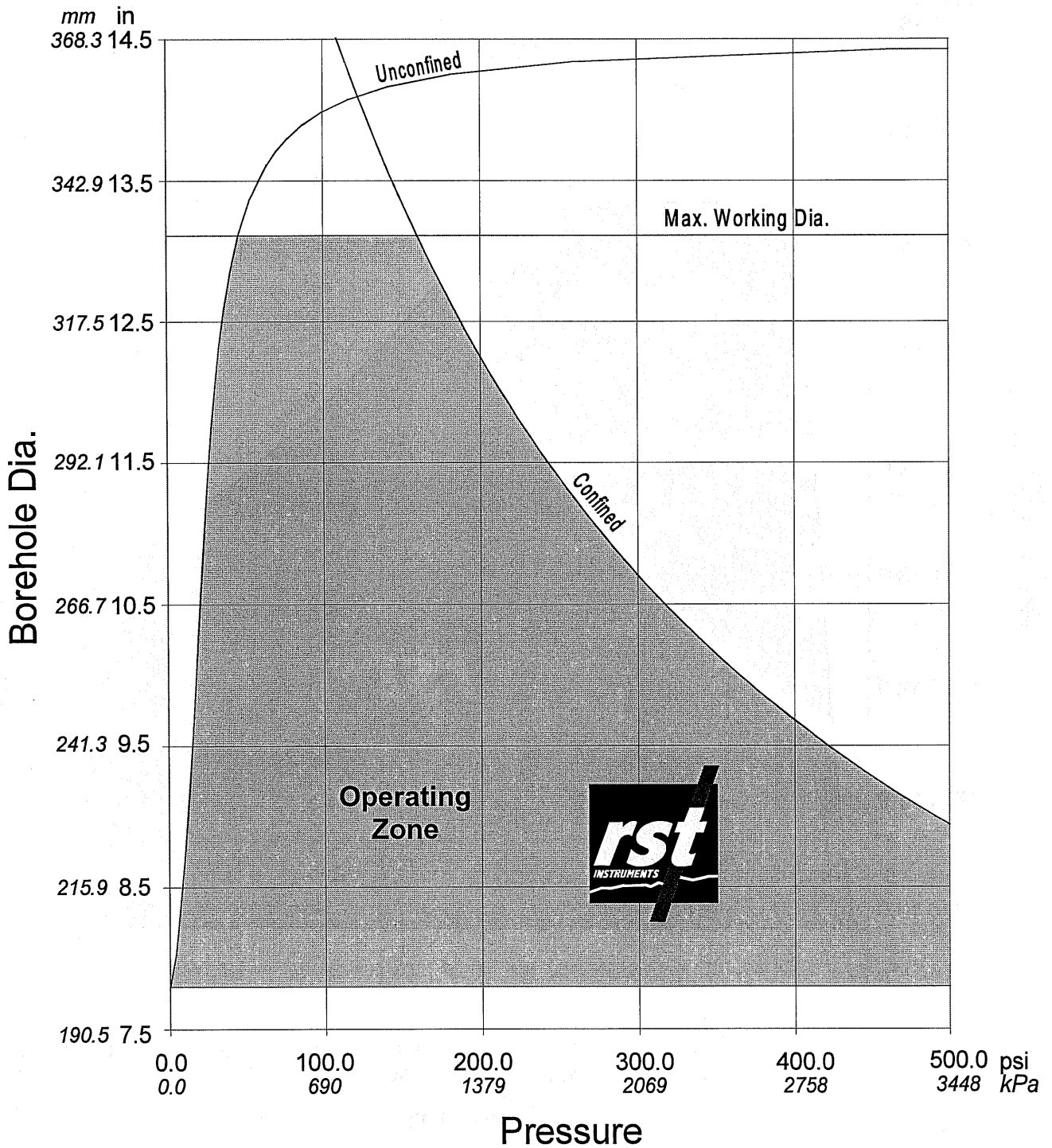

Figure 14: M200 Packer Inflation Curve

M250 Packer

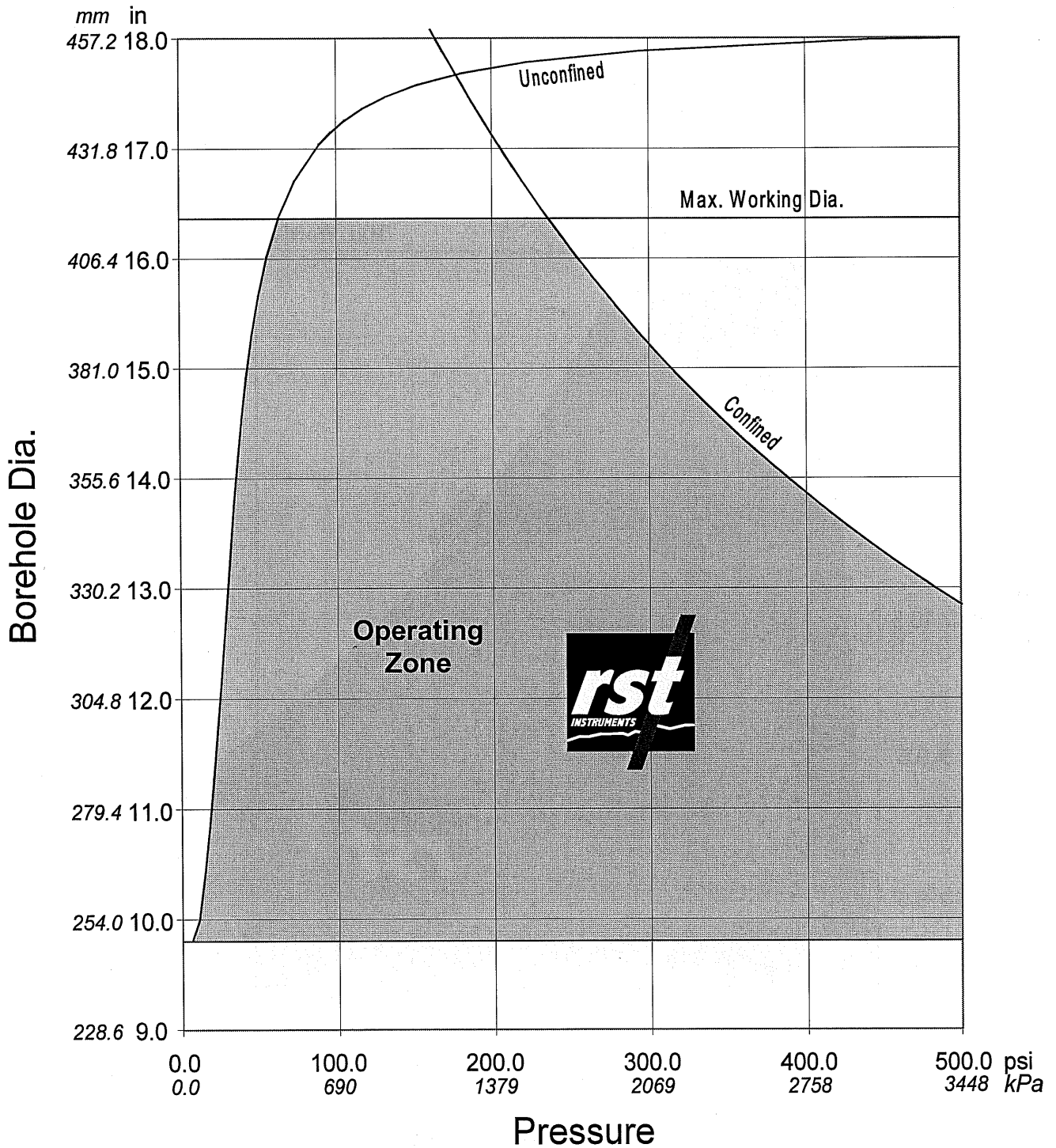

Figure 15: M250 Packer Inflation Curve

M300 Packer

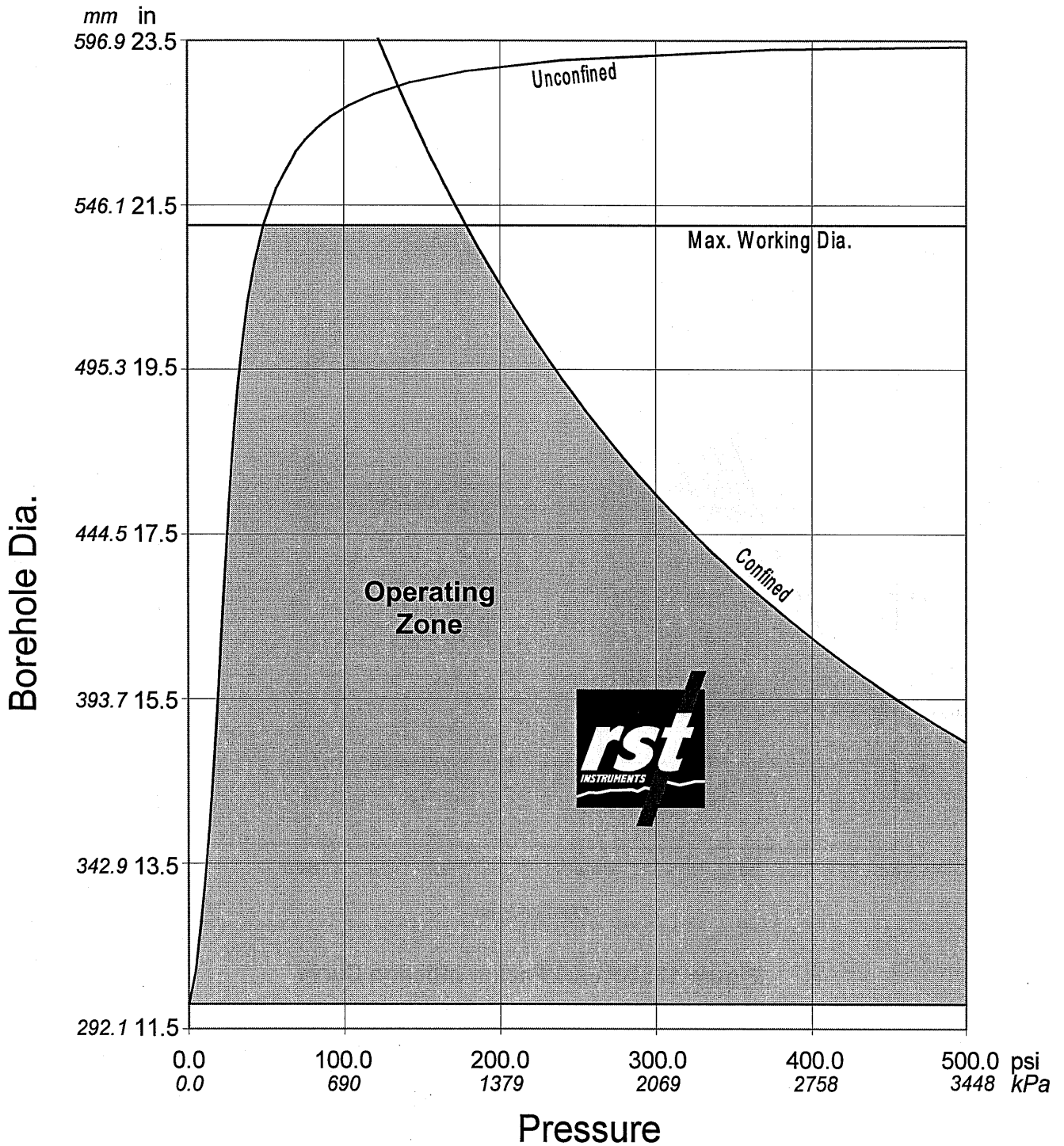

Figure 16: M300 Packer Inflation Curve

BP1000 PACKER INFLATION CURVE

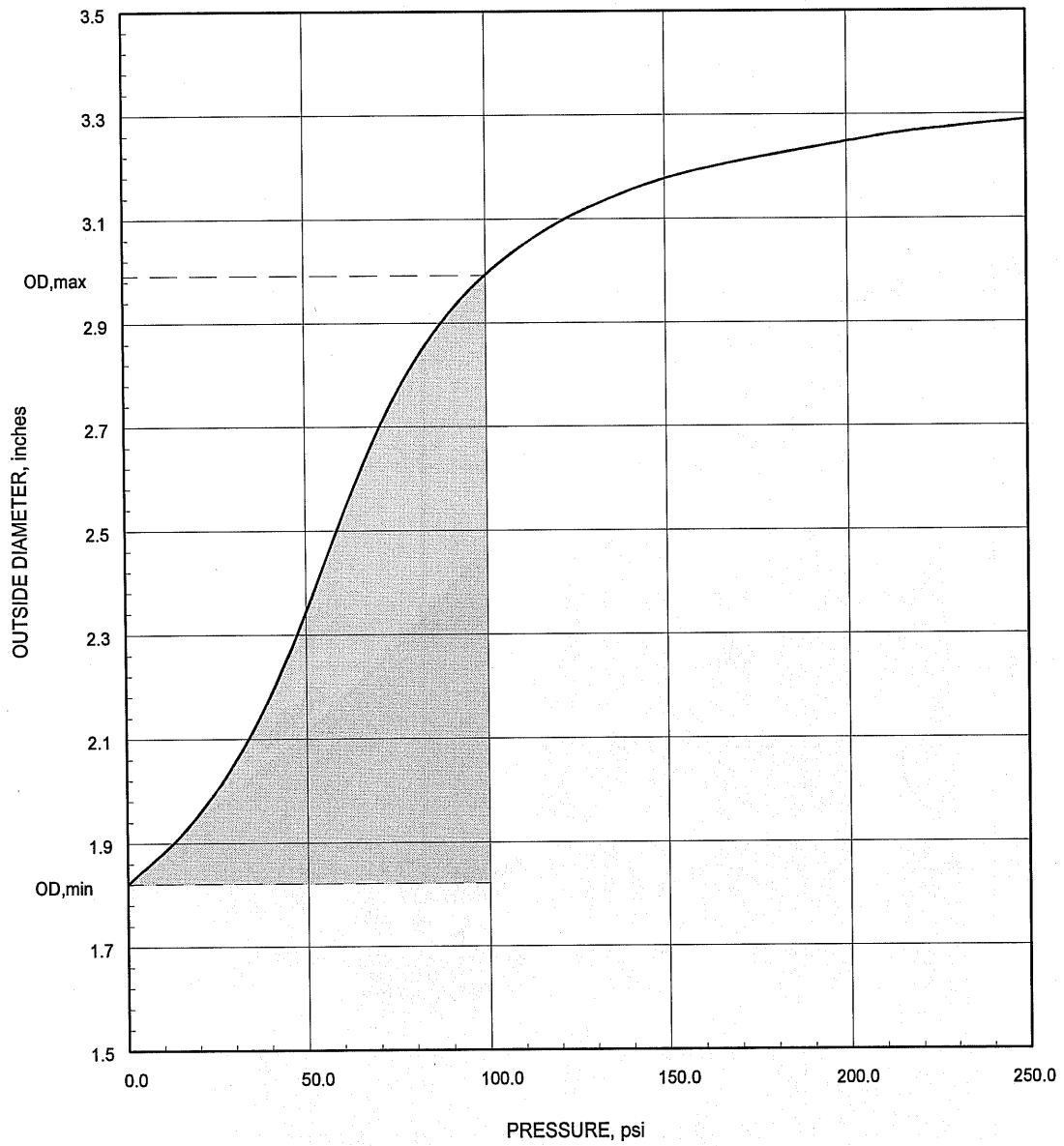

Figure 17: BP1000 Packer Inflation Curve

BP1002 PACKER INFLATION CURVE

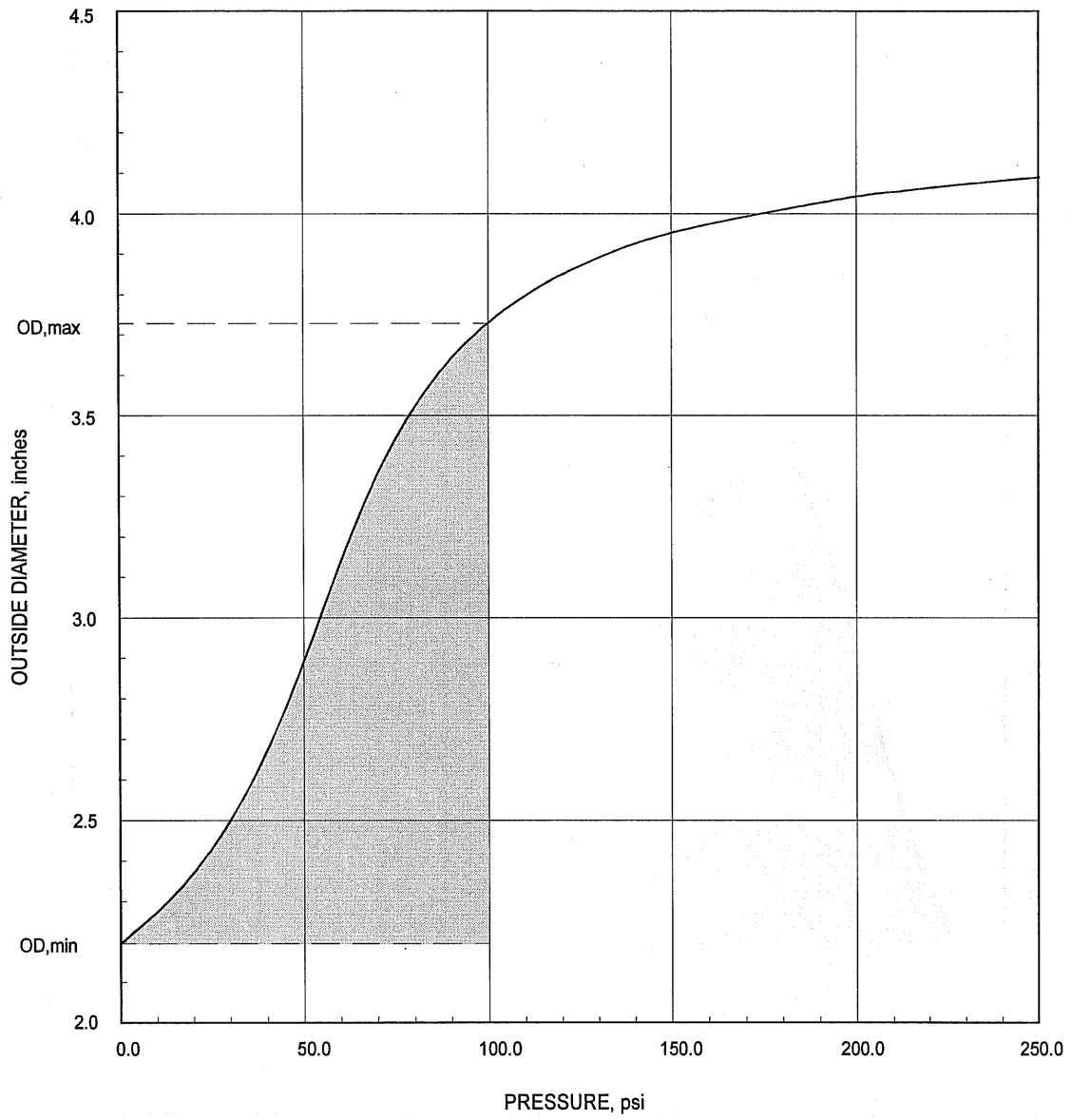

Figure 18: BP1002 Packer Inflation Curve

BP1004 PACKER INFLATION CURVE

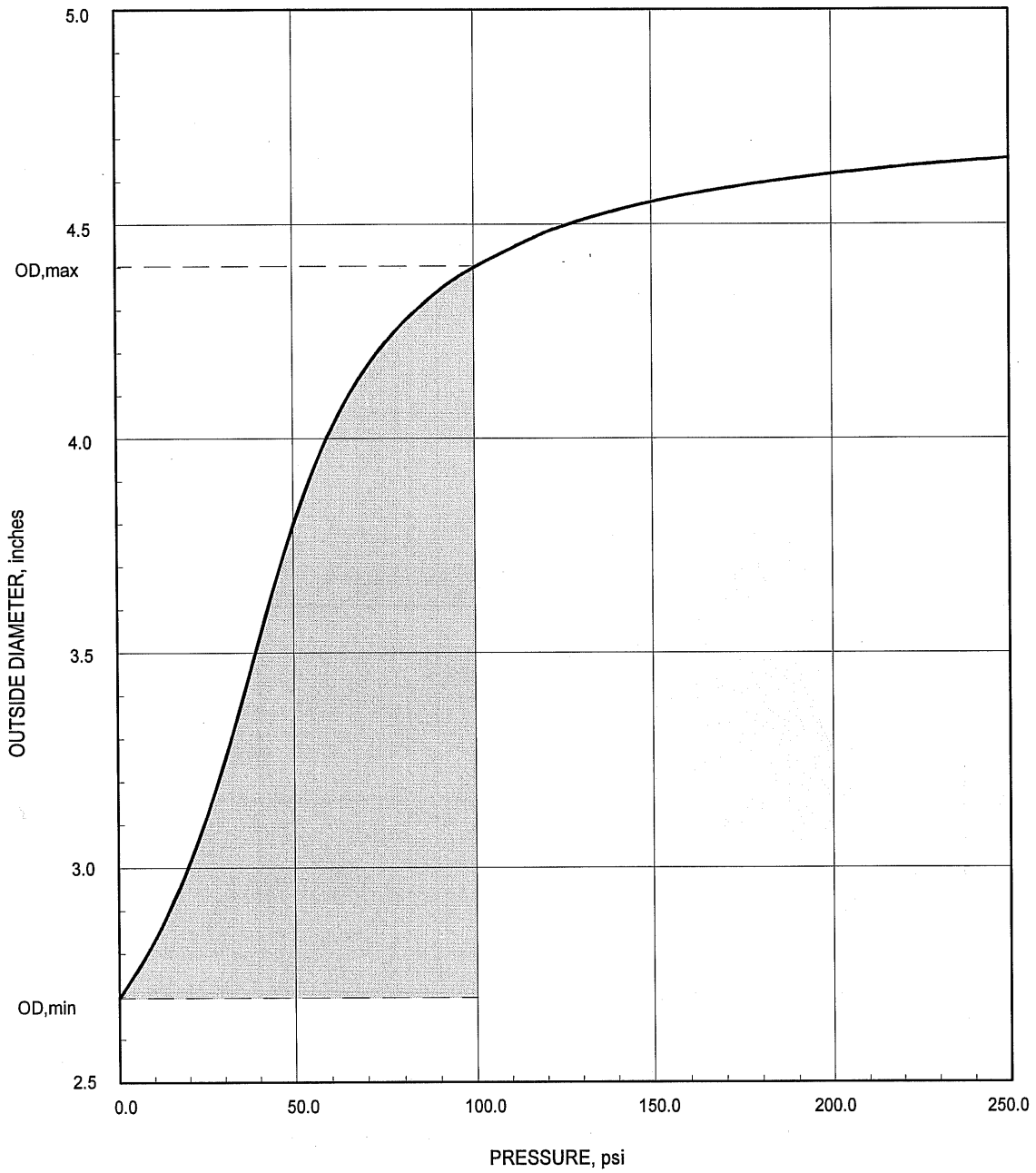

Figure 19: BP1004 Packer Inflation Curve

BP1006 PACKER INFLATION CURVE

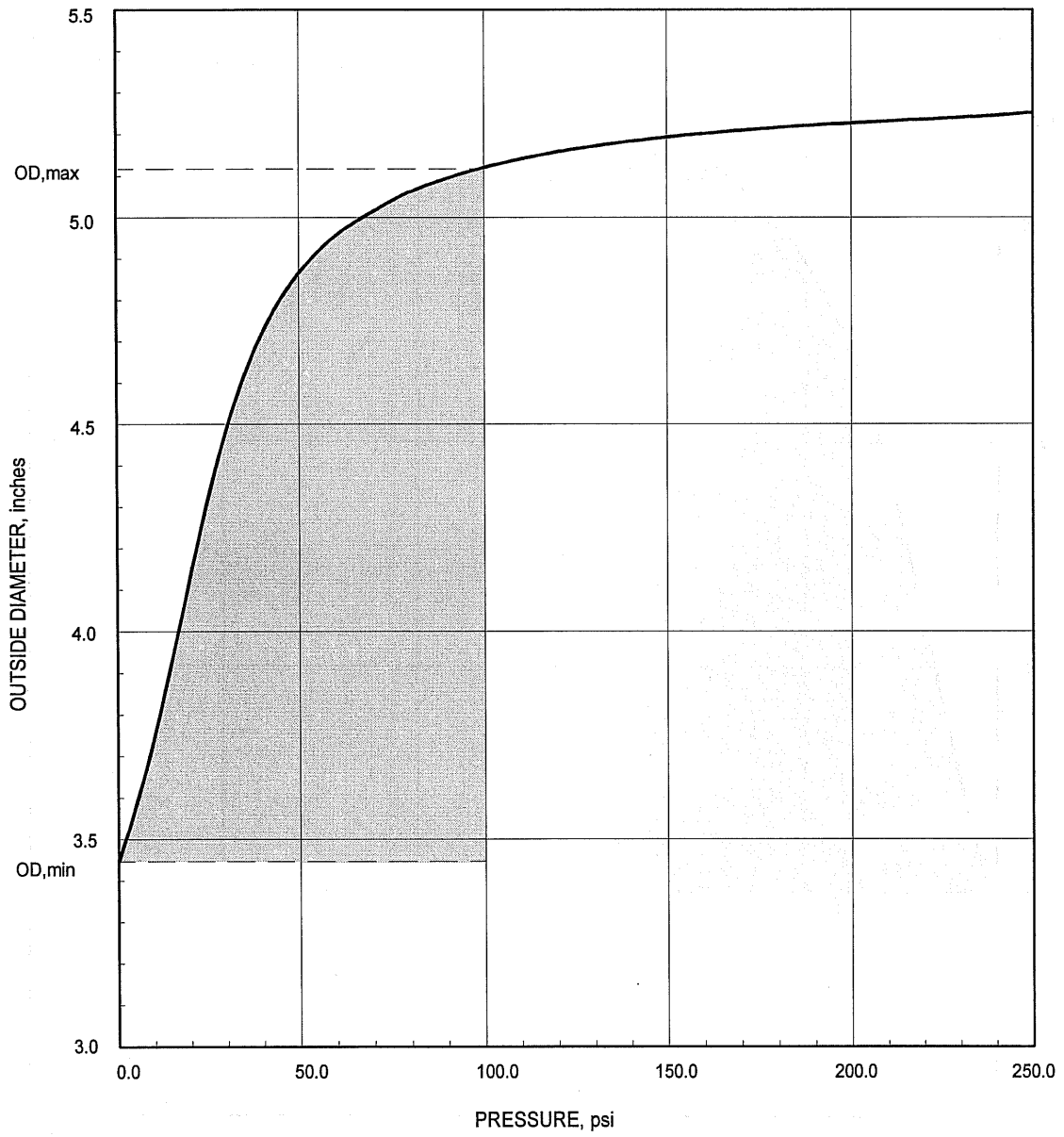

Figure 20: BP1006 Packer Inflation Curve

BP1008 PACKER INFLATION CURVE

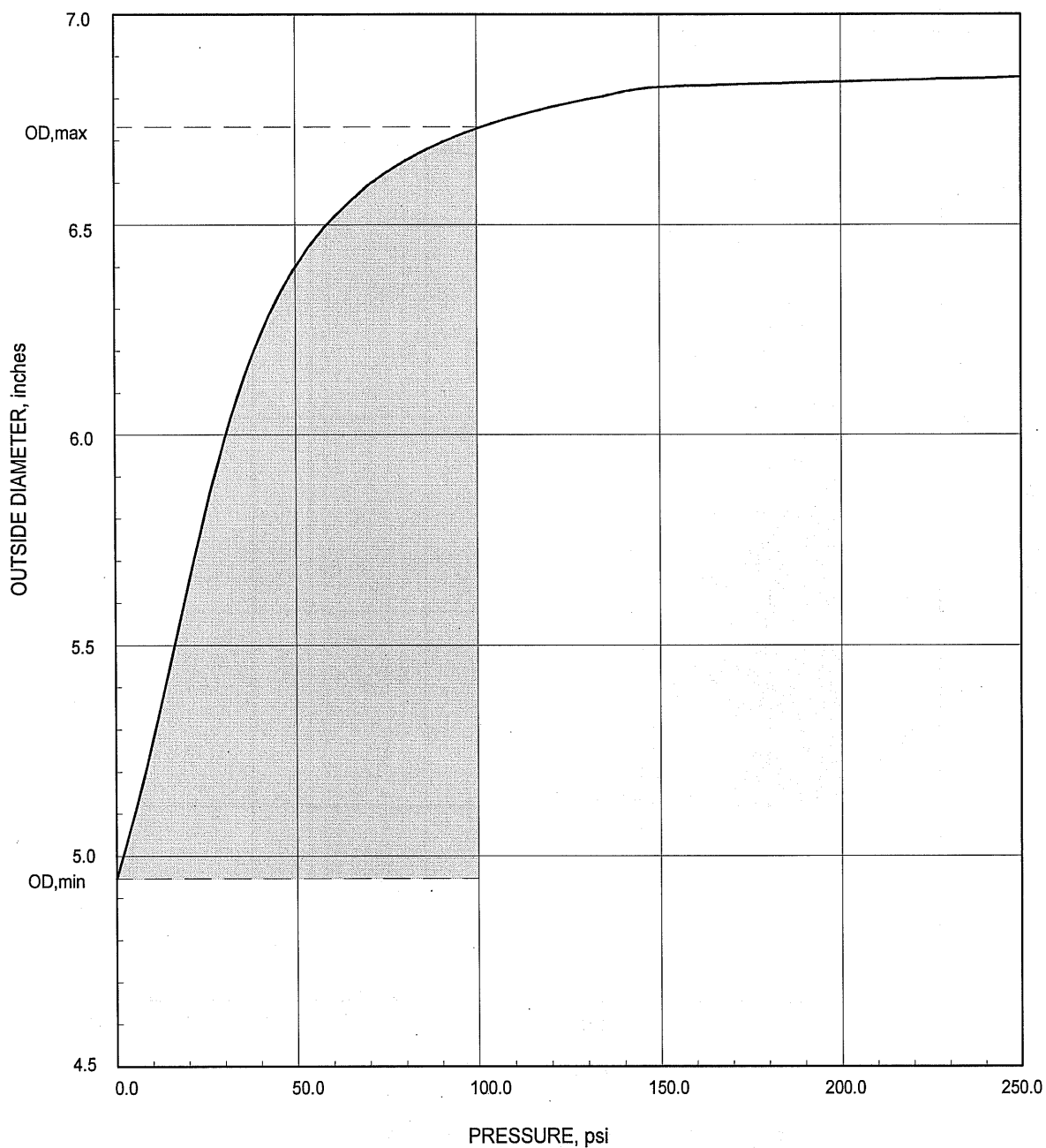

Figure 21: BP1008 Packer Inflation Curve